INSTRUCTION MANUAL
Mobile Digital 4-Channel Video Recorder

EDSR400M

V1.0



About this manual

Before installing and using this unit, please read this Manual carefully.
Be sure to keep it handy for later reference.

Safety Warning



WARNING

TO REDUCE RISK OF FIRE OR ELECTRIC SHOCK,
DO NOT EXPOSE THIS APPLIANCE TO RAIN OR MOISTURE.



CAUTION

DO NOT REMOVE COVER. NO USER SERVICEABLE PARTS INSIDE.
REFER SERVICING TO QUALIFIED SERVICE PERSONNEL.



Note:

This equipment has been tested and found to comply with the limits for a Class A digital device, The changes or modifications not expressly approved by the party responsible for compliance could void the user's authority to operate the equipment.



Note:

This is a class A product. In a domestic environment this product may cause radio interference In which case the user may be required to take adequate measures.

Notice:

The information in this manual was current when published. The manufacturer reserves the right to revise and improve its products. All specifications are therefore subject to change without notice.

Safety Precautions

Safety Precautions



⚠ Refer all work related to the installation of this product to qualified service personnel or system installers.



⚠ Do not block the ventilation opening or slots on the cover.



⚠ Do not drop metallic parts through slots. This could permanently damage the appliance. Turn the power off immediately and contact qualified service personnel for service.



⚠ Do not attempt to disassemble the appliance. To prevent electric shock, do not remove screws or covers. There are no user-serviceable parts inside. Contact qualified service personnel for maintenance. Handle the appliance with care. Do not strike or shake, as this may damage the appliance.



⚠ Do not expose the appliance to water or moisture, nor try to operate it in wet areas. Do take immediate action if the appliance becomes wet. Turn the power off and refer servicing to qualified service personnel. Moisture may damage the appliance and also cause electric shock.



⚠ Do not use strong or abrasive detergents when cleaning the appliance body. Use a dry cloth to clean the appliance when it is dirty. When the dirt is hard to remove, use a mild detergent and wipe gently.



⚠ Do not overload outlets and extension cords as this may result in a risk of fire or electric shock.



⚠ Do not operate the appliance beyond its specified temperature, humidity or power source ratings. Do not use the appliance in an extreme environment where high temperature or high humidity exists. Use the appliance at temperature within indoor type DVR for 0°C ~ +40°C / outdoor type DVR for 0°C ~ +50°C.

The input power source for this appliance is DC12~24V

Safety Precautions

Safety Precautions



The lightning flash with an arrowhead symbol, within an equilateral triangle, is intended to alert the user to the presence of uninsulated "dangerous voltage" within the product's enclosure that may be of sufficient magnitude to constitute a risk of electric shock to persons



Warning:
Electrostatic-sensitive device. Use proper CMOS/MOSFET handling precautions to avoid electrostatic discharge.



The exclamation point within an equilateral triangle is intended to alert the user to presence of important operating and maintenance(servicing)instructions in the literature accompanying the appliance.



Do not place on uneven or unstable work surfaces.
Seek servicing if the casing.



Warning :
To prevent fire or shock hazard, do not expose units not specifically designed for others use to rain or moisture.



Attention:
Installation should be performed by qualified service personnel only in accordance with the National Electrical Code or applicable local codes.



Power Disconnect:
Units with or without ON-OFF switches have power supplied to the unit whenever the power code is inserted into the power source; however, the unit is operational only when the ON-OFF switch is in the ON position. The power cord is the main power disconnect for all units.



External Power Supplies
Use only the recommended power supplies.
Power supplies must comply with the requirement of the latest version of IEC 60065/CNS 13439. Substitutions may damage the unit or cause a fire or shock hazard



DC12~24V Power Cords
DC12~24V power cords

Important Safeguards

Important Safeguards



Read Instruction---All the safety and operating instructions should be read before the unit is operated



Retain Instructions---The safety and operating instructions should be retained for future reference.



Heed Warnings—All warnings on the unit and in the operating instructions should be adhered to.



Follow Instructions—All operating and use instructions should be followed



Cleaning—Unplug the unit from the outlet before cleaning. Do not use liquid cleaners or aerosol cleaners.
Use a damp cloth for cleaning



Attachments—Do not use attachment not recommended by the product manufacturer as they may cause hazards.



Water and Moisture—Do not use this unit near water, in a wet basement may result in a risk of fire or electric shock.



Servicing—Do not attempt to service this unit yourself as opening or removing covers may expose you to dangerous voltage or other hazards. Refer all servicing to qualified service personnel or with the technician of the vehicle-related Before installation.



Power Cord Protection—Power supply cords should be routed so that they are not likely to be walked on or pinched by items placed upon or against them, paying particular attention to cords and plugs, convenience receptacles, and the point where they exit from the appliance.



Object and Liquid Entry—Never push objects of any kind into this unit through openings as they may touch dangerous voltage points or short-out parts that could result in a fire or electric shock, Never spill liquid of any kind on the unit.

Important Safeguards

Important Safeguards and Warnings before Installation

 For Mobile Digital Single Channel Video Recorder (single HDD)
While the DVR is connected to the 12VDC battery of the vehicle, the limited electric current is 3.0 amps with a normal electric current between 1.5~1.0 amps.

While the DVR is connected to the 24VDC battery of the vehicle, the limited electric current is 1.5 amps with a normal electric current between 0.7~1.0 amps.

 For Mobile Digital Four Channel Video Recorder (single HDD)
While the DVR is connected to the 12VDC battery of the vehicle, the limited electric current is 3.5 amps with a normal electric current between 1.5~2.0 amps.

While the DVR is connected to the 24VDC battery of the vehicle, the limited electric current is 1.6 amps with a normal electric current between 0.7~1.0 amps.

 During installation, it is important to note that the power supply for the DVR should be directly connected to the vehicle battery. Utilize a 5 - 10 amp fuse and only qualified power material designed specifically for the vehicle for best results.

 Never connect the unit directly to the power source as a high voltage surge may damage both the DVR and the vehicle. The EP2026A is equipped with electronic surge protection (up to 470V) to help protect the unit from damage.

 It is advised to operate the DVR while the car is running to minimize the power drain on the vehicle battery. Inspect the vehicle battery prior to installation to ensure maximum performance of your DVR.

 Please use 160G Maxtor Hard Disk Drives with 3.5" Hard Disk DVRs

 Please use 40G or 60G HITACHI Hard Disk Drives with 2.5" Hard Disk DVRs

 To minimize the risk of an electrical fire, it is very important to monitor the power range and electrode, while the LCD monitors and cameras are both connected to the DVR.

Quick Install Guide

- The DVR can be mounted horizontally (suspend or support mounted).

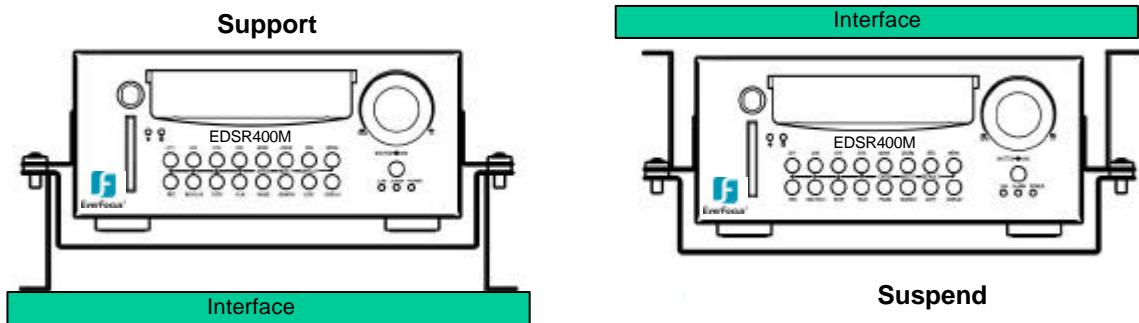

- Show all the possible ways to mount the DVR.
Use the two Z-brackets supplied to mount it in any ways shown.

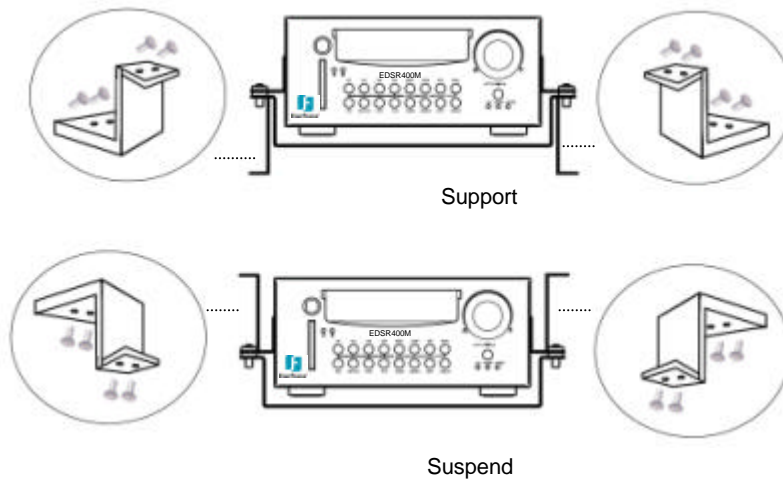

Quick Install Guide

Quick Install Guide :

■ 1. Unpack Everything

Make sure you have everything you need before you begin the installation.

■ 2. Equipment Required

The following tools may help you to complete the installation:

- Drill
- Screwdrivers
- Wire cutters

■ 3. Choosing the Location

Choose a location for installation that:

- Provide convenient access for installing or removing the hard drive
- Allows air to flow around the fan vents. Inadequate or improper air flow can impede proper operation of the unit.

Avoid any location for installation:

- That is subject to high vibration
- That is subject to high sunlight levels
- That is subject to drenched of the rain
- Where passengers can interfere with unit
- Next to a heater duct

As following table lists recommended location options.

Location	Convenient operation	Easy to install	Low vibration	Good air flow
Bottom of glove box- horizontal mount	Yes	Yes	Yes	Yes
Bottom of passenger seat next to the driver	NO	Yes	Yes	Yes
Underneath bulkhead-horizontal mount	Yes	Yes	NO	Yes
Front of bulkhead-horizontal mount	Yes	Yes	Yes	Yes
Beside deriver seat -horizontal mount	Yes	Yes	Yes	Yes

Caution: Do not install the DVR on the floor or on the transmission access hatch. These locations have the highest levels of vibration and may be subject to water damage.

Quick Install Guide

■ Possible Installation Locations Inside the Automobile Vehicle: TOYOTA CAMRY

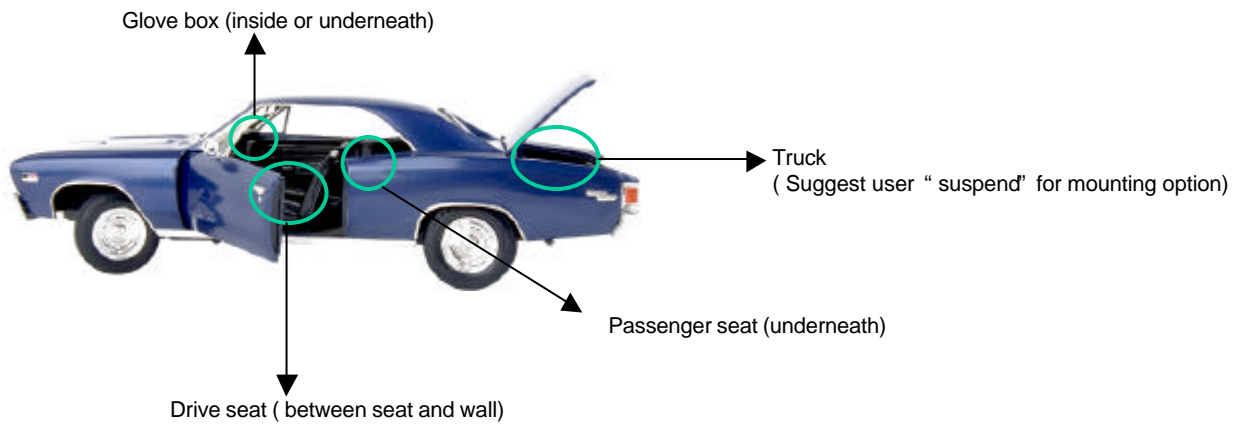

■ Show the wiring on the wiring harness that connects to the electrical system.

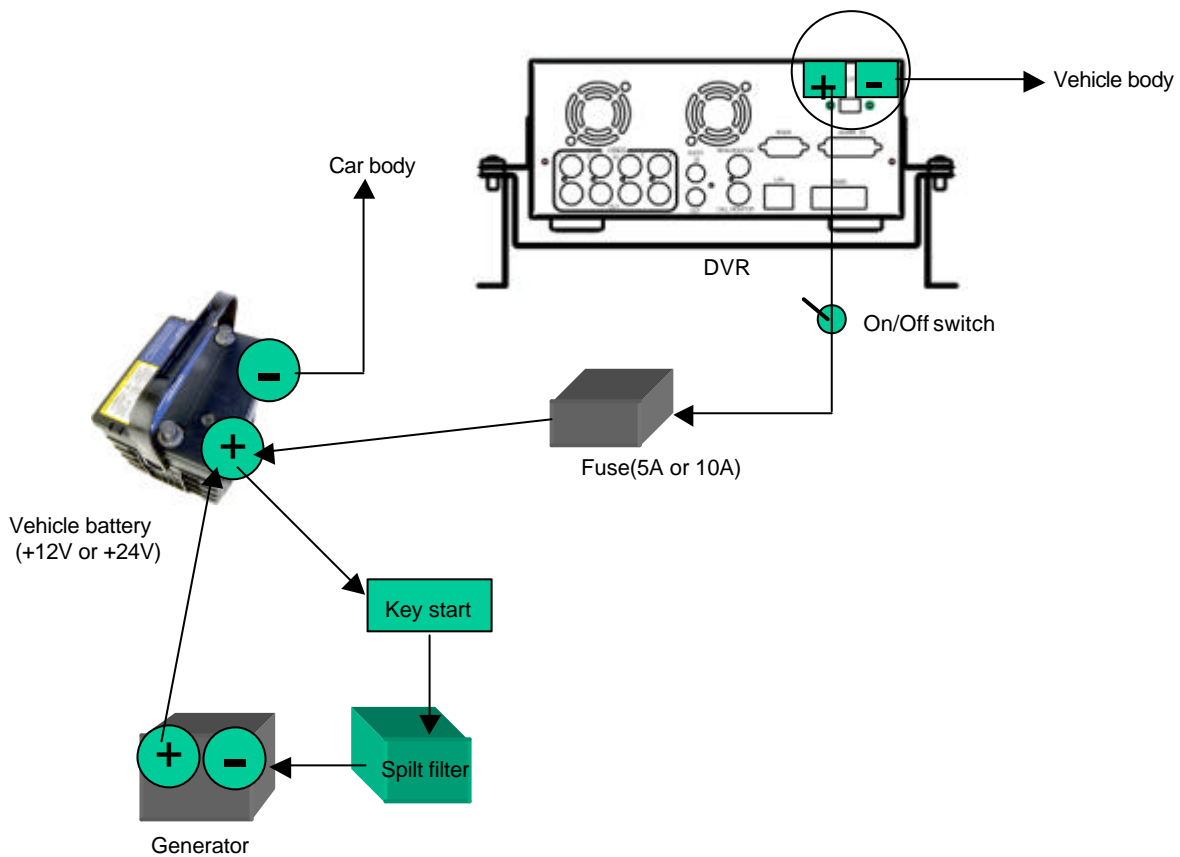

Quick Install Guide

■ Possible Installation Locations Inside the Automobile Vehicle: Truck

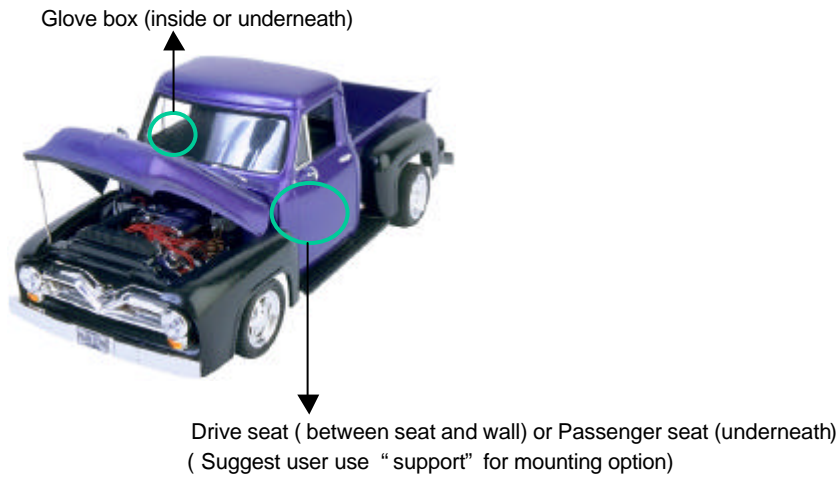

■ Show the wiring on the wiring harness that connects to the electrical system.

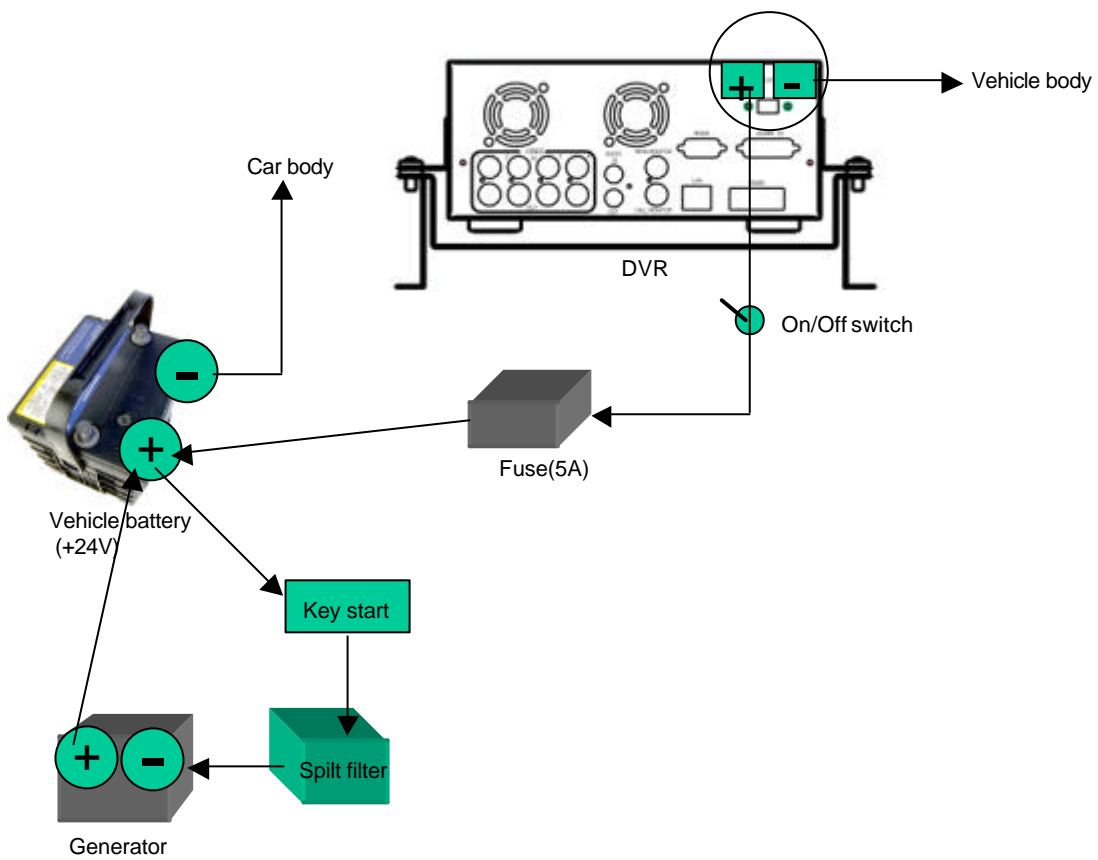

Quick Install Guide

■ Installing the Camera(s) and Monitor

The DVR is typically connected to one camera installed inside the car. Other camera(s) can also be installed in different location(for example, use the waterproof camera to the outside of vehicle). For installation procedure, refer to the guide that came with the camera(s) you purchased.

The Monitor power supply connect from the Automotive adapter(cigarette plug)
Monitor and cameras must be purchased separately.



■ Connect the Camera(s)

Connect the power connector from the camera(s) harness into the CAMERA POWER OUT jack on the back panel of the DVR.

Connect the primary camera(s) video connector to the CAMERA INPUT and the audio connector to the AUDIO INPUT In the back panel.

Adjust the camera(s). After the camera is installed, connect a monitor directly to the camera and observe the image. Make any adjustment necessary.

Quick Install Guide

■ Installing the Hard Drive

As following are the figure for the 3.5" and 2.5" HDD.

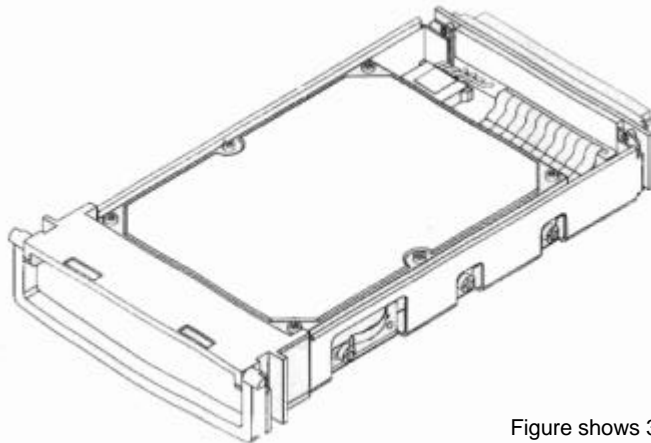

Figure shows 3.5" HDD

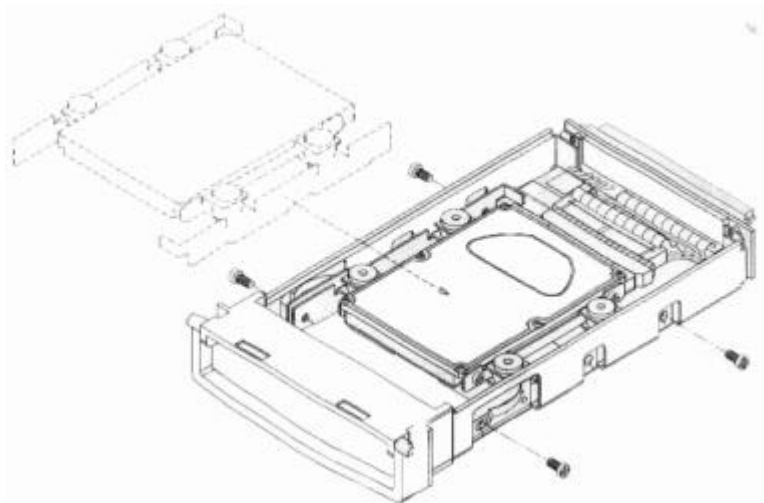

Figure shows 2.5" HDD

Table of Contents

1. Product Overview.....	1
1.1 Feature.....	1
1.2 Specifications.....	2
2. Front & Rear Panels.....	3
3. Back Panel Connections.....	5
4. System Connection.....	8
4.1 Before Installation.....	8
4.2 Basic Connection.....	9
5. Installation.....	10
6. Menu.....	11
6.1 Clock/Language Setup Menu.....	13
6.2 Title Setting Menu.....	14
6.3 Daylight Setting Menu.....	15
6.4 Timer Setting Menu.....	17
6.5 Normal Setting Menu.....	18
6.6 Alarm Record Setting Menu.....	19
6.7 Buzzer Setting Menu.....	24
6.8 Archive Setting Menu.....	25
6.9 Network Setting Menu.....	26
6.10 Sequence Setting Menu.....	27
6.11 RS232/485 Setting Menu.....	28
6.12 Motion Record Setting Menu.....	29
6.13 System Setting Menu.....	31
7. Recording.....	33
7.1 Instant Recording.....	33
7.2 Alarm Recording.....	34
8. Playback.....	36
8.1 Normal Playback.....	36
8.2 Search Playback.....	38
9. Copy.....	41
9.1 Still Image Copy.....	41
9.2 Copy to Movie File.....	42

Table of Contents

10. Interface Specifications	44
10.1 Transmission setting.....	44
10.2 Remote Control Protocol.....	45
11. Remote Controller	49
12. Appendix-A/Time Lapse Mode Recording Time	50
12.1 Recording with and 80 GB HDD.....	50
12.2 Recording with and 160 GB HDD.....	51
13.View from Internet/Intranet	52

Product Overview and Features

1. Product Overview

The EDSR400M is the first full-featured digital video recorder designed specifically for use in mobile applications. It features a superior image quality, easy to use VCR-styles controls and a rugged construction that will withstand high levels of vibration and humidity.

The EDSR400M is ideal for use in buses, cars, police cruisers, or any application requiring a rugged digital recorder. Video and audio can be recorded at speeds up to 60/50 fields per second (NTSC/PAL), and can be replayed instantly when the touch of a button. Highly efficient compression technology and superior resolution of recorded images make the EDSR400M stand out from the competition as the best choice in mobile surveillance.

1.1 Features

- ✍ Easy-to-use control panel with common VCR
- ✍ Shuttle/Jog dial for picture-by-picture or fast/slow viewing
- ✍ No tapes to manage, clean or replace
- ✍ Instant retrieval of stored video
- ✍ On-screen setup menu and system timer
- ✍ Ethernet TCP/IP connectivity for remote viewing and controlling
- ✍ Pre-Alarm and Post-Alarm process
- ✍ Built-in M-JPEG compression/decompression with configurable quality
- ✍ Programmed with various time-lapse speeds
- ✍ 2.5" or 3.5" IDE Type Hard Disks for storage with Hot-Swap tray
- ✍ RS232 and RS485 for Remote Control.
- ✍ Real-Time Live Display for all Cameras
- ✍ Variable recording speeds up to 60/50 IPS for NTSC/PAL
- ✍ Alarm-activated recording
- ✍ Data can be stored in CompactFlash
- ✍ Audio recording capabilities

Specifications

1.2 Specifications

Video Input	4 camera inputs (BNC),1Vp-p/75ohm
Video Output	1 BNC video out (1Vp-p/75 ohm) for Main Monitor 1 BNC video out (1Vp-p/75 ohm) for CALL Monitor 4 video out (1Vp-p/75ohm)for looping
Video Compression	M-JPEG
Recording Resolution	720x484 (NTSC); 720x576 (PAL)
CompactFlash Memory	Yes, Built-in Compact Flash card slot
Alarm Input	4 alarm inputs
Alarm Output	1 alarm output
Video Display	Full, PIP, Quad and 2x2 zoom for Live and Playback
Video Loss Detection	Yes
Ethernet	RJ45 connectors for network communications
Event Log	Yes
Hard Disk Storage	2.5" or 3.5" IDE type, Hot- swappable
Recording Mode	Continuous, Time-lapse recording, Schedule or Event Recording
Recording Rate	Up to 60/50 fields per second for NTSC/PAL
Playback Rate	Up to 60/50 fields per second for NTSC/PAL
Playback Search	By Date/Time or Event/Segment
Setup	On screen display setup
User Interface	Menu Driven
User Input Device	Front Panel Keypad
Timer	Built-in real time clock
Watch Dog Timer	Yes
RS-232	9-pin female connector
RS485	RJ45 Connector
Dimension	320.8mm (L) x 215mm (W) x 109.9mm (H)
Operating Temperature	0 ~+50
Power Consumption	60W
Power Source	DC12~24V
Operating Shock	8G,11ms(20 per five seconds maximum)
Operating Vibration	5~20 Hz, 0.037 inches(double amplitude), 5~500Hz 0.75G(0 to peak)

Front Panel Keypads

2. Front Panel Keypads

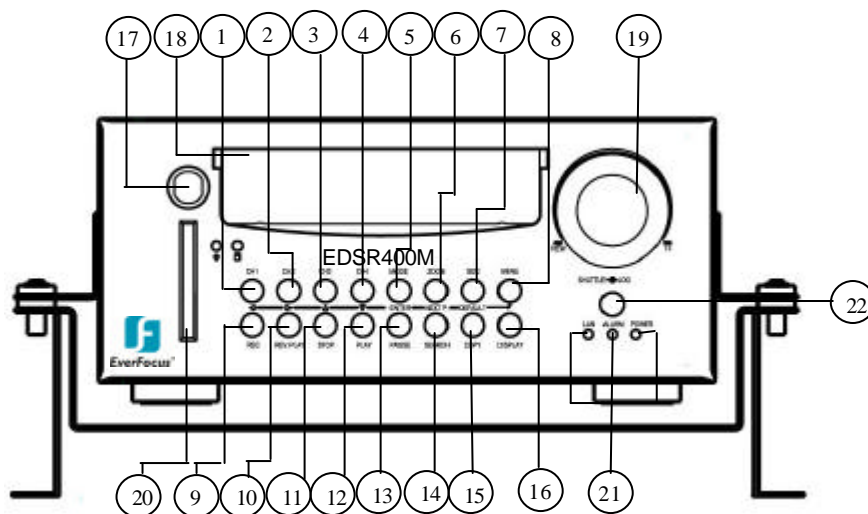

KEY

① ~ ④ **CH1 ~CH4:**

Press channel key (1~4) to display video image in the full screen format, the picture of the corresponding will fill the whole screen of the monitor display.

⑤ **MODE:** Switch PIP/Quad.

⑥ **ZOOM:** Press this key while viewing the full screen image to display a magnified resolution on the monitor.

⑦ **SEQ :** Press this key to enter the auto sequential switching mode.

⑧ **MENU:** Press this key to enter Setup menu.

⑨ **REC :** Press this key to start recording.

⑩ **REV. PLAY :** Reverse Play Back.

⑪ **STOP :** Press this key to stop recording and play back.

⑫ **PLAY:** Play Back.

⑬ **PAUSE:** Press this key to pause the playback picture.

⑭ **SEARCH:** Press this key to enter the Search Menu.

⑮ **COPY:** Under **PAUSE** or **PLAYBACK**, Press this key to start copy still picture or video stream into Compact Flash card.

- 16 **Display:** Press this key to switch ON/OFF.

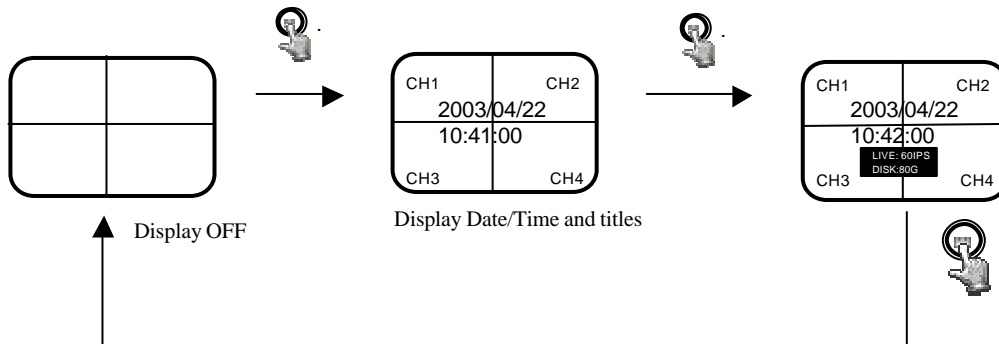

- 17 **HDD KEY:** Protect HDD without steal and Turn on HDD power

- 18 **Hard Disk Tray:** Hard Disk holder for HDD.

19 **Shuttle and Jog Dial**

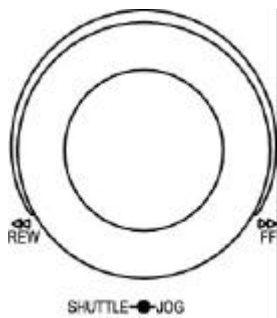

Shuttle : In Playback mode, turn the shuttle dial can fast forward/rewind the picture.
In Pause mode, turn the shuttle dial can slow forward/rewind the picture.

Jog Dial : In Pause mode, turn the jog dial can forward/rewind the Picture.
In Menu mode turn the jog dial to change setting Menu page.

- 20 **Compact Flash Card Slot:** Insert a Compact Flash Card.

- 21 **LEDs:** LEDs for system active power ,LAN and ALARM access.

- 22 **Remote Control:** IR Remote receiver

Back Panel Connections

MONITOR

- 3 **MAIN MONITOR** : This connector is used for the Main monitor display, A number of different display modes may be selected for viewing.
- 4 **CALL MONITOR** : This connector is used for the Call(secondary) monitor. This monitor can only display full screen.

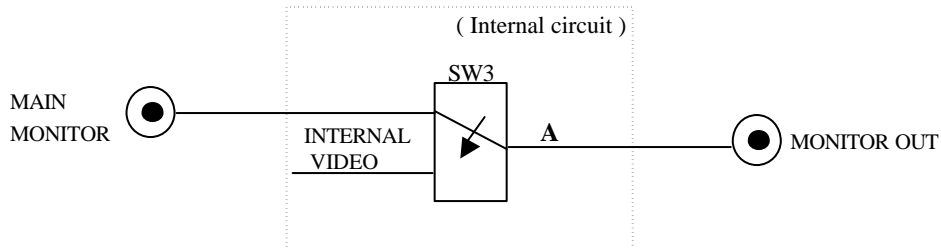

When the machine is in Menu, Search or Copy mode, the internal Video is switched to Monitor Out, so that the user can view full screen OSD. In other modes, the Video from multiplexer main monitor will be loop-through to the Monitor Out.

VIDEO IN /Output

- 5 **VIDEO IN (1~4)**: The BNC connectors of video input enables the system to receive the signals from each camera through the 75 ohm coaxial cables.

VIDEO OUT(1~4) : Connect the other devices with four cameras to the other devices.

Alarm Input/ Output

- 6 **Alarm Input**

ALM-INPUT : Normal Open or Normal Close type alarm sensor input.
The Alarm Input can be selected as Normal Open or Normal Close input in the setup menu. When an alarm occurs, alarm recording will automatically start.

ALM-OUTPUT : Normal Close Alarm output. In normal condition, this terminal is shorted to the terminal of ALM -COM. In alarm status, it is open between ALM-NC and ALM-COM terminals.

Back Panel Connections

3. Back Panel Connections

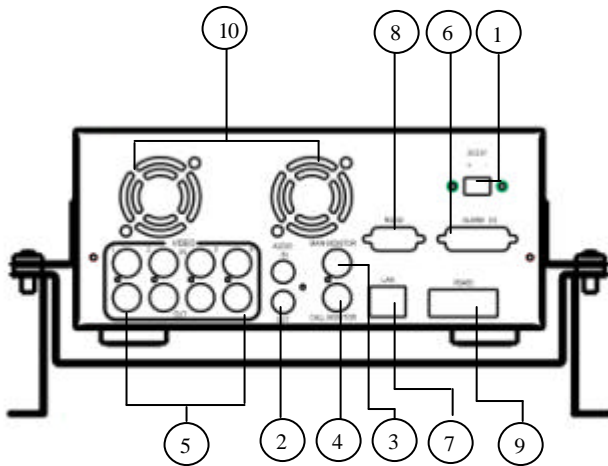

POWER

- 1 **Main Power plug:** Connect the DC12~24V power source to the power input terminal.

AUDIO

- 2 **Audio IN :** Audio input for recording.
- Audio OUT :** Audio output can be set to “ON” or “OFF” in Setup Menu.

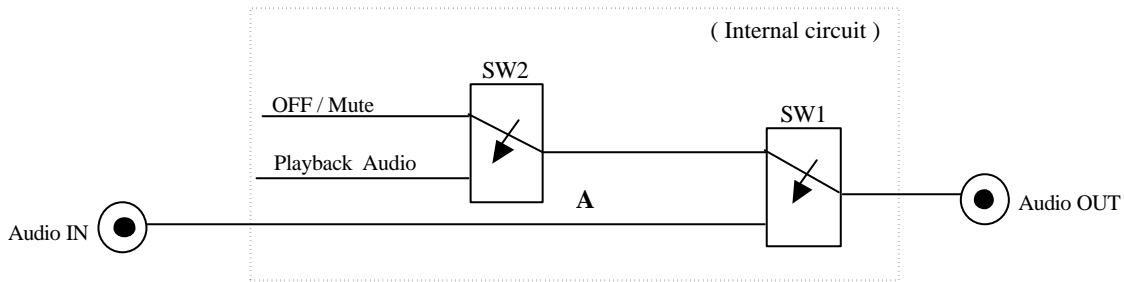

Operation of SW1 :

When in recording or standby mode, the out of SW1 is connected to Audio IN.
 When in playback mode the out of SW1 is connected to SW2 Audio.

Operation of SW2 :

When Playback Audio is enabled then the output of SW2 will be connected to Playback Audio.
 When Playback Audio is disabled then there is no audio output (MUTE).

When Audio Out is enabled and machine is in Recording or Standby mode, the Audio IN is loop-through to Audio Out connector.

When Audio Out is enabled and machine is in Playback mode then the Audio Out playback audio.

Back Panel Connections

LAN

- 7 **LAN Connector** : The RJ-45 LAN connector.

RS232

- 8 **RS232 connector** : Connect D-Sub 9 pins connector to RS232 ports for remote control

RS485

- 9 **RS485 connector** : RJ 45 Connector to Cascade multi Digital Video Recorder.

- 10 **FAN**: Cooling FAN.

System Connection

4. System Connection

The installations described below should be made by qualified service personnel or system installers.

4.1 Before Installation

Please refer to the following diagram for the system connections.

Note: Monitor and Camera must be purchased separately.

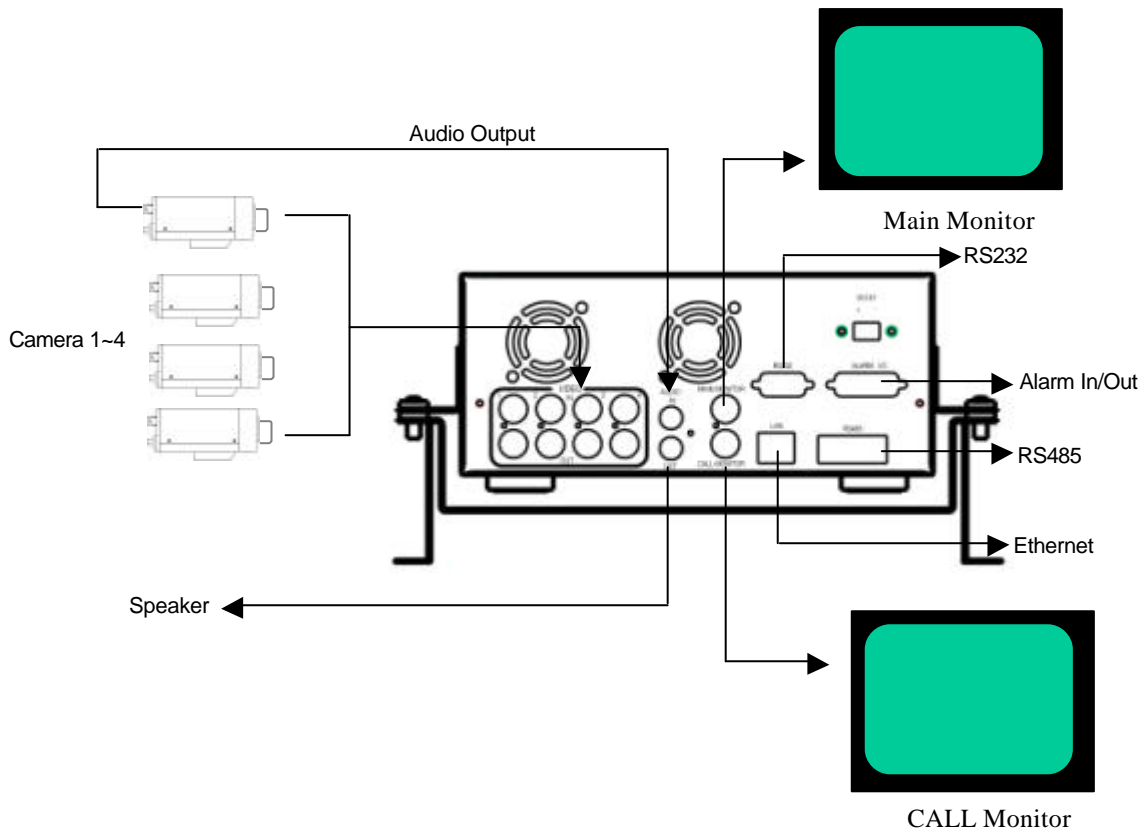

System Connection

4.2 Basic Connections

■ Power

Connect the power source or adapter into the power socket.

■ Cameras

Connect each camera video input connector to the video output from a camera or other composite video source. At least one camera must be connected before the system is running for the auto detection of video standard to take effect.

■ Audio In/Out:

The camera audio In/output is connected to the audio input terminal at the rear panel.

■ Speaker

Connect the speaker or other audio devices.

■ Ethernet

Digital Video Recorder is enabled control from the PC via Ethernet. Connect the LAN connector to a standard RJ45 connector Ethernet cable.

■ RS232/RS485

Digital Video Recorder is enabled control from the PC via RS232/RS485

Main/Call Monitor

- Connect the Main/Call monitor output connector to a Main/Call monitor. The Main/Call monitor displays selected live or recorded cameras in any available format.

INSTALLATION

5. Installation

(1) Insert a HDD (IDE) for Video Storage

Insert a HDD(IDE) for Video Storage
The HDD should be set as MASTER.
(Normally the default setting of HDD is Master)

Note: After hard disk case is inserted into the hard disk tray, be sure to turn the tray key in lock position.
Otherwise, HDD will not be detected.

(2) Connect cable for video/audio input and video/audio out,

The POWER LED lights if power is normal.

(3) Switch Power On

The detail connection is described in SYSTEM CONNECTION.

(4)



MENU

Press MENU key to enter SET UP MENU.

Once inside the main menu you will find there are
13 set up pages as below:

1. **CLOCK/LANGUAGE SETTING MENU**
2. **TITLE SETTING MENU**
3. **DAYLIGHT SAVING SETTING MENU**
4. **TIMER SETTING MENU**
5. **NORMAL RECORD SETTING MENU**
6. **ALARM RECORD SETTING MENU**
7. **BUZZER SETTING MENU**
8. **ARCHIVE SETTING MENU**
9. **NETWORK SETTING MENU**
10. **SEQUENCE SETTING MENU**
11. **RS232/RS485 SETTING**
12. **MOTION RECORD SETTING MENU**
13. **SYSTEM SETTING MENU**

(5)



Turn the Jog dial clockwise or counterclockwise to change set up page.

MENU

6. MENU FLOW



Turn the Jog dial clockwise or counterclockwise to change setting menu page.

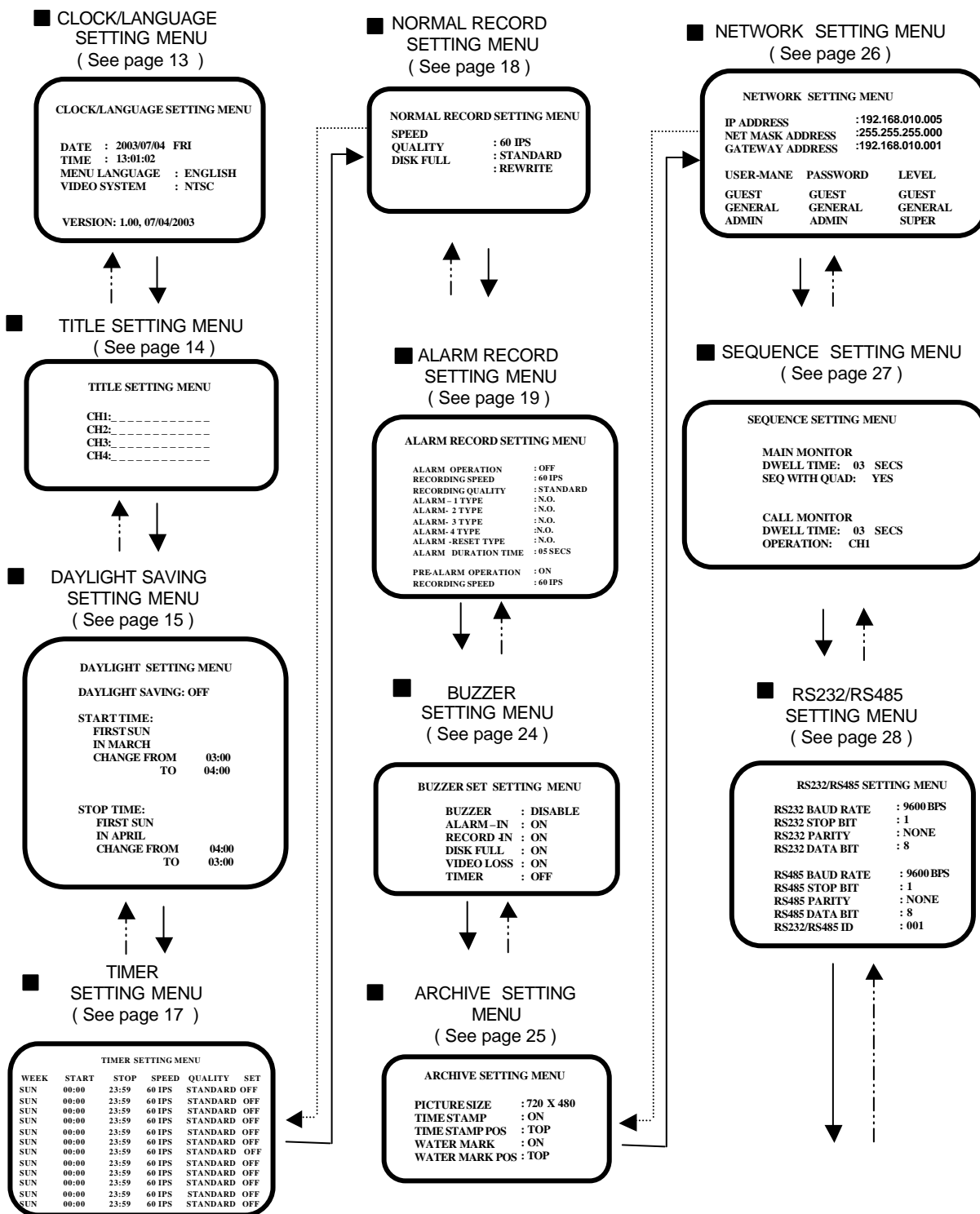

■ MOTION RECORD
SETTING MENU
(See page 29)

MOTION RECORD SETTING MENU		
RECORDING SPEED	:	60 IPS
RECORDING QUALITY	:	STANDARD
CH	OP	SEN
1	OFF	STANDARD
2	OFF	STANDARD
3	OFF	STANDARD
4	OFF	STANDARD
MANUAL EDIT: CHI		



■ SYSTEM SETTING MENU
(See page 31)

SYSTEM SETTING MENU		
PLAY WITH AUDIO	:	ON
DISK RENEW	:	NO
SYSTEM UPDATE	:	NO
LOAD DEFAULT	:	NO
PASSWORD INABLE	:	NO
PASSWORD	:	123456





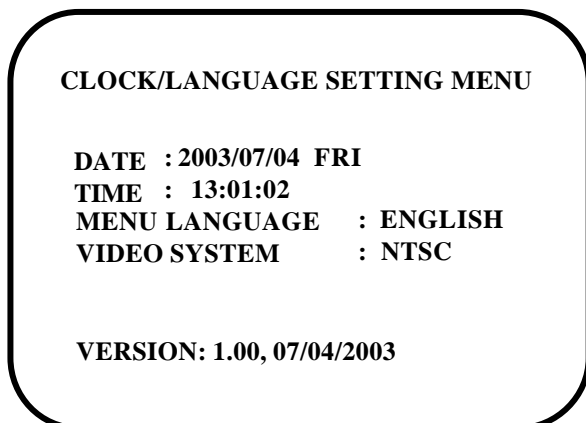

MENU



6.1 CLOCK/ LANGUAGE SETTING MENU



In **CLOCK/LANGUAGE SETTING MENU** , we define:

- (1) **DATE** : Current date
Year: 2000 ~ 2099 Month: 01~ 12 Date: 01~31 Week: Sunday~Saturday
- (2) **TIME** : Current time
Hour: 00 ~ 23 Minute : 00 ~ 59 Second: 00 ~ 59
- (3) **MENU LANGUAGE**:
ENGLISH
- (4) **VIDEO SYSTEM**:
Factory default setting depend on machine “NTSC” or “PAL” .
- (5) **VERSION**:
Current /Revision and Release Date.

    : Press  or  to move the cursor to the left or right.

: Press  or  to change the value.

MENU

6.2 TITLE SETTING MENU

TITLE SETTING MENU

CH1: _____

CH2: _____

CH3: _____

CH4: _____



In TITLE SETTING MENU , we define:



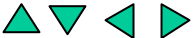

The title setting menu allows you to assign a title to each camera input. Titling with up to 9 characters is supported in each channel.

The available alphanumeric characters are:

0,1,2,3,4,5,6,7,8,9,
A,B,C,D,...X,Y,Z,
/() . - * & @ : ”

Default setting is shown above.

 : Press  or  to move the cursor to the left or right.

 or  : Press  or  to change the value.

MENU

6.3 DAYLIGHT SETTING MENU

DAYLIGHT SETTING MENU

DAYLIGHT SAVING: OFF

START TIME:
FIRST SUN
IN MARCH
CHANGE FROM 03:00
TO 04:00

STOP TIME:
FIRST SUN
IN MARCH
CHANGE FROM 04:00
TO 03:00

In **DAYLIGHT SETTING MENU** , we define:

- (1) **DAYLIGHT SAVING:**
Select “ON” or “OFF” while the daylight saving time function is enabled or not.

- (2) **START TIME:**

“**FIRST**” Use the arrows to set the present week

FIRST **SECOND** **THIRD** **FOURTH** **LAST**

“**SUN**”Use the arrow to set the present date

Sunday **Monday** **Tuesday** **Wednesday** **Thursday** **Friday** **Saturday**

“**IN MARCH**”Use the arrow to set the present month

January **February** **March** **April** **May** **June**
July **August** **September** **October** **November** **December**

“**CHANGE FROM**” “**TO**” Use the arrow to set the start time value.

(3) STOP TIME:

“**FIRST**” Use the arrows to set the present week

FIRST **SECOND** **THIRD** **FOURTH** **LAST**





“**SUN**” Use the arrow to set the present date

Sunday **Monday** **Tuesday** **Wednesday** **Thursday** **Friday** **Saturday**

“**IN MARCH**” Use the arrow to set the present month

January **February** **March** **April** **May** **June**
July **August** **September** **October** **November** **December**

“**CHANGE FROM**” “**TO**” Use the arrow to set the stop time value.

 : Press  or  to move the cursor to the left or right.
: Press  or  to change the value.

MENU

6.4 TIMER SETTING MENU

TIMER SETTING MENU					
WEEK	START	STOP	SPEED	QUALITY	SET
SUN	00:00	23:59	60 IPS	STANDARD	OFF
SUN	00:00	23:59	60 IPS	STANDARD	OFF
SUN	00:00	23:59	60 IPS	STANDARD	OFF
SUN	00:00	23:59	60 IPS	STANDARD	OFF
SUN	00:00	23:59	60 IPS	STANDARD	OFF
SUN	00:00	23:59	60 IPS	STANDARD	OFF
SUN	00:00	23:59	60 IPS	STANDARD	OFF
SUN	00:00	23:59	60 IPS	STANDARD	OFF
SUN	00:00	23:59	60 IPS	STANDARD	OFF
SUN	00:00	23:59	60 IPS	STANDARD	OFF
SUN	00:00	23:59	60 IPS	STANDARD	OFF
SUN	00:00	23:59	60 IPS	STANDARD	OFF

In TIMER SETTING MENU, we define

The monitored image can be recorded automatically by setting the start and end times in TIMER SET SETTING MENU, we can set the schedule to record for a whole week.

(1) WEEK:

This select the day for the timer Records on schedule.

(2) START:

This is used to enter the start time for timer recording.

(3) STOP:

This is used to enter the end time for timer recording.

(4) Speed :

Select recording speed.

(5) QUALITY:

Video recording quality setup, this item lets you set the quality of the video picture by selecting a compression rate.







There are six quality levels for recording



LOWER	:	15 KB
LOW	:	19 KB
BASIC	:	23 KB
STANDARD	:	27 KB
HIGH	:	31 KB
SUPERIOR	:	35 KB

(6)SET:

Set "ON" when using timer recording.

Set "OFF" when not using timer recording.

    : Press  or  to move the cursor to the left or right.

: Press  or  to change the value.

MENU

6.5 NORMAL RECORD SETTING MENU

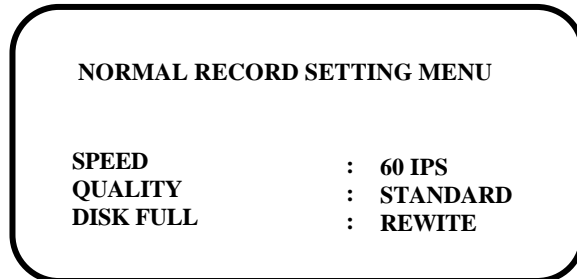

In NORMAL RECORDING MENU, we define

(1) **SPEED :** Recording Speed

The entry allows user to set the normal recording speed .

(2) **QUALITY:**

Video recording quality setup, this item lets you set the quality of the video picture by selecting a compression rate.



There are six quality levels for recording



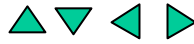

LOWER	:	15 KB
LOW	:	19 KB
BASIC	:	23 KB
STANDARD	:	27 KB
HIGH	:	31 KB
SUPERIOR	:	35 KB

(3) **DISK FULL:**

STOP : The unit will not replace over previously recorded data when disk full.

REWRITE : When the DVR is recording and in the “REWRITE” mode, the data on the hard drive will be constantly updated.

 : Press  or  to move the cursor to the left or right.

 or  : Press  or  to change the value.

MENU

6.6 ALARM RECORD SETTING MENU

ALARM RECORD SETTING MENU	
ALARM OPERATION	: OFF
RECORDING SPEED	: 60 IPS
RECORDING QUALITY	: STANDARD
ALARM -1 TYPE	: N.O.
ALARM -2 TYPE	: N.O.
ALARM -3 TYPE	: N.O.
ALARM- 4 TYPE	: N.O.
ALARM -RESET TYPE	: N.O.
ALARM DURATION TIME	: 05 SECS
PRE-ALARM OPERATION	: ON
RECORDING SPEED	: 60 IPS

In ALARM RECORDING MENU, we define

(1) ALARM OPERATION :

ON : Records when alarm occurs.

OFF : Do not record when alarm occurs.

(2) RECORDING SPEED : The recording speed in alarm duration.

(3) RECORDING QUALITY :

Select the Recording picture quality when alarm occurs.

LOWER	: 15 KB
LOW	: 19 KB
BASIC	: 23 KB
STANDARD	: 27 KB
HIGH	: 31 KB
SUPERIOR	: 35 KB

Note:The default setting is “STANDARD”. Higher video quality setting use more disk space.

MENU

- (4)~(5) ALARM -1 TYPE:
- ALARM -2 TYPE:
- ALARM -3 TYPE:
- ALARM-4 TYPE:

There are two alarm types for all cameras.
 One is normally open(N.O.) and the other setting is normally closed (N.C.).
 Default setting: Normally open(N.O.)

Note: Alarm Connectors (DB-15)

The alarm connector, figure 1, is used to provide one sensor alarm input for each camera input.
 For easy operation, an alarm extension board, figure 2, is provided to connect to the alarm connector.

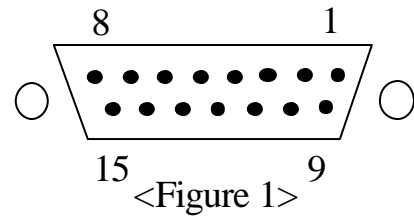

Each alarm input requires two wires, one wire connects to the desired alarm input pin, the second wire connects to the multiplexer ground. The alarm signal assignment is shown at the following table, table 1.

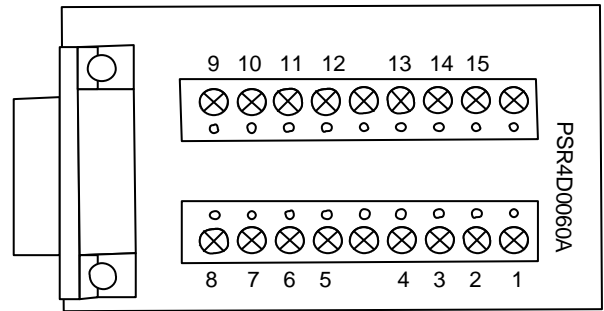

<Figure 2>

<Table 1>

PIN #	NAME	PIN #	NAME
1	GND	9	GPIN 2
2	ALMIN 1	10	DISK-FULL
3	ALMIN 2	11	GPOUT 1
4	ALMIN 3	12	GPOUT 2
5	ALMIN 4	13	ALM NC
6	ALMRST	14	ALM NO
7	REC IN	15	ALM COM
8	GND		

MENU

(a.) Alarm out

There are two ways to do the alarm out connection:

Normally open connection (use pin # 13 and # 14)

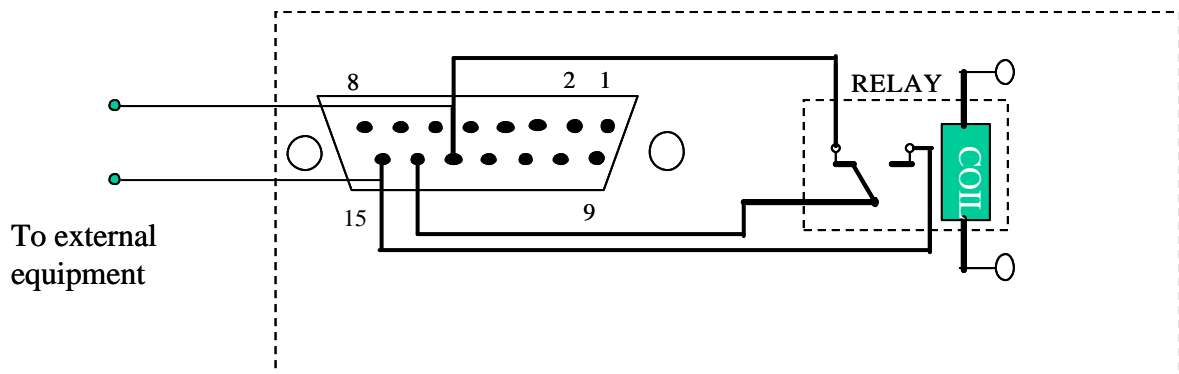

Normally Closed Connection (use pin # 13 and # 12)

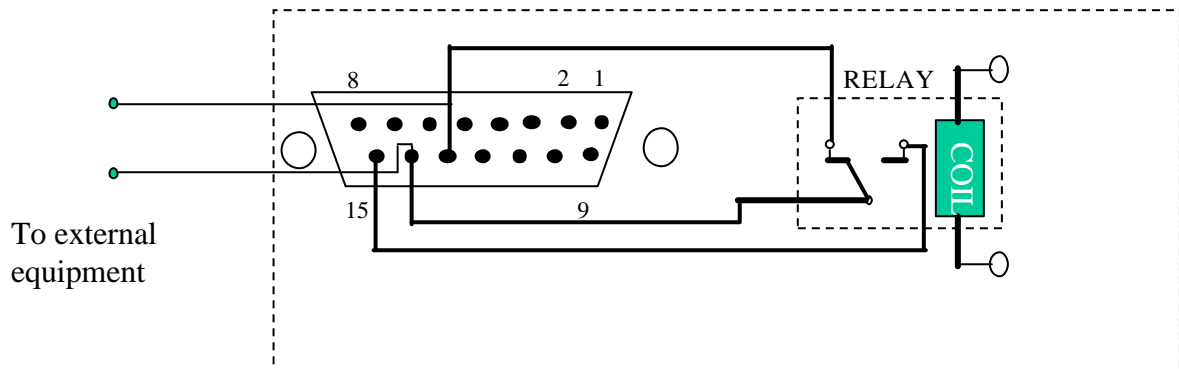

MENU

(b) Alarm in and alarm reset

There are 4 alarm sensors in for 4 channels and 1 alarm reset in, all these 5 alarm inputs can be set to Normally Open or Normally Closed by user.

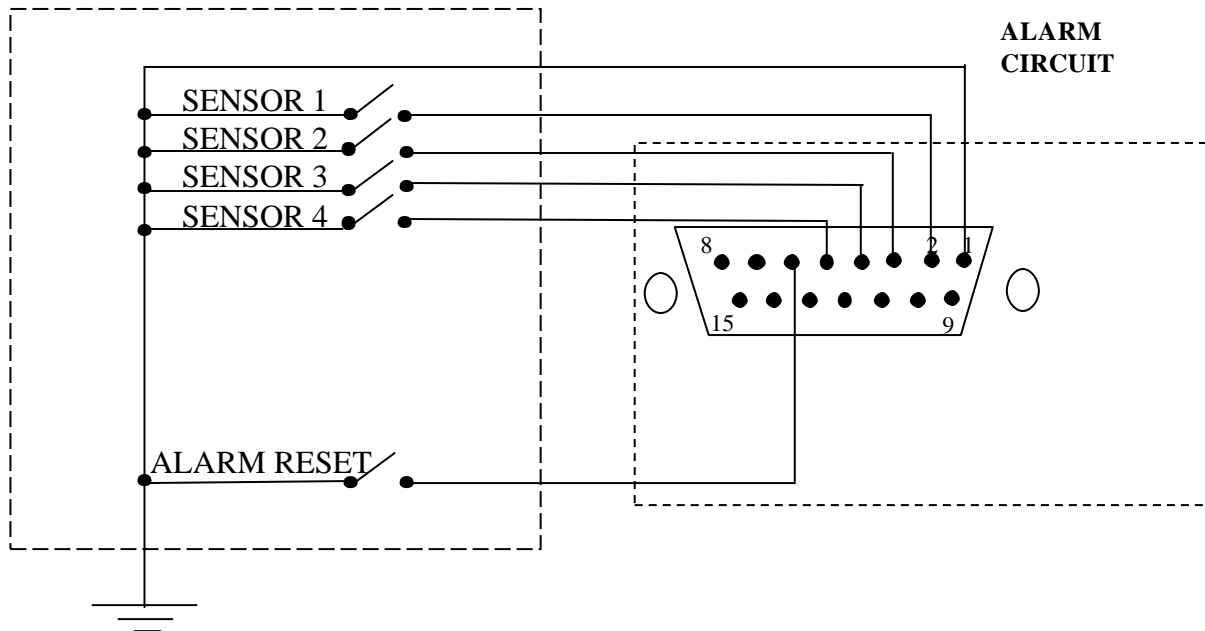

Alarm in

There are four alarm inputs. Please connect the alarm input in the same sequence as the cameras input BNC.

When any alarm signal comes in, the Digital Video Recorder will do the following:

1. Display Alarm Message
2. Turn on the buzzer if the buzzer setting is on.

The **ALARM in** can be selected as normally open input or normally closed input:

Normally Open : If the alarm input is selected as Normally Open input, then the (N.O.) input is opened normally, and shorted to the ground means an alarm happens.

Normally Close : If the alarm input is selected as Normally Close input, then the (N.C.) input is shored to the ground normally, and opened input means an alarm happens.

MENU

(7) ALARM - RESET TYPE:

N.O. : Normal Open

N.C. : Normal Close

(8) ALARM DURATION TIME :

When any sensor alarm connected to the device is activated, the device will immediately react an alarm and display the warning message. This entry is used to set the alarm duration from 1second to 99 second.



(9) PRE-ALARM OPERATION :





ON : Record the picture in pre -alarm recording speed in pre-alarm period.

OFF : No pre -alarm recording before alarm occurs.

(10) RECORDING SPEED :

The recording speed in pre-alarm period.

 : Press  or  to move the cursor to the left or right.

 or  : Press  or  to change the value.

Notice :

If the alarm occurs when it is in standby mode or in normal recording mode, the recording quality will be the same as the normal recording quality.

If the alarm occurs when it is in timer recording mode , the recording quality will be the same as the value set in timer recording quality.

MENU

6.7 BUZZER SETTING MENU

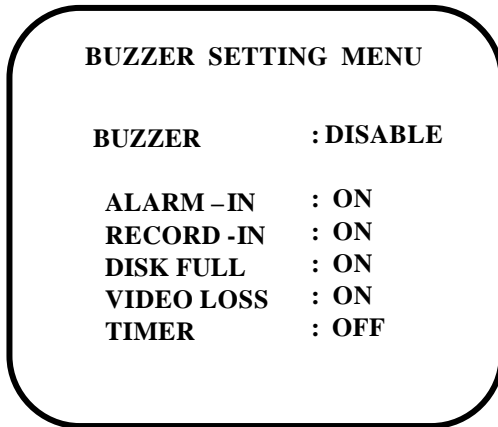

In **BUZZER SETTING MENU**, we SET the buzzer ON/OFF under the following conditions:

(1) BUZZER :

ENABLE: Select buzzer to be on..
DISABLE: Select buzzer to be off.

(2) ALARM -IN :

ON, the buzzer will sound when the alarm occurs.

(3) RECORD - IN:

ON, the buzzer will sound when Record-IN signal is applied on the Record-IN terminal.

(4) DISK FULL :



ON, the buzzer will sound when disk is near full 99.7%



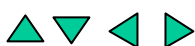

(5) VIDEO LOSS :

ON, the buzzer will sound when the video loses.

(6) TIMER :

ON, the buzzer will sound when timer record occurs.

 : Press  or  to move the cursor to the left or right.

 or  : Press  or  to change the value.

MENU

6.8 ARCHIVE SETTING MENU

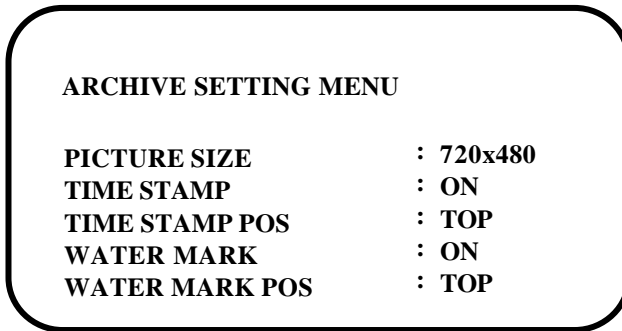

In the ARCHIVE SETTING MENU, we define

(1) PICTURE SIZE :

Selects picture size for copying image to CF card

Big size:720x480/720x576 for NTSC/PAL

Small size:352x240/352x288 for NTSC/PAL

(2) TIME STAMP :

ON: The time stamp will show on the picture when copying image to CF card.

OFF: The time stamp will not show on the picture when copying image to CF card.

(3) TIME STAMP POS:

BOTTOM: The time stamp will show on the bottom

TOP: The time stamp will show on the top

(4) WATER MARK:







ON: Shows a water mark on the picture when copying image to CF card.



OFF: This erases the water mark on the picture when copy image to CF card.

(5) WATER MARK POS:

BOTTOM: Water mark will show on the bottom

TOP: Water mark will show on the top

    : Press  or  to move the cursor to the left or right.

: Press  or  to change the value.

MENU

6.9 NETWORK SETTING MENU

NETWORK SETTING MENU		
IP ADDRESS	:	192.168.010.005
NET MASK ADDRESS	:	255.255.255.000
GATEWAY ADDRESS	:	192.168.010.001
USER-NAME	PASSWORD	LEVEL
GUEST	GUEST	GUEST
GENERAL	GENERAL	GENERAL
ADMIN	ADMIN	SUPER

In the NETWORK SETTING MENU, we define

- (1) **IP ADDRESS** : Assign an IP address for this unit, for example:192.168.010.005
- (2) **NET MASK ADDRESS**: Assign a subnet mask of the network for this unit, for example:255.255.255.000
- (3) **GATEWAY ADDRESS**: Assign a default gateway for this unit, for example:192.168.010.001

Note: when you setting above menu, screen will comes up as following normally:

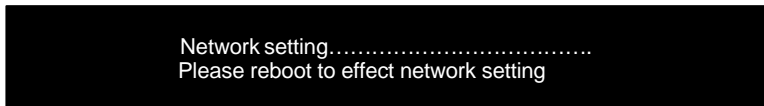

(4) **USER-NAME PASSWORD LEVEL**

The Login name and password are used to establish a network connection to the unit.





The Password Setup allows the administrator to set the new Login name and password with access level "Admin","General" or "Guest".

The system allows up to four users connected at same time with different access levels.

For "Admin" , can view live/playback video and control digital video recorder operation.

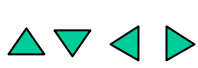
For "General", can view live and playback video.

For "Guest", can only view live.

-  : Press  or  to move the cursor to the left or right.
- : Press  or  to change the value.

MENU

6.10 SEQUENCE SETTING MENU

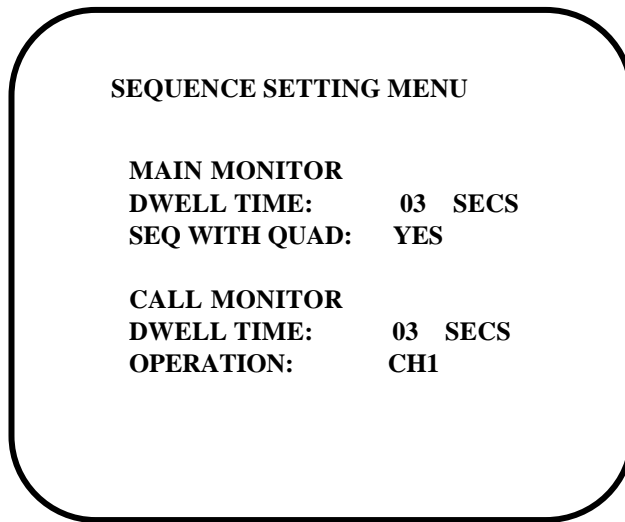

In the SEQUENCE SETTING MENU, we define

(1) MAIN MONITOR :

DWELL TIME : The main Dwell Time determines the rate at which the sequences cameras on the main monitor. The dwelling time for the auto sequencer can be set between (0-99) seconds.

SEQ WITH QUAD:

ON: The quad screen display is under the auto sequential switching mode.



OFF: The quad screen display is not under the auto sequential switching mode.



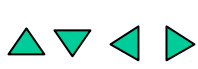

(2) CALL MONITOR :

DWELL TIME : The main dwell time determines the rate at which the sequences cameras on the call monitor. The dwelling time for the auto sequencer can be set between (0-99) seconds.

OPERATION: This entry allow the user choose the channel form CH1 to CH 4 for sequence screen.

Note: Call monitor will display automatically when alarm working.

 : Press  or  to move the cursor to the left or right.

 or  : Press  or  to change the value.

MENU

6.11 RS232/RS485 SETTING MENU

RS232/RS485 SETTING MENU

RS232 BAUD RATE : 9600 BPS
RS232 STOP BIT : 1
RS232 PARITY : NONE
RS232 DATA BIT : 8

RS485 BAUD RATE : 9600 BPS
RS485 STOP BIT : 1
RS485 PARITY : NONE
RS485 DATA BIT : 8
RS232/RS485 ID : 001

In the RS232/RS485 SETTING MENU, we define

(1) **RS232 BAUD RATE:** There are 6 different speeds that can be used to transmit instruction or information through the RS232 port on the device, 1200 baud,2400 baud,4800 baud,9600 baud, 19200 baud,and 3840 baud. The default setting from the factory is 9600 baud.

(2) **RS232 STOP BIT:** Select stop bit: 1 or 2

(3) **RS232 PARITY:** Select parity lever: NONE/ODE/EVEN

(4) **RS485 DATA BIT:** Select data bit : 8 or 7

(5) **RS485 BAUD RATE:** There are 6 different speeds that can be used to transmit instruction or information through the RS485 port on the device, 1200 baud,2400 baud,4800 baud,9600 baud, 19200 baud,and 3840 baud.

(6) **RS485 STOP BIT:** Select stop bit: 1 or 2







(7) **RS485 PARITY:**Select parity lever: NONE/ODE/EVEN



(8) **RS485 DATA BIT:** Select data bit : 8 or 7

(9) **RS232/RS485 ID:**

This entry is used to assign each device with its own ID code, when more than on unit is used in one system through RS232/RS485.

There are two ID code for the Digital video recorder : 001 or 002

    : Press  or  to move the cursor to the left or right.

: Press  or  to change the value.

MENU

6.12 MOTION RECORD SETTING MENU

MOTION RECORD SETTING MENU

RECORDING SPEED : 60 IPS
RECORDING QUALITY : STANDARD

CH	OP	SEN
1	OFF	STANDARD
2	OFF	STANDARD
3	OFF	STANDARD
4	OFF	STANDARD

MANUAL EDIT: CH1

In the MOTION RECORD SETTING MENU, we define

(1) RECORDING SPEED:

Select MOTION RECORDING SPEEED

(2) RECORDING QUALITY:

Select the Motion recording picture quality when motion occurs.

LOWER	:	15KB
LOW	:	19KB
BASIC	:	23KB
STANDARD	:	27KB
HIGH	:	31KB
SUPERIOR	:	35KB

(3) CH: (CHANNEL)

Select camera form CH1 to CH4.

(4) OP: (OPTION)

ON: The device will response record when motion occurs.

OFF: The device will not response record when motion occurs

(5) SEN:(SENSITIVITY)

This entry allows user to set the Motion recording picture's quality for each camera when motion occurs. There are four different sensitivity that can be used to set the picture's quality, High, Standard, Basic, and Low. The default setting is "STANDARD".

(6) MANUAL EDIT:

Select desired channels (CH1~CH4) to set up the Motion Recording separately.

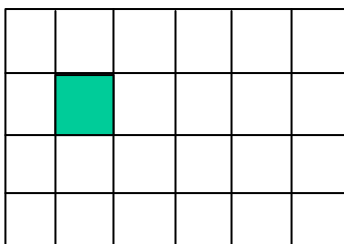



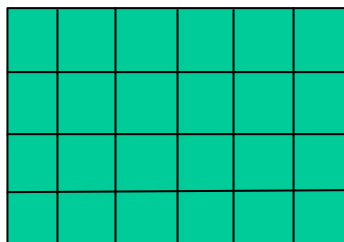

Use the arrows to move the square for motion recording.

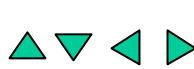

When displaying in full screen format, press "Enter" button once. The device will proceed auto toggle for all squares on the screen.

Press the "SEQ" button once to display the full screen or not.

 : Press  or  to move the cursor to the left or right.
: Press  or  to change the value.

MENU

6.13 SYSTEM SETTING MENU

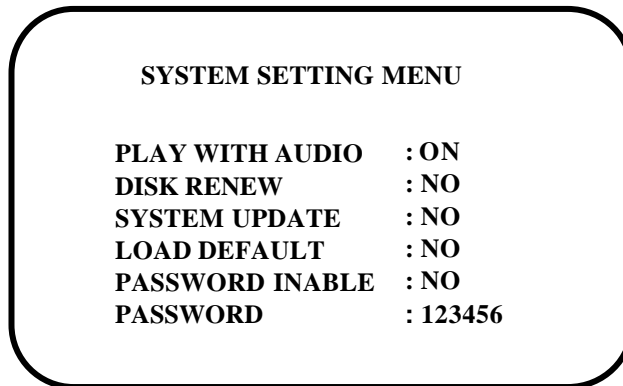

In the SYSTEM SETTING MENU, we define

(1) PLAY WITH AUDIO:

ON/OFF: Play back with or without audio.

(2) DISK RENEW:

NO : Activates the Renew HDD option.

YES : The double check dialog will appear on the screen.

(3) SYSTEM UPDATE :

YES/NO : Updates the system.

YES : Copy the update files into Compact Flash card ON PC and insert the Compact Flash card into the slot, and then press ENTER key to update system.

Notice: After the system is updated successfully, be sure reboot the system.

MENU

(4) LOAD DEFAULT :

YES/NO : Load the Load System.

YES : The double check dialog will appear on the screen.

(5) PASSWORD INABLE:

Password is used to prevent unauthorized personnel to change any setup of the device.
Set " NO" to release password function, set " YES" to enable password function.

(6) PASSWORD:

With up to 6 characters is supported in the digital video recorder.
The available alphanumeric characters are:

0,1,2,3,4,5,6,7,8,9,
A,B,C,.....X,Y,Z
/ () . - * & @ : "



The factory default setting for password is disable.

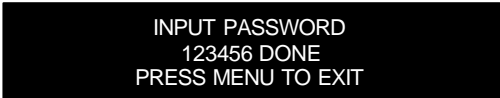

Note: Security Lock Setting:

When the image recording, press " STOP" to enter the password.
The screen will show as below:

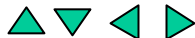

INPUT PASSWORD
123456 DONE
PRESS MENU TO EXIT

 : Press  or  to move the cursor to the left or right.

: Press  or  to change the value.

Recording

7.1 INSTANT RECORDING

- Press Record key to start the recording immediately.



REC

When pressed, the pictures being monitored will be recorded in the HDD.

- The recording rate and recording quality are set in the Record Set menu
- “RECORD” appears in the operating display

Video out

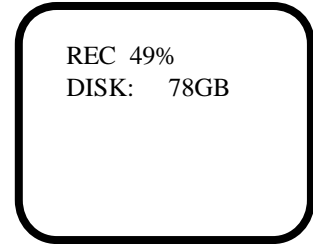

STOP

Press Stop key to stop recording.

- Stop key can be activated only in recording mode.

• When the HDD is full, the machine will Stop recording automatically or Overwrite from the beginning of the HDD. It depends on the setting in HDD setting

Recording

7.2 ALARM RECORDING

During user setting “ON” in the ALARM OPERATION, The image will automatically record when alarm occurs , and will automatically stops recording at the end of the alarm duration period.

As example, we set ALARM RECORDING SPEED on 60 IPS, and the ALARM DURATION TIME is 5 seconds, the screen will show as below,

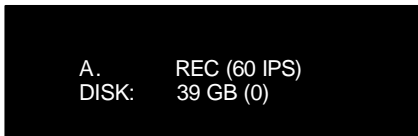

Instant recording and timer recording will stop when an alarm occurs.



MENU

Press MENU key and turn the jog dial to select the ALARM RECORDING SETTING MENU.

■ RECORDING OPERATION:

ON: Enables alarm recording,
OFF :Disables alarm recording.

■ RECORDING SPEED:

Set the recording speed when alarm occurs.

■ RECORDING QUALITY:

In alarm duration, the recording quality can be set which is different from instant or timer recording.

■ ALARM – 1 TYPE

ALARM – 2 TYPE

ALARM – 3 TYPE

ALARM – 4 TYPE

Select the separate type of ALARM 1 to ALARM 4 TYPE input to be Normal Close (N.C.) or Normal Open (N.O.)

■ **ALARM – RESET TYPE:**

Select the type of alarm-reset input to be Normal Close (N.C.) or Normal Open (N.O.)

■ **ALARM DURATION TIME:**

Alarm duration from 01 seconds to 90 seconds.

■ **PRE-ALARM OPERATION:**

ON: Enables pre-alarm recording,

OFF: Disables pre-alarm recording.

■ **RECORDING SPEED:**

Set the recoding speed in pre-alarm duration.

Notice:

The recording quality in pre-alarm duration is the same as recording quality before alarm occurs. If the recorder is not recording before alarm occurs, the recording quality in pre-alarm duration will be the same as instant recording quality.

Playing Back

8.1 NORMAL PLAYBACK

(1) Playback



PLAY

Press the **PLAY** key to start playing back the stored image/audio from the last **SEGMENT**.



REV.PLAY

Press the **REV.PLAY** key to start reverse playing back the stored image/audio from the last segment.

(2) STOP



STOP

Press the **STOP** key to stop playing back.

(3) Fast Forward/Reverse Playback



PLAY

Press the **PLAY** key to start playing back.

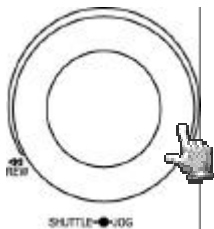

Turn the shuttle dial clockwise and fast forward playback starts.
The speed will be shown on the **SCREEN** at the right upper corner of the screen.

>> 2, 4, 6, 8, 16, 32, 600X

Turn the shuttle dial counterclockwise and fast reverse playback starts.

The speed will be shown on the **SCREEN**.

<< 2, 4, 6, 8, 16, 32, 600X

Playing Back

(4) Slow Forward/Reverse Playback



PAUSE

During Playback, press PAUSE key to freeze the playing back picture.

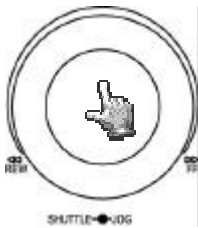

Turn the shuttle clockwise and slow forward playback starts.
The speed will show on the SCREEN at the corner of the screen.
>> 1/2, 1/4, 1/6, 1/8, 1/10, 1/16, 1/32

Turn the shuttle counterclockwise and slow reverse playback starts.
The speed will show on the SCREEN at the corner of the screen.
<< 1/2, 1/4, 1/6, 1/8, 1/10, 1/16, 1/32

(5) Field advance Forward/Reverse



PAUSE

Press PAUSE key to freeze the picture.

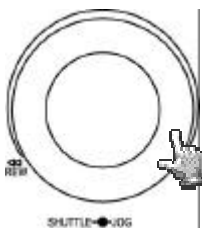

Turn the jog dial clockwise to advance the still image Field by Field.

Turn the job dial counterclockwise to rewind the still image Field by Field.

The Field feed speed will increase if the jog dial is turned quickly.

Playing Back

8.2 SEARCH PLAYBACK

(1) Segment Search Playback



SEARCH

Press the SEARCH key to enter the Search menu.

SEARCH MENU



BY SEGMENT LIST
BY ALARM LIST
BY DATA TIME

Press the   keys to move the cursor to BY SEGMENT LIST and press ENTER key to select file search.

SEGMENT SEARCH

0001	A1	2002/04/24	19/03/29
0002	T	2002/04/25	12/30/30
0003	T	2002/05/20	12/00/00

A1 : ALARM RECORD by ALARM-IN
T : TIMER RECORD

Press the   keys to move the cursor to the segment you want to playback. Press Enter to select the segment.
When the selection list is full, turn the jog dial clockwise to select next page list for search other list.
After the starting time is confirmed, press Enter to start playing back.

Playing Back

(2) Alarm Search Playback





SEARCH

Press SEARCH key to enter the Search menu.

SEARCH MENU



BY SEGMENT LIST
BY ALARM LIST
BY DATE TIME

Press the   keys to move the cursor to BY ALARM LIST and press ENTER key to select alarm search.

ALARM SEARCH

1	A	2002/04/24	19/03/29
2	T	2002/04/25	12/30/30
3	T	2002/05/20	12/00/00

A1 :ALARM RECORD by ALARM-IN
T : TIMER RECORD

Press the   keys to move the cursor to select the alarm image to be played back. When the selection list is full, turn the jog dial clockwise to select next page for search other list.
The alarm image will be played back from the pre-alarm period and stop at the end of alarm duration.



Playing Back

(3) Date/Time Search Playback







Press SEARCH key to enter the Search menu.

SEARCH MENU
BY SEGMENT LIST
BY ALARM LIST
BY DATE/TIME

Press the   keys to move the cursor to BY DATE/TIME and press ENTER key to select file search.

DATE/TIME SEARCH
YEAR/MM/DD HH:MM:SS
2005 01 01 21 33 26 SEARCH

Press the   keys to move the cursor.

Press the   keys to increase/decrease the data.
Press Enter and the playback starts from the date/time set in the menu.

Notice: If there is no image stored in the date/time specified then the machine will start playing back from the nearest set time automatically.

COPY

9.2 COPY TO MOVIE FILE



PLAY

Press the **PLAY** key to start playing back.



COPY

Press **COPY** key and then the copy menu appears.

The full screen will show up from Quad display.

Digital Video Recorder allow the user to select the camera for copy image to movie file. The camera title will displaying at the top of the screen

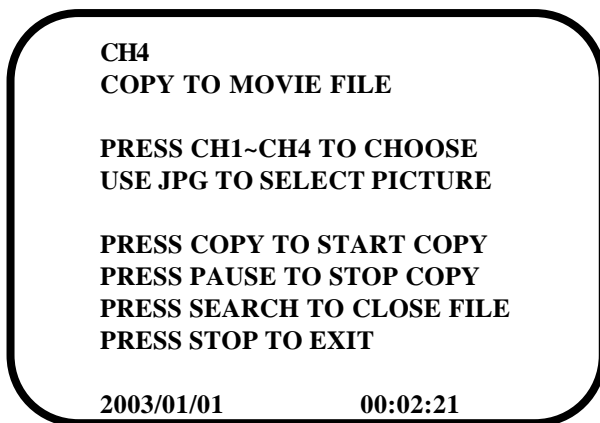

COPY

While displayed as your desired image of choice,
Press “**COPY**” button once to start copy image.

COPY

9. COPY

Insert a Compact Flash card into the Compact Flash slot on the front panel.

When inserting the Compact Flash card, make sure that the direction of insertion is correct.

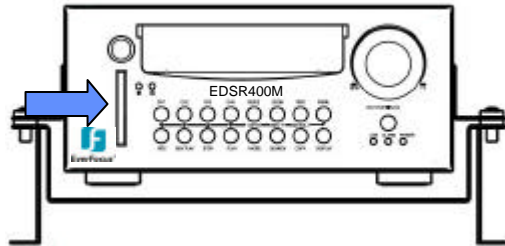

9.1 STILL IMAGE COPY



PAUSE

**Press the PLAY key to start playing back.
Press the PAUSE key to pause playback.**

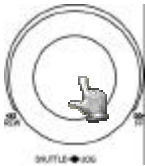

Turn the jog dial clockwise to choose your desired image.



COPY

**While displayed as your desired image of choice ,
press the COPY key. The “ Copying ...” will be shown on the screen during
the process. The “ Done” will be shown on the screen after file copied**

Notice: Copied images are stored as a single picture.
Copied files are saved as .JPG file.

COPY



PAUSE

Press “PAUSE” button once to stop copy image.



SEARCH

Press “SEARCH” button once to close file.



STOP

Press “STOP” button once to Exit.

Notice: Copied images are stored as a movie picture.
Copied files are saved as .MOV file.
Use QuickTime to play the retrieved .MOV files.
You may download QuickTime at www.apple.com.
The playback version for QuickTime is free.

Interface Specifications

RS232

This Digital Video Recorder may be controlled by a computer or a terminal via the standard D-SUB 9-pin RS-232 connector.

■ **D-SUB 9-pin connector specifications**

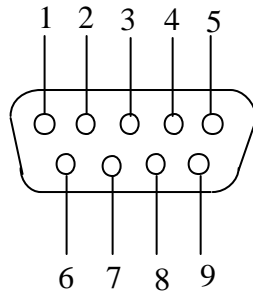

■ **The pin assignment of the 9-pin D-SUB connector**

Digital Video Recorder			HOST	
PIN #	NAME		PIN #	NAME
1	NOT CONNECTED		1	NOT CONNECTED
2	TXD	→	2	RXD
3	RXD	←	3	TXD
4	NOT CONNECTED		4	NOT CONNECTED
5	GROUND	—	5	GROUND
6	NOT CONNECTED		6	NOT CONNECTED
7	NOT CONNECTED		7	NOT CONNECTED
8	NOT CONNECTED		8	NOT CONNECTED
9	NOT CONNECTED		9	NOT CONNECTED

10.1 Transmission setting

There are 6 different speeds that can be used to transmit instruction or information through the RS232/RS485 port on the device, 1200 baud,2400 baud,4800 baud,9600 baud, 19200 baud,and 3840 baud.

The default setting from the factory is 9600 baud.

Please refer to Chart 6.11 (page28) for details.

Interface Specifications

10.2 Remote Control Protocol

A computer or a terminal can be used to control the unit by sending the packet as following.

=====
Digital video recorder RS 485/232 Control Code Protocol
=====

1-1. Sample control code packets

Example1 : A packet that send "REC" key to Digital Video Recorder (ID=5)

0x85	(length)
0x00	(Receiver ID high byte)
0x05	(Receiver ID low byte)
0x4B	(OPcode = key)
0x08	(DATA1 = "Rec" keycode)
0x5D	(checksum)

Example2 : A packet that send "PAUSE" key to Digital Video Recorder (ID=4999)

0x85	(length)
0x27	(Receiver ID high byte)
0x07	(Receiver ID low byte)
0x4B	(OPcode = key)
0x0C	(DATA1 = "Pause" keycode)
0x0A	(checksum)

Example3 : A packet that send "PLAY" key to all Digital Video Recorder (broadcast)

0x85	(length)
0x7f	(Receiver ID high byte)
0x7f	(Receiver ID low byte)
0x4B	(OPcode = key)
0x0B	(DATA1 = "Play" keycode)
0x59	(checksum)

2-1. The format of message packet is as follows:

Length Byte (Prefix: 0x86, 0x87, or 0x88)
Receiver ID high byte
Receiver ID low byte
Opcode Byte
Data Byte1
Data Byte2
Data Byte3
.
.
Checksum Byte

2-2. Length Byte

This Length Byte is also a prefix. Bit7 must be 1.

EX: 0x87 ==> this packets has 7 bytes length. (not included Length byte itself)

2-3. Receiver ID

1). Individual receiver ID

Decimal	14bit binary value	Hbyte	byte	Receiver ID (Digital Video Recorder)
0	0000000 0000000	00	00	ID = 0
1	0000000 0000001	00	01	ID = 1
2	0000000 0000010	00	02	ID = 2
....				
126	0000000 1111110	00	7e	ID = 126
127	0000000 1111111	00	7f	ID = 127
128	0000001 0000000	01	00	ID = 128
129	0000001 0000001	01	01	ID = 129
255	0000001 1111111	01	7f	ID = 255
256	0000010 0000000	02	00	ID = 256
....				
511	0000011 1111111	03	7f	ID = 511
....				
16382	1111111 1111110	7f	7e	ID = 16382

2). Broadcast ID

Decimal	14bit binary value	Hbyte	Lbyte	Receiver ID (Digital Video Recorder)
16383	1111111 1111111	7f	7f	all Digital Video Recorder connect to RS485

2-4. Opcode Byte & Data bytes

2-4-1. OPcode

Opcode	Data1	Function
0x4B	Keycode	A remote key pressed

2-4-1. A remote key pressed (OPcode=0x4B)

Data1	Key
0x00	key 'CH1'
0x01	key 'CH2'
0x02	key 'CH3'
0x03	key 'CH4'
0x04	key 'MODE'
0x05	key 'ZOOM'
0x06	key 'SEQ'
0x07	key 'MENU'
0x08	key 'REC'
0x09	key 'REV.PLAY'
0x0A	key 'STOP'
0x0B	key 'PLAY'
0x0C	key 'PAUSE'
0x0D	key 'SEARCH'
0x0E	key 'COPY'
0x0F	key 'DISPALY'
0x10	key 'SHUTTLE << x2"
0x11	key 'SHUTTLE << x4"
0x12	key 'SHUTTLE << x6"
0x13	key 'SHUTTLE << x8"
0x14	key 'SHUTTLE << x16"
0x15	key 'SHUTTLE << x32"
0x16	key 'SHUTTLE << x600"
0x17	key 'SHUTTLE >> x2"
0x18	key 'SHUTTLE >> x4"
0x19	key 'SHUTTLE >> x6"
0x1a	key 'SHUTTLE >> x8"
0x1b	key 'SHUTTLE >> x16"
0x1c	key 'SHUTTLE >> x32"
0x1d	key 'SHUTTLE >> x600"
0x1e	key 'JOG<'
0x1f	key 'JOG>'

2-5. Checksum Byte

Checksum is computed as the sum of all previous byte (including the length byte), then mask with 0x7f.

Remote Controller

11. Remote Controller

(Optional)

- The remote controller is an accessory to enhance the handy operations of digital video recorder (Figure 1). You can do all the settings and operations by the remote controller. The effective distance is up to 10 meters without any obstacles. The keypad functions are as same as the front panel of the digital video recorder .

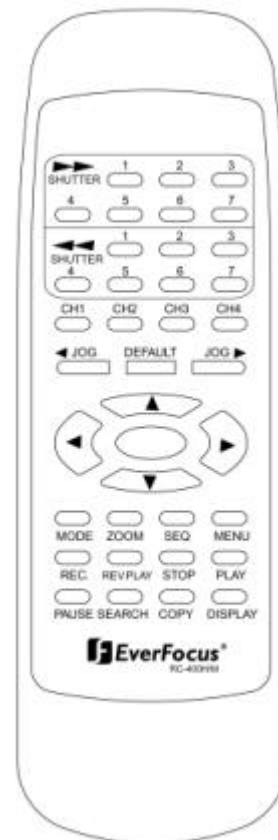

Figure 1

Appendix-A

12. APPENDIX- A/Time Lapse Mode Recording Time

12.1 When Recording with an 80-GB HDD

(Estimated with typical image-low noise level)

Lower : 15 kB
 Low : 19 kB
 Basic : 23 kB
 Standard : 27 kB
 High : 31 kB
 Superior : 35 kB

NTSC							
		system storage(GB):					
		80					
Recording Speed (IPS)	PICTURE QUALITY (KB)						
	LOWER	LOW	BASIC	STANDARD	HIGH	SUPERIOR	
	15	19	23	27	31	35	
60	24.7	19.5	16.1	13.7	11.9	10.6	
30	49.4	39	32.2	27.4	23.9	21.2	
20	74.1	58.5	48.3	41.2	35.8	31.7	
15	98.8	78	64.4	54.9	47.8	42.3	
10	148.1	117	96.6	82.3	71.7	63.5	
5	296.3	233.9	193.2	164.6	143.4	127	
1	1481.5	1169.6	966.2	823	716.8	634.9	
0.5	2963	2339.2	1932.4	1646.1	1433.7	1269.8	
0.3	4938.3	3898.6	3220.6	2743.5	2389.5	2116.4	
0.2	7407.4	5848	4830.9	4115.2	3584.2	3174.6	
PAL							
Recording Speed (IPS)	PICTURE QUALITY (KB)						
	LOWER	LOW	BASIC	STANDARD	HIGH	SUPERIOR	
	15	19	23	27	31	35	
50	29.6	23.4	19.3	16.5	14.3	12.7	
25	59.3	46.8	38.6	32.9	28.7	25.4	
10	148.1	117	96.6	82.3	71.7	63.5	
5	296.3	233.9	193.2	164.6	143.4	127	
2	740.7	584.8	483.1	411.5	358.4	317.5	
1	1481.5	1169.6	966.2	823	716.8	634.9	
0.5	2963	2339.2	1932.4	1646.1	1433.7	1269.8	
0.4	3703.7	2924	2415.5	2057.6	1792.1	1587.3	
0.2	7407.4	5848	4830.9	4115.2	3584.2	3174.6	
0.1	14814.8	11695.9	9661.8	8230.5	7168.5	6349.2	

Reference:24H=1 day,168H=1 week, 720H=1 month,8760H=1 year

Appendix-A

12.2 When Recording with a 160-GB HDD (Estimated with typical image-low noise level)

Lower : 15 kB
 Low : 19 kB
 Basic : 23 kB
 Standard : 27 kB
 High : 31 kB
 Superior : 35 kB

NTSC		system storage(GB): 160					
Recording Speed (IPS)	PICTURE QUALITY (KB)						
	LOWER	LOW	BASIC	STANDARD	HIGH	SUPERIOR	
	15	19	23	27	31	35	
60	49.4	39	32.2	27.4	23.9	21.2	
30	98.8	78	64.4	54.9	47.8	42.3	
20	148.1	117	96.6	82.3	71.7	63.5	
15	197.5	155.9	128.8	109.7	95.6	84.7	
10	296.3	233.9	193.2	164.6	143.4	127	
5	592.6	467.8	386.5	329.2	286.7	254	
1	2963	2339.2	1932.4	1646.1	1433.7	1269.8	
0.5	5925.9	4678.4	3864.7	3292.2	2867.4	2539.7	
0.3	9876.5	7797.3	6441.2	5487	4779	4232.8	
0.2	14814.8	11695.9	9661.8	8230.5	7168.5	6349.2	
PAL		PICTURE QUALITY (KB)					
Recording Speed (IPS)	LOWER	LOW	BASIC	STANDARD	HIGH	SUPERIOR	
	15	19	23	27	31	35	
50	59.3	46.8	38.6	32.9	28.7	25.4	
25	118.5	93.6	77.3	65.8	57.3	50.8	
10	296.3	233.9	193.2	164.6	143.4	127	
5	592.6	467.8	386.5	329.2	286.7	254	
2	1481.5	1169.6	966.2	823	716.8	634.9	
1	2963	2339.2	1932.4	1646.1	1433.7	1269.8	
0.5	5925.9	4678.4	3864.7	3292.2	2867.4	2539.7	
0.4	7407.4	5848	4830.9	4115.2	3584.2	3174.6	
0.2	14814.8	11695.9	9661.8	8230.5	7168.5	6349.2	
0.1	29629.6	23391.8	19323.7	16460.9	14336.9	12698.4	

Reference:24H=1 day,168H=1 week, 720H=1 month,8760H=1 year

13. View From Internet/Intranet

Basic Operations and Login Display:

Go to the Internet Explorer, key in the network IP address, for example, <http://192.168.10.5> (must be the same IP address as the one assigned to the unit from the Network Setting Menu.)

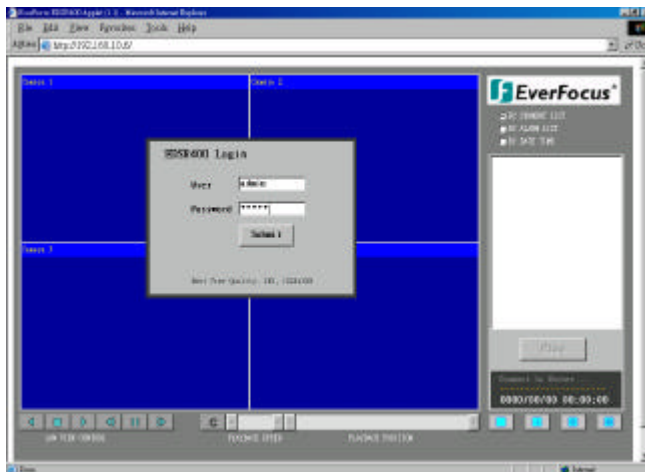

The “digital video recorder login” page will show on the screen”
User’ must enter the correct user-name and password defined in the
Network Setting menu.

For example:

Enter ADMIN for use name and ADMIN for password and then Click
On “submit” to enter to system.

Main Screen

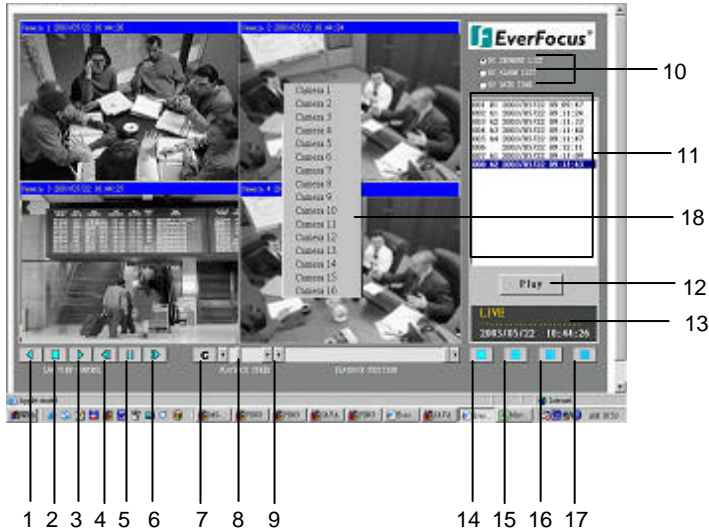







Above diagram is the main screen display.

The icons on the lower corner of the screen are mainly for control and Configuration, those on the right corner are for status indication.

If any icon is grayed, it means that the specific function is not accessible in the current mode.

The followings are a brief description for each of the icons.

- ①  **REV. PLAY** : Reverses Video display
- ②  **STOP** : Press this key to stop Video display..
- ③  **PLAY**: Playing back the Video display.
- ④  **Step Forward** the Video display.
- ⑤  **Step Backward** the Video display
- ⑥  **PAUSE**: Press this key to pause the Video display.
- ⑦  **C** Control Mode: This key will switch user to direct remote control mode.



Note: **C** Control Mode which only allow use with access level “Super” user..

⑧ Control for Playback Video Speed

⑨ Control for Playback Position

Appendix-C

- ⑩ The system allows up to 3 ways playback video, by SEGMENT,ALARM LIST and DATE TIME.

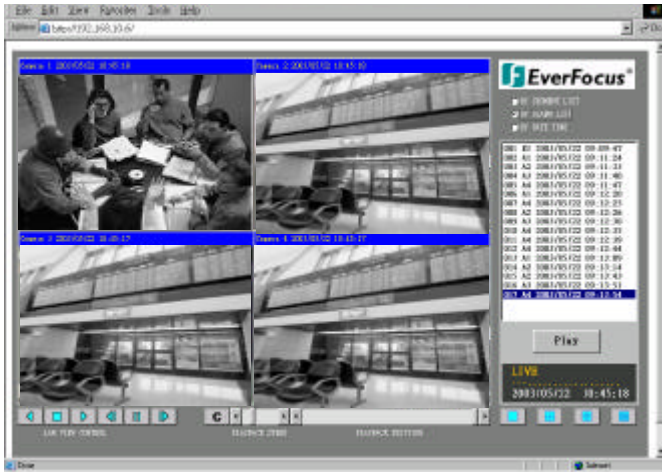

(playback by segment list)

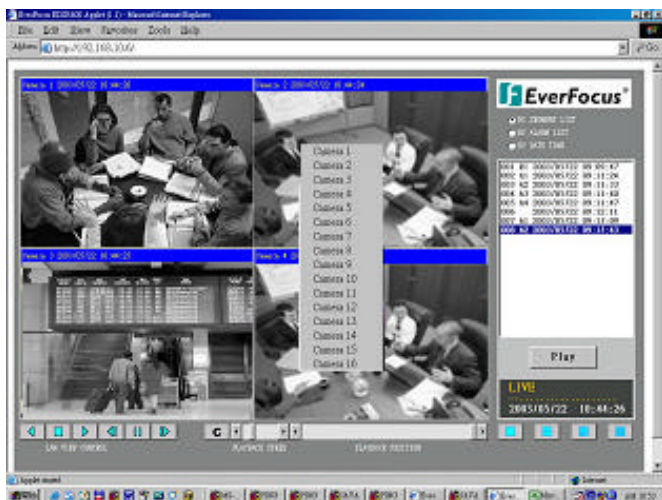

(playback by alarm list)



(playback by Date time)

Appendix-C

- ⑪ All available segments are shown in the list. Click to select and highlight.
- ⑫ Click to playback selected video segment.
- ⑬ Current connection and playback status is shown along with date and time.
- ⑭ Full screen view.
- ⑮ Quad screen view
- ⑯ Nine split screen view
- ⑰ Sixteen split screen view
- ⑱ A pop-up menu to select camera to view will be shown by pressing right mouse button.
*15,16,17,18 function are available with limited MUX.

LAN Functional Specification

Specifications:

Network Interface:	10Mbits/s Ethernet (10Base T)
LAN controller Chip:	RealTek 8019
LAN Connector:	RJ-45
Protocol:	HTTP,TCP/IP.ICMP,ARP
Remote Access:	Standard browser such as internet Explorer/Netscape with JAVA support.
Image Compress:	JPEG

EverFocus Electronics Corp.

Head Office:

12F, No.79 Sec. 1 Shin-Tai Wu Road,
Hsi-Chi, Taipei, Taiwan
TEL : 886-2-26982334
FAX : 886-2-26982380

USA Office:

2445 Huntington Drive, San Marino,
CA 91108, U.S.A.
TEL : 1-626-844-8888
FAX : 1-626-844-8838

Japan Office:

1809 WBG Marive East 18F,
2-6 Nakase.Mihama-ku.
Chiba city 261-7118, Japan
TEL : 81-43-212-8188
FAX :81-43-297-0081

Beijing Office:

Room 609, Technology Trade Building,
Shandgdi Information Industry Base,
Haidian District, Beijing,China
TEL : 86-10-62971096
FAX : 86-10-62971432

European Office:

Albert-Einstein-Strasse 1
D-46446 Emmerich, Germany
TEL : 49-2822-9394-0
FAX : 49-2822-939495



EverFocus[®]

P/N: MR4MG0011B