

# **Multicam Digital Surveillance System V8.2**



**User's Manual**

# Contents

Important Notice..... i

## 1

**Configuring Main System..... 5**

---

**System Configuration ..... 8**

- Configuring Global Recording Parameters ..... 9
- Adjusting Individual Camera ..... 16
- Setting Up Day - Night Recording Mode ..... 20
- Geo Mpeg4 (ASP) Advanced Settings ..... 21
- Multithreading Encoding ..... 22
- Configuring Hotline/Network Notification ..... 23
- Selecting Screen Layout..... 25
- Launching GV-System from System Tray ..... 26
- Camera / Audio Install ..... 27
- Setting Up Auto Reboot ..... 28
- Logging System Activities into System Log ..... 29
- Popping Up a Camera Window on Motion Detection ..... 31
- Different Text Alignment for Each Channel ..... 32
- Configuring Object Counting..... 33
- Mapping PTZ Cameras..... 36
- PTZ Idle Protection ..... 37
- Setting Up Password ..... 38
- Sending Alerts thru E-mail Accounts ..... 41
- Choosing Video Source ..... 43
- Adjusting Video Attributes..... 44
- Switching to Full-Screen View ..... 47
- Listening to Live Audio..... 47
- Stopping Video Lost Watchdog ..... 47
- Deactivating Video Lost Beep..... 47

**Start/Stop Monitoring..... 48**

**Playing Back Video Files ..... 49**

- Instant Playback ..... 49

**System Log ..... 50**

**Recording Schedule..... 55**

Video Schedule.....	56
Special Days Schedule.....	57
I/O Schedule .....	57
Center V2 Schedule.....	57
<b>PTZ Control Panel .....</b>	<b>58</b>
Auto Switching PTZ Control Panels .....	59
<b>PTZ Automation.....</b>	<b>60</b>
<b>Touch Screen Support.....</b>	<b>61</b>
PTZ and I/O Control Panel .....	61
Touch Screen Panel .....	61
<b>Retrieving Images Using Object Index.....</b>	<b>63</b>
Object Index Setup .....	63
Live Object Index .....	65
Object Index Search .....	66
<b>Face Detection.....</b>	<b>68</b>
<b>Detecting Unattended and Missing Objects.....</b>	<b>69</b>
Detecting Unattended Objects.....	69
Detecting Missing Objects .....	71
<b>Object Tracking and Zooming .....</b>	<b>74</b>
Object Tracking.....	74
Starting Object Tracking .....	78
Zooming in Objects.....	79
Object Zooming.....	80
Starting Object Zooming.....	82
<b>Configuring Hybrid Cameras .....</b>	<b>83</b>
<b>Privacy Mask Protection.....</b>	<b>84</b>
Setting Up a Privacy Mask.....	84
Granting Access Privileges to Recoverable Areas .....	85
<b>Scene Change Detection .....</b>	<b>86</b>
<b>Advanced Motion Detection.....</b>	<b>88</b>
<b>Hard Disk Calculator .....</b>	<b>90</b>
<b>Video Noise Solutions .....</b>	<b>92</b>
Noise Tolerance.....	92
Noise Detection to Reduce File Size .....	93
Noise Filter.....	94
<b>Panorama View .....</b>	<b>95</b>
Creating a Panorama View.....	97
Accessing a Panorama View .....	98

<b>Defogging Live Videos</b> .....	<b>99</b>
<b>Video Stabilization</b> .....	<b>100</b>
<b>Picture-in-Picture View</b> .....	<b>101</b>
<b>Picture-and-Picture View</b> .....	<b>102</b>
<b>DSP Spot Monitor Controller</b> .....	<b>103</b>
Spot Monitor Controller .....	103
Spot Monitor Panel .....	106
<b>Quad Spot Monitors Controller</b> .....	<b>107</b>
Setting up the Controller .....	107
Setting Pop-up Camera Windows.....	110
Displaying TV Quad Panel on the Main System Screen .....	111
Running the Quad Spot Monitors Controller Alone .....	112
<b>System Idle Protection</b> .....	<b>113</b>
Auto Logout Administrator .....	113
Auto Login User without Access Rights.....	114
Auto Start Recording .....	115
<b>Creating Shortcuts</b> .....	<b>116</b>
<b>Hybrid and NVR Solution</b> .....	<b>117</b>
GeoVision IP Video Products .....	117
Dongle Type.....	117
Hybrid Solution Description .....	118
NVR Solution Description .....	118
Adding IP Video Sources.....	119
Previewing Video and Setting Audio .....	121
Setting Up PTZ IP Camera .....	122
<b>Fast Key Lockup</b> .....	<b>123</b>
<b>Version Information</b> .....	<b>123</b>
<b>Fast Key Reference</b> .....	<b>123</b>
<b>PTZ Protocol and Model Support</b> .....	<b>124</b>
<b>USB Dongle Required for IP Device Applications</b> .....	<b>125</b>
<b>Supported IP Devices</b> .....	<b>126</b>
<b>Specifications</b> .....	<b>127</b>

## 2

## I/O Applications ..... 129

<b>Setting Up I/O Devices</b> .....	<b>129</b>
Latch Trigger.....	133



Keeping Last Toggle Status.....	135
<b>I/O Control Panel .....</b>	<b>137</b>
I/O Input Control Panel .....	137
I/O Output Control Panel .....	137
<b>Moving PTZ Camera to a Preset Location upon Alarm Event .....</b>	<b>138</b>
Deactivating Alarm and Alert Settings .....	139
<b>Detecting Input State .....</b>	<b>140</b>
<b>I/O Enable Setting.....</b>	<b>141</b>
<b>Advanced I/O Panel.....</b>	<b>142</b>
The Advanced I/O Panel.....	142
Creating a Group for Cascade Triggers .....	143
Configuring the Advanced I/O Panel .....	146
Setting Up Mode Schedule .....	147
Quick Link .....	149
Forcing Output .....	149
Editing Background Image.....	150
System-Wide Triggers .....	150
The “Advanced Logical Input Status in Mutlicam” Option .....	151
Managing a Group of I/O Devices .....	152
<b>Visual Automation.....</b>	<b>153</b>
Setting Up Visual Automation.....	153
Using Visual Automation.....	154
<b>Virtual I/O Control.....</b>	<b>155</b>
Setting Up a Module .....	156

## 3

### Point-Of-Sale (POS) Application..... 158

<b>POS System Connection .....</b>	<b>158</b>
POS Data Sender .....	159
<b>Setting a POS System.....</b>	<b>160</b>
<b>Superimposing POS Data onto Camera Screen .....</b>	<b>162</b>
<b>POS Field Filter.....</b>	<b>164</b>
<b>Abnormal Transaction Alerts.....</b>	<b>166</b>
Alarm Frequency Settings .....	167
<b>Codepage Mapping .....</b>	<b>168</b>
<b>Searching POS Data.....</b>	<b>169</b>
<b>POS Live View .....</b>	<b>170</b>

The POS Live View Window.....	170
Setting Up Live View.....	171
<b>POS Color Text.....</b>	<b>172</b>
Setting Up POS Color Text.....	172

# 4

## Playing Back Video Files ..... 176

<b>Playing Back on ViewLog.....</b>	<b>176</b>
Playback Screen Layout.....	180
Playback Control Buttons .....	181
A to B Playback Mode .....	181
Searching a Video Event .....	182
Timeline Search.....	184
Exporting Video.....	185
Extracting Frames from a Video Clip.....	188
Saving Images .....	189
Printing Images .....	190
Object Search .....	191
Searching and Playing Back Motion, Alarm, and POS Event .....	193
Advanced Setup .....	200
<b>Recycling Option for Video Files.....</b>	<b>206</b>
Unmarking All Never-Recycling Flags .....	206
Reserving Never-Recycling Flags .....	206
<b>Playing Back over Local Area Network (LAN).....</b>	<b>207</b>
<b>Playing Back over Internet Using Remote ViewLog Service.....</b>	<b>209</b>
Retrieving Recorded Video.....	209
Viewing Connection Status.....	210
Resuming Backup.....	211
<b>Accessing Recordings from Multiple Hosts.....</b>	<b>212</b>
<b>Playing Back over Internet Using Remote Playback .....</b>	<b>213</b>
Working with Remote Playback Server at the Server PC .....	213
Working with Remote Playback Client at the Client PC .....	215
<b>Touch Screen Support.....</b>	<b>222</b>
<b>Fast Key Reference .....</b>	<b>223</b>
<b>Specifications .....</b>	<b>223</b>

# 5

## Backing Up and Deleting Files ..... 225

Backing Up Files Using Backup System .....	225
Backing Up Log Data Using System Log.....	229
Backing Up Files Using ViewLog .....	230
Splitting Files for Backup onto Multiple Discs.....	233
Backing Up at the Client PC.....	235
Deleting Files Using Backup System.....	236
Deleting Files Using ViewLog .....	237
Repairing Damaged File Paths .....	238
Repairing Damaged Video Files .....	239

# 6

## Viewing Live Video Using WebCam ..... 243

<b>Configuring WebCam Server .....</b>	<b>243</b>
WebCam Server Settings .....	243
UPnP Settings.....	252
FTP Server Settings .....	255
Network Port Information .....	256
<b>Accessing Live Video Using a Web Browser .....</b>	<b>257</b>
<b>Single View MPEG4 Encoder Viewer.....</b>	<b>259</b>
Control Panel .....	260
Administrating Host Server .....	262
Taking a Snapshot from a Live Video.....	263
Pop-Up Setup .....	264
Video and Audio Configuration .....	265
Exporting Video.....	266
PTZ Control.....	266
I/O Control.....	267
Visual Automation.....	268
Visual PTZ .....	268
Display of Video Resolution.....	269
Picture-in-Picture View .....	269
Picture-and-Picture View .....	269
Image Enhancement.....	270

Remote Configuration .....	270
<b>2-Window MPEG4 Encoder Viewer.....</b>	<b>272</b>
<b>Multi View MPEG4 Encoder Viewer .....</b>	<b>273</b>
Starting MultiView .....	273
Working With the Host Server Window .....	275
Working with Hosts on the Same LAN .....	275
Exporting Video.....	276
Taking a Snapshot from a Live Video.....	276
PTZ Control.....	276
Output Control.....	277
Channel Status Information .....	277
Camera Polling Function .....	278
Two-Way Audio.....	278
Display of Video Resolution.....	278
Multi View Configuration.....	279
Creating a Quick Connection to a Host Server.....	280
Creating Multiple Hosts.....	281
Camera Status.....	283
Host Information.....	284
Remote ViewLog .....	285
<b>JPEG Image Viewer.....</b>	<b>286</b>
<b>Remote Playback on WebCam.....</b>	<b>287</b>
Searching and Playing Back Recorded Files .....	288
Synchronizing Audio with Video Playback.....	289
DirectDraw Setup.....	289
Searching Object Index .....	289
Advanced Search .....	290
<b>Remote ViewLog on WebCam .....</b>	<b>292</b>
<b>Event List Query.....</b>	<b>293</b>
<b>POS Live View on WebCam .....</b>	<b>294</b>
The Remote POS Live View Window .....	294
Instant Playback .....	295
<b>Download Center.....</b>	<b>296</b>
<b>Mobile Phone Applications .....</b>	<b>297</b>
PDA.....	298
I-Mode Phone .....	303
Windows Smartphone.....	305
Symbian Smartphone .....	307

Fast Key Reference ..... 309

# 7

## E-Map Application ..... 311

**The E-Map Editor ..... 311**  
    The E-Map Editor Window ..... 312

**Creating an E-Map File ..... 313**  
    Creating an E-Map File for a Remote Host ..... 314

**Starting E-Map ..... 315**  
    Setting the Pop-up Map Function ..... 316

**Starting E-Map from a Remote Site ..... 317**  
    The Remote E-Map Window ..... 317  
    Logging in Different Hosts ..... 318  
    Configuring the Remote E-Map Window ..... 319  
    Viewing Host Information ..... 320  
    Accessing Remote ViewLog ..... 321

**E-Map Server ..... 322**  
    Installing E-Map Server ..... 322  
    The E-Map Server Window ..... 322  
    Setting E-Map Server ..... 323  
    Remote Monitoring via E-Map Server ..... 323  
    Accessing Authentication Server Account Information ..... 323

# 8

## Live Viewing Using Remote Applications .... 325

**Remote View ..... 325**  
    Setting Up Remote View ..... 325  
    Working with My Favorite ..... 328  
    Camera Zoom Function ..... 329  
    Playing with Screen View Window Functions ..... 329  
    Playing Back Video Files in Q-View ..... 330  
    Preference Settings ..... 330  
    Remote PTZ and I/O Function ..... 332  
    Full Screen View ..... 333

**IP Multicast ..... 334**  
    Setting Up IP Multicast ..... 334

Starting IP Multicast.....	334
----------------------------	-----

## 9

### Short Message Service ..... 337

<b>Installing SMS Server.....</b>	<b>337</b>
<b>The SMS Server Window .....</b>	<b>338</b>
<b>SMS Server Setup .....</b>	<b>339</b>
Device Settings .....	339
Server Settings .....	340
Account Settings.....	343
<b>SMS Log .....</b>	<b>345</b>
Setting SMS Log.....	345
Viewing SMS Log .....	345
<b>Password Security .....</b>	<b>347</b>
<b>Connecting GV-System to SMS Server.....</b>	<b>347</b>
<b>Setting Mobile Numbers .....</b>	<b>349</b>

## 10

### Useful Utilities ..... 352

<b>Dynamic DNS.....</b>	<b>352</b>
Installing Dynamic DNS .....	352
Registering Domain Name with DDNS.....	353
<b>Starting Dynamic DNS .....</b>	<b>355</b>
<b>TwinDVR System.....</b>	<b>356</b>
Starting TwinServer .....	358
Installing TwinDVR .....	360
Starting TwinDVR .....	360
TwinDVR Settings.....	363
<b>Watermark Viewer .....</b>	<b>364</b>
<b>Twin View Display .....</b>	<b>366</b>
<b>Windows Lockup.....</b>	<b>368</b>
The GV-Desktop Screen.....	368
GV-Desktop Features .....	369
<b>Token File for Save Mode.....</b>	<b>372</b>
<b>Authentication Server .....</b>	<b>373</b>
Installing the Server .....	373

The Server Window .....	373
Creating a DVR List .....	375
Editing a User .....	376
Starting the Server .....	377
Connecting GV-System to the Server .....	378
Backup Servers .....	380
Remote Access from Control Center, Remote E-Map and MultiView .....	381
<b>Fast Backup and Restore .....</b>	<b>384</b>
Installing the FBR Program.....	384
Running the FBR Program .....	384
Selecting a Skin .....	385
Customizing the Features.....	386
Backing up and Restoring Settings .....	387
<b>Hot-Swap Recording .....</b>	<b>389</b>
The Media Man Tool Window .....	390
Viewing Disk Drive Status.....	391
Adding a Disk Drive .....	393
Removing a Disk Drive .....	394
Auto Logging In and Minimizing Media Man Tools Window.....	395
Setting Up LED Panel.....	396
<b>Backup Server .....</b>	<b>398</b>
Usage Requirement.....	398
Connecting to the Storage System .....	399
Advanced Settings .....	400
Manually Adding Files for Backup .....	403
Viewing Server Status .....	404
Retrieving Recorded Files .....	407
<b>Backup Viewer .....</b>	<b>408</b>
Usage Requirements .....	408
Installing Backup Viewer.....	408
Starting Backup Viewer .....	409
Performing Queries.....	410
Viewing the Event Files .....	410
Using Remote ViewLog .....	412
<b>Bandwidth Control Application .....</b>	<b>413</b>
Running the Bandwidth Control.....	414
Allowing Remote Control at DVR.....	415
Connecting to a WebCam Server .....	415

Controlling a WebCam Server .....	416
Bandwidth Setup.....	417
Block List Setup .....	418
General Setup.....	419
<b>Report Generator.....</b>	<b>420</b>
Starting Report Generator .....	420
Setting Up Report Generator .....	420
Setting Up Report Criteria.....	422
E-Mail Attachment Settings .....	425
Playing Back the Video Recording .....	426
Viewing Event Log .....	426

Troubleshooting.....	427
----------------------	-----



## Important Notice

The version 8.2 only supports the following GV video capture cards:

- GV-250 All Series
- GV-600(S) V3.20 and later
- GV-650(S) V3.30 and later
- GV-800(S) V3.30 and later
- GV800-4A V3.10 and later
- GV-600(V4)
- GV-650(V4)
- GV-800(V4)
- GV-1120 All Series
- GV-1240 All Series
- GV-1480 All Series
- GV-2004
- GV-2008

For more information on the upgrade, please visit our website at [http://www.geovision.com.tw/english/5\\_0.asp](http://www.geovision.com.tw/english/5_0.asp), or contact your dealer.

## New Features in Version 8.2

Features	Page
<b>Chapter 1 Configuring Main System</b>	5
New Codec Option	19
Multithreading Recording	22
Panorama View	95
Defogging Live Videos	99
Video Stabilization	100
Picture-in-Picture View	101
Picture-and-Picture View	102
Video and Audio Noise Solutions	92
Hybrid Solution	117
NVR Solution	117

<b>Chapter 2 I/O Applications</b>	129
Combining Up To 16 I/O Devices Into One Module	156
<b>Chapter 3 Point-Of-Sale (POS) Application</b>	158
Alarm Frequency	167
<b>Chapter 4 Playing Back Video Files</b>	176
New Video Enhancement Effects	187
Support for Picture-in-Picture View	180
Support for Picture-and-Picture View	180
Support for Panorama View	180
Extracting a Clip of Set Frames from a File	188
Removing audio noise during playback.	202
Accessing Recordings from Multiple Hosts	212
<b>Chapter 5 Backup Up and Deleting Files</b>	225
Splitting Files for Backup onto Multiple Discs	233
<b>Chapter 6 Viewing Live Video Using WebCam</b>	243
New Web GUI	257
Single View Enhancements	259
Multi View Enhancements	273
Remote Playback Enhancements	287
Download Center	296
<b>Chapter 9 Short Message Service</b>	337
Added Event Alerts	341
<b>Chapter 10 Useful Utilities</b>	352
Remote Access from Control Center, Remote E-Map and MultiView	381
Enhanced Media Man Tool program	390
Backup Server	398
Backup Viewer	408
Bandwidth Control	413
Report Generator	420

# Chapter 1

---

Configuring Main System.....	5
<b>System Configuration .....</b>	<b>8</b>
Configuring Global Recording Parameters.....	9
Adjusting Individual Camera.....	16
Setting Up Day - Night Recording Mode .....	20
Geo Mpeg4 (ASP) Advanced Settings .....	21
Multithreading Encoding .....	22
Configuring Hotline/Network Notification.....	23
Selecting Screen Layout.....	25
Launching GV-System from System Tray .....	26
Camera / Audio Install.....	27
Setting Up Auto Reboot .....	28
Logging System Activities into System Log.....	29
Popping Up a Camera Window on Motion Detection .....	31
Different Text Alignment for Each Channel.....	32
Configuring Object Counting .....	33
Mapping PTZ Cameras .....	36
PTZ Idle Protection .....	37
Setting Up Password .....	38
Sending Alerts thru E-mail Accounts .....	41
Choosing Video Source .....	43
Adjusting Video Attributes.....	44
Switching to Full-Screen View .....	47
Listening to Live Audio.....	47
Stopping Video Lost Watchdog.....	47
Deactivating Video Lost Beep .....	47
<b>Start/Stop Monitoring.....</b>	<b>48</b>
<b>Playing Back Video Files .....</b>	<b>49</b>
Instant Playback .....	49
<b>System Log.....</b>	<b>50</b>
<b>Recording Schedule.....</b>	<b>55</b>

Video Schedule.....	56
Special Days Schedule.....	57
I/O Schedule.....	57
Center V2 Schedule.....	57
<b>PTZ Control Panel .....</b>	<b>58</b>
Auto Switching PTZ Control Panels .....	59
<b>PTZ Automation.....</b>	<b>60</b>
<b>Touch Screen Support .....</b>	<b>61</b>
PTZ and I/O Control Panel .....	61
Touch Screen Panel .....	61
<b>Retrieving Images Using Object Index .....</b>	<b>63</b>
Object Index Setup .....	63
Live Object Index.....	65
Object Index Search .....	66
<b>Face Detection.....</b>	<b>68</b>
<b>Detecting Unattended and Missing Objects.....</b>	<b>69</b>
Detecting Unattended Objects.....	69
Detecting Missing Objects .....	71
<b>Object Tracking and Zooming.....</b>	<b>74</b>
Object Tracking.....	74
Starting Object Tracking .....	78
Zooming in Objects.....	79
Object Zooming .....	80
Starting Object Zooming.....	82
<b>Configuring Hybrid Cameras.....</b>	<b>83</b>
<b>Privacy Mask Protection.....</b>	<b>84</b>
Setting Up a Privacy Mask .....	84
Granting Access Privileges to Recoverable Areas .....	85
<b>Scene Change Detection .....</b>	<b>86</b>
<b>Advanced Motion Detection .....</b>	<b>88</b>
<b>Hard Disk Calculator .....</b>	<b>90</b>
<b>Video Noise Solutions .....</b>	<b>92</b>

Noise Tolerance .....	92
Noise Detection to Reduce File Size .....	93
Noise Filter.....	94
<b>Panorama View .....</b>	<b>95</b>
Creating a Panorama View.....	97
Accessing a Panorama View .....	98
<b>Defogging Live Videos.....</b>	<b>99</b>
<b>Video Stabilization.....</b>	<b>100</b>
<b>Picture-in-Picture View .....</b>	<b>101</b>
<b>Picture-and-Picture View .....</b>	<b>102</b>
<b>DSP Spot Monitor Controller .....</b>	<b>103</b>
Spot Monitor Controller.....	103
Spot Monitor Panel .....	106
<b>Quad Spot Monitors Controller .....</b>	<b>107</b>
Setting up the Controller.....	107
Setting Pop-up Camera Windows .....	110
Displaying TV Quad Panel on the Main System Screen.....	111
Running the Quad Spot Monitors Controller Alone.....	112
<b>System Idle Protection.....</b>	<b>113</b>
Auto Logout Administrator .....	113
Auto Login User without Access Rights.....	114
Auto Start Recording.....	115
<b>Creating Shortcuts .....</b>	<b>116</b>
<b>Hybrid and NVR Solution.....</b>	<b>117</b>
GeoVision IP Video Products .....	117
Dongle Type.....	117
Hybrid Solution Description .....	118
NVR Solution Description .....	118
Adding IP Video Sources.....	119
Previewing Video and Setting Audio.....	121
Setting Up PTZ IP Camera .....	122
<b>Fast Key Lockup.....</b>	<b>123</b>
<b>Version Information.....</b>	<b>123</b>

<b>Fast Key Reference .....</b>	<b>123</b>
<b>PTZ Protocol and Model Support.....</b>	<b>124</b>
<b>USB Dongle Required for IP Device Applications .....</b>	<b>125</b>
<b>Supported IP Devices .....</b>	<b>126</b>
<b>Specifications .....</b>	<b>127</b>

## Configuring Main System

The system prompts you for a Supervisor ID and Password when starting the system for the first time, shown as below:



**Figure 1-1**

Enter a name you wish to be the Supervisor ID in the ID field. Finish the setup by entering Password, Password Confirmation, and a Hint (optional) that would remind you of the password. Messages entered at the Hint field will only pop up when passwords are entered incorrectly.

- **Auto Login:** Allows auto login as the current user every time when the system is launched. For security purposes, this feature is only recommended for single-user systems.
- **Allow removing password System:** For this setting, see *Setting Up Password* later in this chapter.
- : Click to open the onscreen keyboard and enter the login information.

After setting up the Supervisor ID and Password, launch the program to enter the Main System.

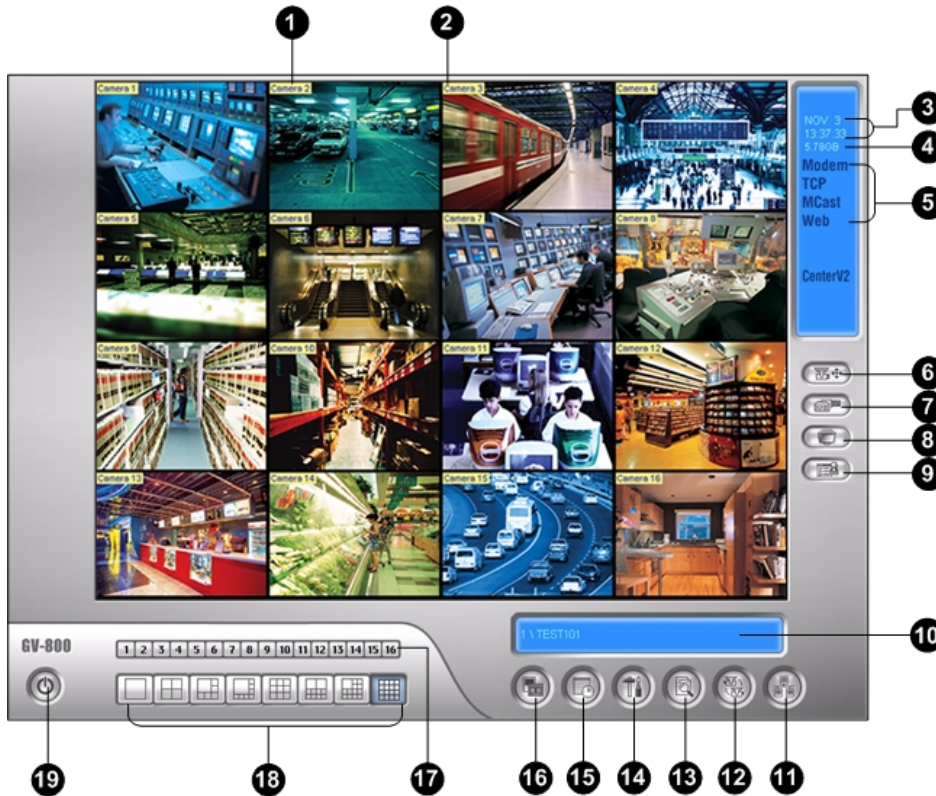

Figure 1-2

The controls in the main screen:

No.	Name	Description
1	Camera Number	Indicates the camera number matching the port number in the GV video capture card.
2	Camera Name	Indicates the given camera name.
3	Date/Time	Displays the current date and time.
4	Storage Space	Indicates the remaining disk space.
5	Connection	Indicates the connection status of remote applications.
6	PTZ Control	Displays the PTZ control panel.
7	I/O Control	Displays the I/O control panel.
8	TV-Out	Displays the TV Quad control panel.
9	User-Defined	Accesses other applications.
10	Location Name	Indicates the GV-System's name, usually named by its geographical location.
11	Network	Enables the connection to remote applications.
12	Camera Scan	Rotates through the screen divisions.
13	ViewLog	Brings up these options: Video/Audio Log, System Log, Search POS Data, POS Live View, Live Object Index, Search Object Index and E-Map.



---

14	Configure	Accesses System settings.
15	Schedule	Set up recording schedule.
16	Monitor	Starts monitoring.
17	Camera Select	Select the desired camera number for main division view.
18	Screen Division	Select screen divisions.
19	Exit	Brings up these options: Login/Change User, Logout, Minimize, Restart Multicam and Exit.

---

Press **[F7]** on the keyboard, or click the **Monitor** button to start recording. By default, every camera records with the following settings:

- In Motion Detection mode
- With the 320 x 240 resolution
- With Geo Mpeg4-ASP codec

When working with the system, you will undoubtedly want to change the settings as you go along. The buttons provide quick access to several popular Main System settings. Click any button to see the menus of these settings. Let's start with the Configure button.

## System Configuration

Click the **Configure** button (No.14, Figure 1-2), point to **General Setting** and select **System Configure**. You may configure cameras and global recording parameters in this dialog box. Changes made to the **General Setting** tab would apply to all available cameras attached to the system. In the **Camera Record Setting** tab, you can configure each individual camera. In the **I/O Device** tab, you can add and configure I/O devices. In the **HotLine/Network** tab, you can configure the system for connection to network or mobile.

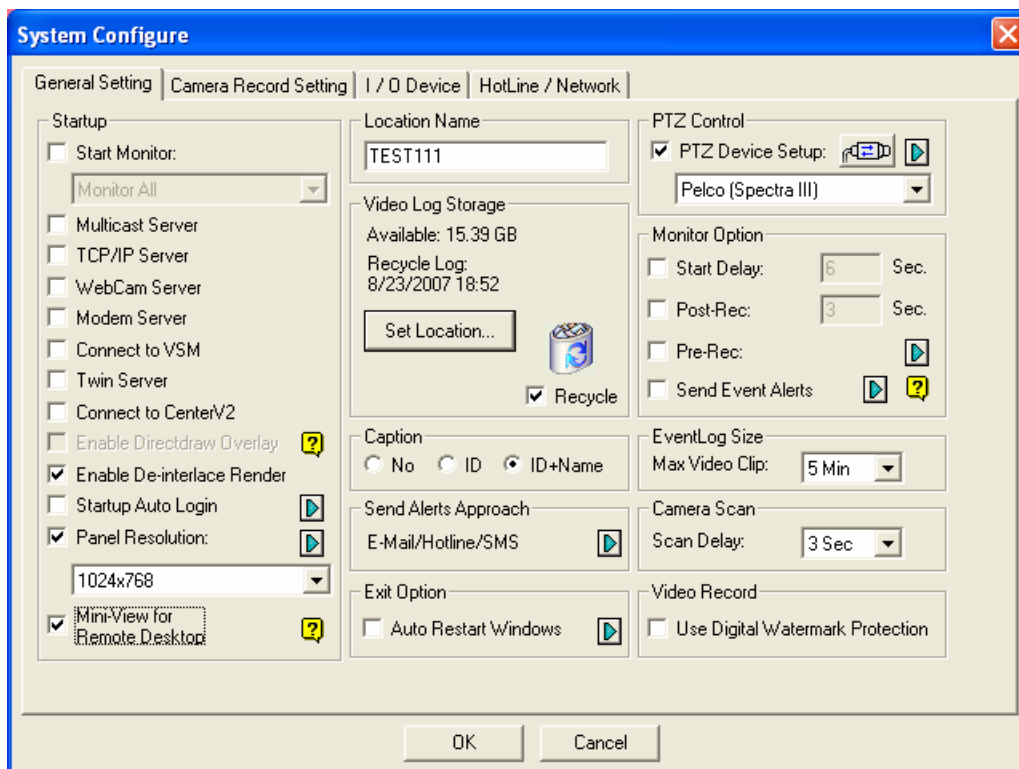

Figure 1-3

## Configuring Global Recording Parameters

Let's start with the options on the General Setting tab:

**[Startup]** The Startup options instruct the system to enable selected features at system startup.

- **Start Monitor:** Select one of the following monitor control modes at system startup:
  - ⊙ **Monitor All:** Allows you to monitor all cameras and I/O (if available) at system startup. It is the same as to manually click **Monitor** button (No. 16, Figure 1-2) and select **Start All Monitoring**. (For details, see *Start/Stop Monitoring* later in this chapter).
  - ⊙ **Schedule Monitor:** Allows you to monitor cameras by schedule. Alternatively you may click **Schedule** button and select **Schedule Start** (No. 15, Figure 1-2). Refer to *Recording Schedule* later in this chapter.
  - ⊙ **I/O Monitor:** Allows you to monitor all I/O devices. Alternatively you may click the **Monitor** button (No. 16, Figure 1-2), and then select **I/O Monitoring**.

---

**Note:** To set different recording modes and alert methods for each camera, see *[Monitor Control], Adjusting Individual Camera* later in this chapter.

---

- **Multicast Server:** Allows connection to IP Multicast (one of the remote application) at system startup. (Or click the **Network** button (No. 11, Figure 1-2) and select **Multicast Server**.)
- **TCP Server:** Allows connection to Remote View (another remote application) by TCP. (Or click the **Network** button (No. 11, Figure 1-2) and select **TCP Server**.)
- **WebCam Server:** Allows connection to WebCam Server at startup. (Or click the **Network** button (No. 11, Figure 1-2) and select **WebCam Server**.)
- **Modem Server:** Allows connection to Remote View by a modem. (Or click the **Network** button (No. 11, Figure 1-2) and select **Modem Server**.)
- **Connect to VSM:** Allows connection to VSM Server (Or click the **Network** button (No. 11, Figure 1-2) and select **Connect to VSM**.)
- **Twin Server:** Allows connection to Twin Server at startup. (Or click the **Network** button (No. 11, Figure 1-2) and select **Twin Server**). For more details, see *Twin DVR System* in Chapter 10.
- **Connect to CenterV2:** Allows connection to CenterV2. (Or click the **Network** button (No. 11, Figure 1-2) and select **Connect to CenterV2**.)
- **Enable Directdraw Overlay:** Enables full-screen at startup. (For the related applications, see *Switching to Full-Screen View* later in this chapter).
- **Enable De-interlace Render:** Avoids interlace of the odd and even video lines. This feature affects only single view mode with the resolution of 640 x 480 and 720 x 480. After enabling the feature, you must restart the GV-System to apply it.

---

**Note:**

1. The **Enable Directdraw Overlay** and **De-interlace Render** features can greatly enhance image quality. If your VGA card supports DirectX9, enable both settings.
  2. You may see a warning message "*Directdraw Create Overlay Failed*" when trying to use WebCam Remote Control to connect to a server. The message indicates the server has the Enable Directdraw Overlay feature enabled. It only means the remote side will not see the images with DirectDraw applied. It is safe to press **YES** to continue the connection.
- 

**Tip:** To check the version of your DirectX, search for the file name **dxdiag**. Open the file and find the related information. DirectX 9.0c is also included in the Surveillance System Software CD.

- **Startup Auto Login:** Select and press the **Arrow** button to assign an ID used at system auto startup. After the setup, the system will automatically login using this ID at next startup, without asking for ID and Password. For related settings, see *Launching GV-System from System Tray* later in this chapter.
  - **Panel Resolution:** Select the resolution from the drop-down list that best fits your computer monitor screen.
  - **Mini-View for Remote Desktop:** Squeezes all video channels into a single 320x240 view. Since you may use Microsoft Remote Desktop (a feature that comes with Windows XP Professional Edition) to set up the Main System through network, it is important to get smallest size possible data to transfer over network.
1. Click the **Configure** button (No.14, Figure 1-2), point to **General Setting**, and then select **System Configure**.
  2. In the System Configure dialog box, select **Mini-View for Remote Desktop** in the Startup section, and then click **OK** to apply the setting.
  3. Restart the Main System.
  4. To switch between the mini and normal view, click the **Configure** button (No.14, Figure 1-2), point to **A/V Setting** and select **Mini-View Switch**.



Figure 1-4 Mini View

**[Location Name]** The given name (maximum 14 characters) is displayed in main screen as the name of the server.

**[Video Log Storage]** Select storage type (recycle or not recycle) and location.

- **Available:** Shows remaining hard disk space.
- **Recycle Log:** Indicates the recording date of the next video file to be erased.
- **Set Location:**
  - ⊙ **Database Folder:** You can specify a new location for the database. The database location determines where the records of ViewLog Event List (Cam\*.db and Aud\*.db) are stored.
  - ⊙ **Storage Group Folder:** You can create the maximum of 8 storage groups with different storage locations, keep dates and recycle sizes to store video files.

To create a storage group:

1. Select **Storage Group Folder**. This dialog box appears.

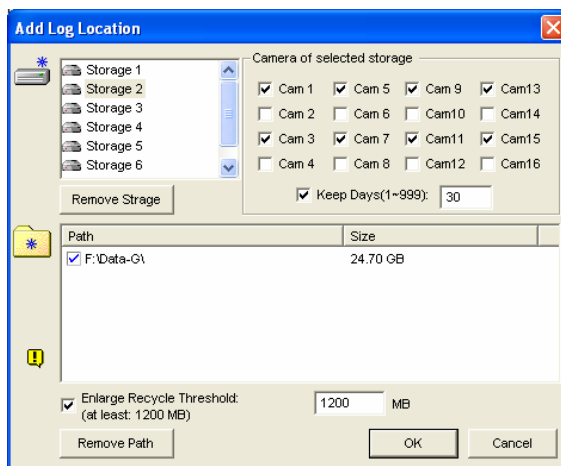



Figure 1-5

2. Click the **Add Storage Group** icon  to add a storage group. The first Storage Group is created by default.
3. Check the Cameras to be contained in the storage group.
4. Check the **Keep Days** option and specify the number of days to keep the video files in storage.
5. Click the **Add New Path** icon  to specify a storage location.
6. Check the **Enlarge Recycle Threshold** option and specify the size if you like to enlarge the default recycle size.
7. Click **OK**.

- **Recycle:** When this option is selected, it will cause the oldest files to be deleted when the system requires storage space for new surveillance videos. If it is not selected, the system will stop recording when disk space is full.
- **Keep Days:** Set to keep the files in storage for a set number of days. Users may specify to recycle at 1 to 999 days. If the designated storage space is not big enough to keep all video files for the defined days, the Recycle setting then overrides the Keep Days setting.

---

**Note:**

1. The video capture cards and GV-NVR have different default recycle sizes. When the storage space meets the default recycle size, the system will overwrite the oldest files. The default recycle size:
  - GV-250 / 600 / 650 / 800 is 800 MB.
  - GV-1120 / 1240 / 1480 is 1.2 GB.
  - GV-2004 / 2008 is 2 GB.
  - GV-NVR is 2 GB.Every time the 400 MB of old files will be deleted upon reaching the default limit.
2. When one partition fell short than the minimum storage space, video files will automatically be saved to next available hard disk; when total available storage space is lower than minimum, the system will stop recording and show a *Disk Space Low!* message.

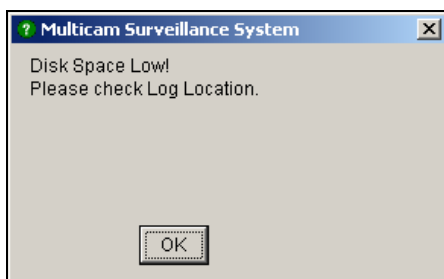

**Figure 1-6**

To solve the space shortage problem, you may add more hard disk space to the system, or to delete/back up your video files for more storage space. To correctly delete or back up video files, see Chapter 5 for more details.

**[Caption]** Enters heading to have it displayed on the upper left-hand corner of the camera screen. You may choose No for no heading; ID to show only camera ID; ID+Name to show both camera ID + Name.

**[Send Alerts Approach]** Click the arrow button to choose whether to be notified by E-mail, telephone or SMS when alert conditions occur under the surveillance area.

For the telephone setup, see *Configuring Hotline/Network Notification* later in this chapter.

For the E-mail setup, see *Sending Alerts thru E-Mail Accounts* later in this chapter.

For the SMS setup, see *Short Message Service* in Chapter 9.

**[Exit Option]** Check the box to enable the feature. Press the blue **Arrow** button to switch between **Auto Shutdown Windows** and **Auto Restart Windows**. **Auto Shutdown Windows** closes Windows OS after exiting GV-System. **Auto Restart Windows** restarts Windows OS after exiting GV-System.

**[PTZ Control]** Adds PTZ cameras to the system. See operation details in *PTZ Control Panel* later in this chapter.

#### **[Monitor Option]**

- **Start Delay:** Starts monitoring after x second(s) when the system is activated.
- **Post-Rec Motion:** Keeps on recording for a set period of time (1-10 seconds) after motion stops.
- **Pre-Rec Motion:** Records video for a set period of time before motion starts. This feature allows you to choose RAM or HDD as a pre-recording buffer. The difference between the two is that RAM can save smaller pre-record from 1 second to 1.5 minutes, while the hard disk can save larger one from 1 minute to 45 minutes.

1. Enable the **Pre-Rec Motion** option.
2. Click the **Arrow** button beside. This dialog box appears.

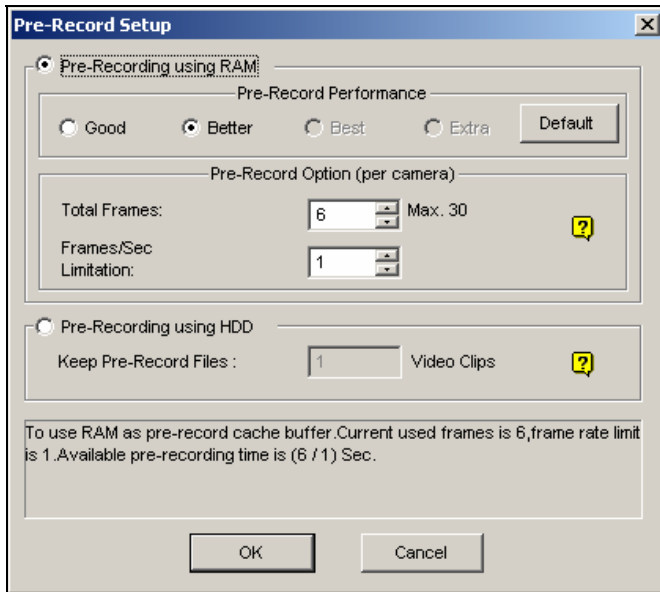

**Figure 1-7**

**[Pre-Record Performance]** The amount of physical memory of the computer that the system is running on determines the pre-recording performance. Some options are grayed out if the computer does not have enough memory for the selections.

This table shows the maximum pre-recording frame rate and the physical memory requirements of each setup:

	Good	Better	Best	Extra
Maximum pre-recording frames per camera (fps)	15 fps	30 fps	60 fps	90 fps
RAM required	128 MB	256 MB	512 MB	768 MB

**Note:** The recording frame rate is based on a 320x240 recording size.

**[Pre-Record Option (per camera)]** Determines the number of pre-record frames.

- **Total Frames:** Specify the maximum pre-recording frames of the system.
- **Frame/Sec Limitation:** Specify the maximum pre-recording frame rate (fps) of a camera.

Dividing the Total Frames by Frames/Sec Limitation, you will get the pre-recording duration of each camera. For example:

$$\text{Pre-recording duration} = \frac{\text{Total Frames}}{\text{Frame/Sec Limitation}} = \frac{30}{6} = 5 \text{ seconds}$$

**[Pre-Recording using HDD]** Use the hard disk as a pre-recording buffer. This method gives you much longer pre-recording time.



- **Keep Pre-Record Files:** Specify the number of video clips for pre-record. The maximum number of video clips you can specify is 9, and the time range of one video clip is from 1 minute to 5 minutes. So the pre-recording time can be from 1 minute to 45 minutes. For the video clip, see *[EventLog Size]* below.
- **Send Event Alerts:** Allows you to send out the assigned E-Mail/Hotline/SMS notification when the selected alert conditions occur. To enable the function, follow the steps below.
  1. Check the **Send Event Alerts** option, and click the **Arrow** button beside to display this dialog box.



**Figure 1-8**

2. Select the desired alert events to send out the assigned notification, and then click **OK** for the application.

The alert events of Intruder Event, Missing Object, Unattended Object, and POS Loss Prevention Event are only available when the alarm settings are activated in Counter Application, Object Monitor, and POS Application separately.

---

**Note:** To select the type of notification, see *[Send Alerts Approach]* earlier in this chapter.

---

**[EventLog Size]** Determines the amount of time (from 1 to 5 minutes) of each event file. If you select **5 Min**, a 30-minute event will be chopped into six 5-minute event files; if you select **1 Min**, a 30-minute event will be chopped into thirty 1-minute event files. To decide what to set up here, consider how often you back up your event files, and how intensive the activity is in your surveillance area. Smaller file size makes backup process faster.

**[Camera Scan]** Select to rotate through screen divisions. Click the drop-down list and specify the amount of time that elapses before switching to the next screen division group. Press the **Arrow** button to select the mode of screen divisions.

**[Video Record]** Click to watermark all recorded videos. Watermark is a way to verify the authenticity of video streams, and to ensure that they have not been tampered with or modified in any way. For details, see *Watermark Viewer* in Chapter 10.

## Adjusting Individual Camera

Click the **Configure** button (No. 14, Figure 1-2), point to **General Setting**, select **System Configure**, and then click the **Camera Record Setting** tab. This dialog box appears.

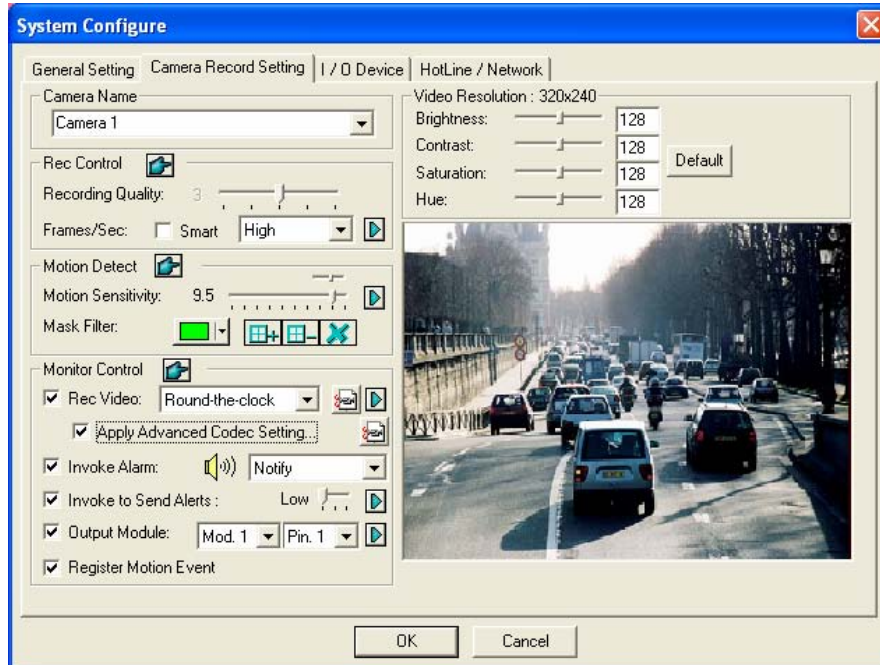
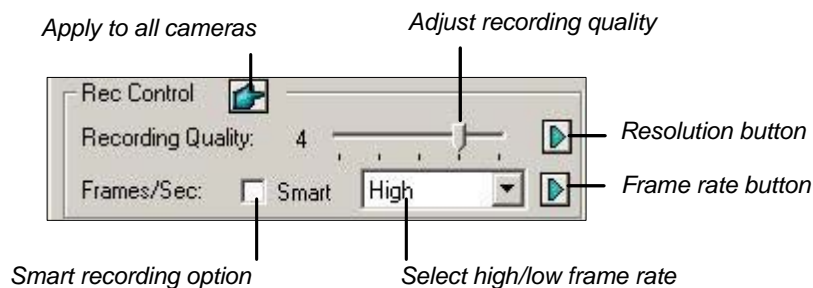

**Figure 1-9** Camera Settings

Several settings could be configured here:

**[Camera Name]** The name entered here will appear in the upper-left hand corner of the camera screen. You can use the drop-down list to select the camera to be configured.

**[Rec Control]** The Rec Control section allows you to set each camera's recording quality. The camera's recording quality is based on its resolution and compression rate. Higher-quality picture will require more storage space.



**Figure 1-10**

- **Recording Quality:** Allows you to adjust the video quality in 5 levels. Higher value means lower compression rate.

- **Resolution Button:** This button is only available after you change the default video resolution (see *Choosing Video Source* later in this chapter). Click to select recording resolutions.
- **Frame/Sec:** Allows you to adjust camera’s recording frame rate. There are three options available: Smart, High, and Low.
  - ⊙ **Smart:** The system will distribute as many frame rates as possible to the camera where motion occurs.
  - ⊙ **High:** The system will distribute high percentage of frames (not a definite frame number) to the selected camera while the other cameras will share rest of the frame rates. Assuming that all cameras are in action, selecting **High** ensures this camera always receive higher frame rate than the rest of the cameras. Effect can be seen in live mode.
  - ⊙ **Low:** The system will distribute low percentage of frame rates to the selected camera. Assuming that all cameras are in action, certain cameras are of least importance. The system can be set **Low** in order to allow frame rate to go to more important cameras.
- **Frame Rate Button:** Allows you to set the maximum recording frame of this camera so as to save storage space.

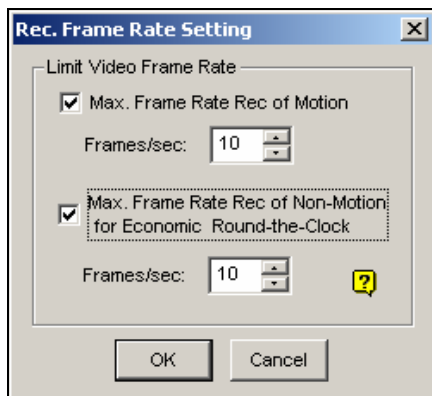
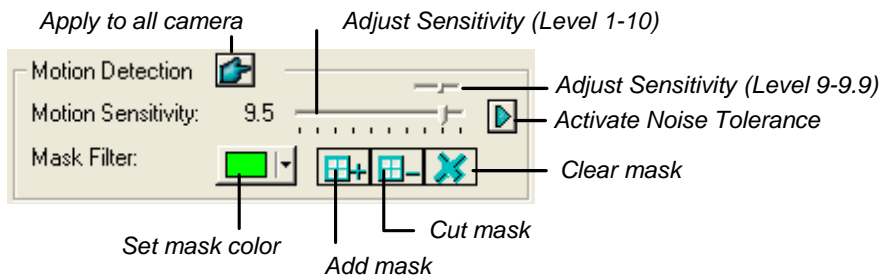

Figure 1-11 Frame Rate Settings

- ⊙ **Max. Frame Rate Rec of Motion:** Set the maximum frame rate on motion detection. For example, if you set 10 Frames/sec in the field, the maximum frame this camera will record is 10 frames/second. This setting does not mean it always records at 10 frames/second because the actual recording frame rate is also affected by other settings in the system and CPU loading.
- ⊙ **Max. Frame Rate Rec of Non-Motion for Economic Round-the-Clock:** This option provides a space-saving solution for the round-the-clock recording. Set the maximum frame rate for non-motion periods so as to save as much storage space as possible.

**[Motion Detection]**



**Figure 1-12**

- **Motion Sensitivity:** There are 10 levels of sensitivity for motion detection. And there are further sublevels from 9 to 9.9. The default value is set to 9.5. The higher the value, the more sensitive the system is to the motion.
- **Mask Filter:** Mask instructs the system to ignore movement within the masked area. Mask could be applied to repetitive motion that should be ignored within the surveillance area, such as street trees.
- **Noise Tolerance:** This function reduces false alarms and unwanted recordings caused by weather or light changes without changing video quality. The level of noise tolerance can be adjusted. For details, see *Video Noise Solutions* later in this chapter.

**[Monitor Control]**

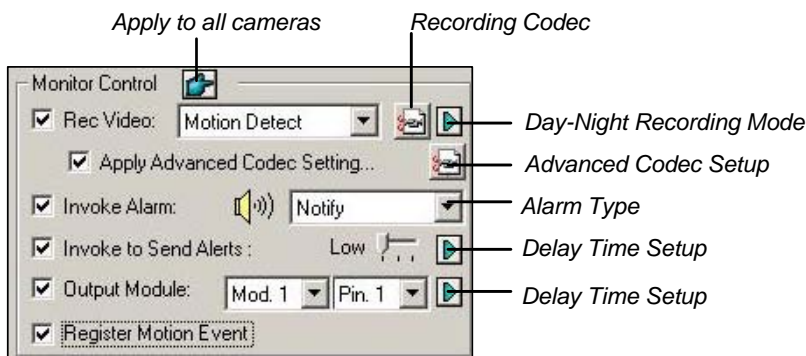

**Figure 1-13 Monitor Control Setup**

- **Rec Video:** Enable the recording function. Use the drop-down list to select the desired recording mode: Motion Detect, Round-the-Clock or Day/Night.  
For details on Day/Night mode, see *Setting Up Day-Night Recording Mode* later in this chapter.
- ⊙ **Recording Codec:** Select the method of recording compression for your video: Geo Mpeg4, Geo Mpeg4-ASP, Geo H264 or Geo H264 V2.  
**GV Mpeg4-ASP:** Provides a smaller compressed file size than Geo Mpeg4. Additionally, it supports a number of advanced settings that allow experienced users to fine tune the encoding process. For details, see *Geo Mpeg4 (ASP) Advanced Settings* later in this chapter.

**Geo H264 and Geo H264 V2:** Provides a much smaller compressed file size than any other available codec yet without compromising the image quality. Compared to Geo H264, Geo H264 V2 provides a smaller compressed file size, but has a lower frame rate and higher CPU usage.

- ☉ **Right-Arrow button:** Click to bring up the Day-Night Recording Mode setup dialog box (Figure 1-14).
- **Apply Advanced Codec Setting:** See *Geo Mpeg4 (ASP) Advanced Settings* later in this chapter. The Advanced Codec Setup button also includes the functions of noise detection and multithreading encoding. See *Noise Detection to Reduce File Size* and *Multithreading Encoding* later in this chapter.
- **Invoke Alarm:** Sends computer alarm (.wav sound file) on motion detection.
- **Invoke to Send Alerts:** Sends an assigned alert (E-Mail/Hotline/SMS) when motion occurs. Use the slider bar to specify the motion duration to invoke the alert. The choices include High (0.5 seconds), Normal (1 second), and Low (1.5 seconds). For example, suppose you choose High. When motion remains for 0.5 seconds, the alert will be sent out.
  - ☉ **Right-Arrow button:** Click to set the delay time to activate assigned alerts.
- **Output Module:** Triggers the specified output pin on motion detection. Use the drop-down list to select an output pin to perform this function.
  - ☉ **Right-Arrow button:** Click to set the delay time to activate the assigned output module.
- **Register Motion Event:** Records motion events to System Log.

---

**Note:** The delay time functions in **Invoke to Send Alerts** and **Output Module** allow you time to deactivate prior alert and output settings. To deactivate these settings, you may stop monitoring or enable the assigned input module set at "**Deactivate notification when selected pin ON**" in Figure 2-9, in Chapter 2.

---

**[Video Resolution]** Allows you to adjust video characteristics such as brightness, contrast, saturation, and hue.

## Setting Up Day - Night Recording Mode

Day-Night Recording allows you to set up different recording modes for different time frames of the day. Each day can be divided to 4 time frames, each represented by 1 Span. You can set up a different frame rate, recording quality, motion sensitivity and noise detection level for each time frame.

1. Click the **Day-Night Recording Mode** button in Figure 1-13, and this dialog box appears.

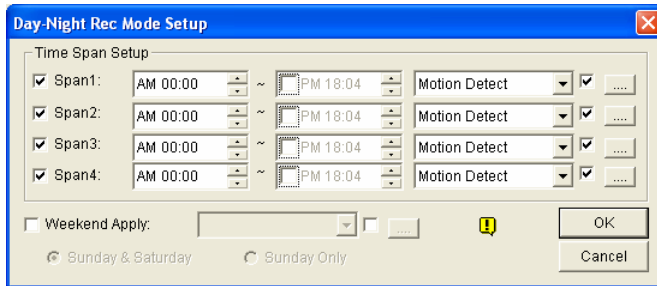

**Figure 1-14**

2. Enable **Span1** and specify the Start time in the first time field; select the check box in the second time field and specify the End time.
3. Use the drop-down list to select **Motion Detect** or **Round-the-Clock** to be the recording mode for the Span 1.
4. Select the check box and click the [...] button to adjust recording quality, motion sensitivity and noise detection level for Span 1.
5. Repeat above steps to set up multiple spans if required.
6. If you do not wish to apply your settings to the weekends, enable the **Weekend Apply** option and select recording mode for the weekend. Use the radio button at the bottom to define whether your weekend includes Sunday and Saturday or Sunday only.
7. Click **OK** to apply the settings.

---

**Note:** If the End time field is disabled, the span will run to the start of the next span.

---

## Geo Mpeg4 (ASP) Advanced Settings

The Geo Mpeg4 (ASP) codec supports a number of advanced settings that allow experienced users to fine tune the encoding process.

In Figure 1-13, check the **Apply Advanced Codec Setting** option, click the  button beside, and then click the **Advanced** tab. This window appears.



**Figure 1-15**

### [Setting]

- **Setting:** Click the drop-down list to select **High speed**, **Recommend**, or **High compression rate** for default configurations. Or, select **User-defined** to define encoding settings yourself.
- **Subpixel precision:** Click the drop-down list to select Full, Half or Quarter pixel.
  - Full pixel:** Fastest compression speed, medium compression rate, and normal image quality.
  - Half pixel:** Fast compression speed, high compression rate, and better image quality.
  - Quarter pixel:** Slow compression speed, highest compression rate, and better image quality.
- **Quantizer:** Raising the value will improve compression speed and dramatically increase compression rate, but reduce image quality.
- **Inter-frame threshold:** Raising the value will improve compression speed and rate, but reduce image quality slightly.



- **Max. keyframe interval:** Raising the value will extend the duration between key frames and increase compression rate, but reduce image quality slightly. Compression speed remains the same.

#### [Evaluation]

- **Encode size:** Click to calculate the encoding size based on your encoding settings (see [Setting] above) and assigned video clip (select **PTZ dome** or **street** from the drop-down list). Click the **Stop** tab to stop the evaluation.
- **Encode speed:** Click to calculate the frame rate based on the encoding settings (see [Setting] above) and assigned video clip (select **PTZ dome** or **street** from the drop-down list).

## Multithreading Encoding

The multithreading encoding feature is designed to speed up video encoding, thus achieving maximum CPU efficiency and frame rate. The performance speedup from multithreading encoding is most obvious when the multi-processor computer is in use.

1. Click the **Configure** button (No. 14, Figure 1-2), point to **General Setting**, and select **System Configure**. On the System Configure dialog box, click the **Camera Record Setting** tab.
2. Check **Apply Advanced Codec Setting**, and click . This dialog box appears.

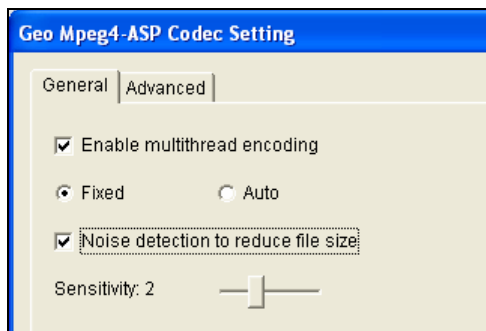
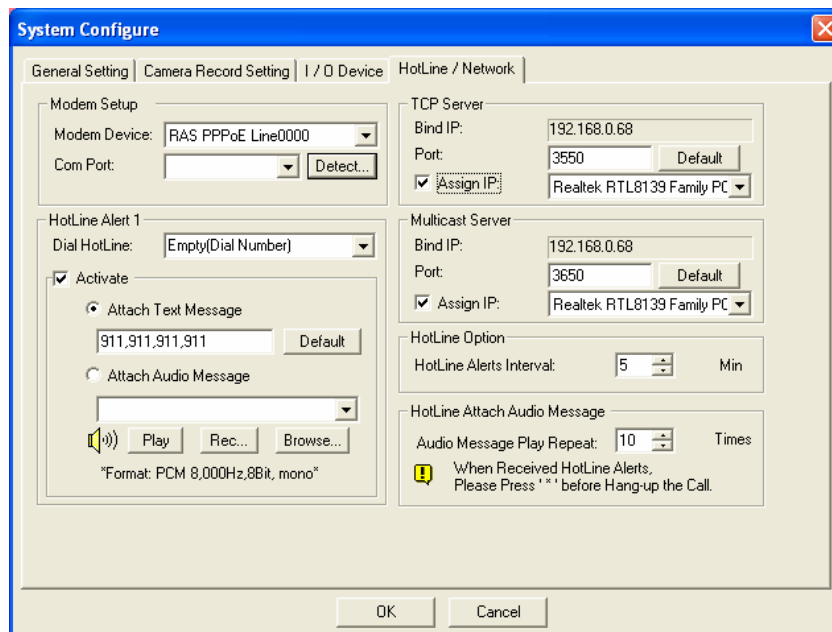

**Figure 1-16**

3. Check **Enable multithread encoding**. Select **Fixed** to always enable the multithreading encoding, or **Auto** to enable the multithreading encoding based on CPU efficiency.



## Configuring Hotline/Network Notification



**Figure 1-17**

**[Modem Setup]** If you have installed modem in this PC, select the corresponding device and port, then press **Detect** button to test your modem.

---

**Note:** Internal modems (PCI or ISA) are not recommended.

---

**[HotLine Notice x]** The event can be set to trigger phone calls or pagers, up to three (3) units. A text message may be sent to the pager.

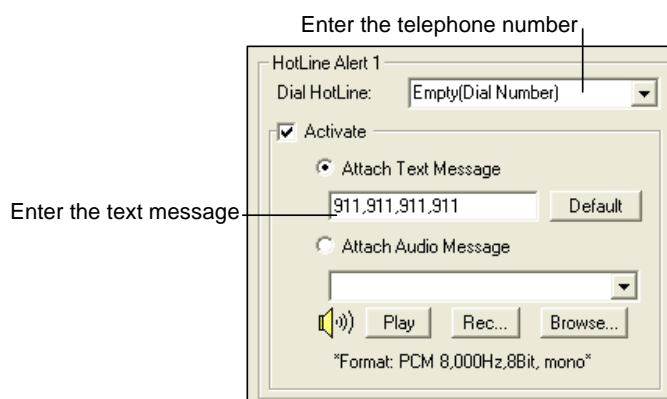

**Figure 1-18**

1. In the Dial HotLine drop-down list, type the telephone or pager number.
2. Click **Activate**.
3. Select **Attach Text Message** and type the text messages to be sent to a pager.

The system allows you to send a custom sound file to telephone. Your computer must have microphones connected to the MIC input of GV-System for this operation. To record a sound file, follow these steps:

1. Click the **Rec** button to bring up the following dialog box:



**Figure 1-19**

2. Click the **Record** button to start recording. Speak the message script clearly to the microphone. Click **Stop** button when it is done.
3. Click the **Play** button to listen to the recording. To save this sound file, click **File**, select **Save as**, and then click the **Change** button. This brings up the Sound Selection dialog box.

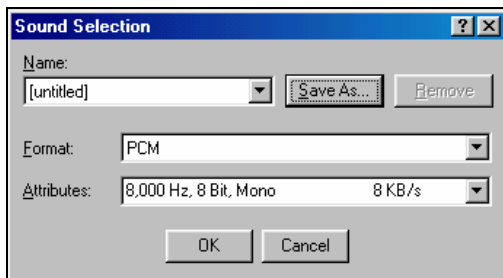

**Figure 1-20**

4. Select **PCM 8,000 Hz, 8-bit Mono**, the only format supported for this feature, and then click **OK**.

To find a sound file, click the **Browse** button to locate the file. Add the path of the file to the field, and the file will be sent with the telephone calls.

**[TCP Server]** Allows you to setup TCP server. Select **Assign IP** and use the drop-down list to select the network card. Your IP address will be displayed in Bind IP. The default port number for TCP server is 3550; you may assign different port by entering the port number in the Port field.

**[Multicast Server]** Allows you to setup the Multicast server; its operation is similar to the TCP server setup described above. The default port number for Multicast server is 3650.

---

**Note:** GV-System automatically checks the dynamic IP of your PC every one minute. This ensures connection of remote applications, including Remote View, IP Multicast, WebCam, and Remote Playback.

---

**[HotLine Option]** If motion persists, decides how often, specified in minutes, the system should send a notification to you before the motion ends.

**[HotLine Attach Audio Message]** Specify how many times to repeat the audio message when a telephone call is made to you.

## Selecting Screen Layout

This feature gives you the option of screen layout for the 8, 12 and 16 screen divisions.

1. Click the **Configure** button (No.14, Figure 1-2), point to **General Setting**, and then select **System Configure**. The System Configure window appears.
2. In the Startup section, click the **Arrow** button next to the Panel Resolution item to call up the following window. The left mode is the default layout; the right is the enhanced layout.

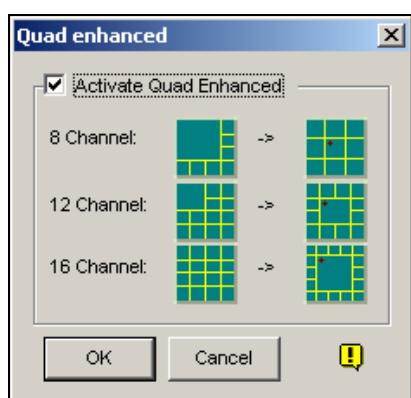

**Figure 1-21**

3. For the enhanced layout, click the **Activate Quad Enhanced** option, and click **OK**.
4. Restart the GV-System to apply it.

---

### Note:

- When the enhanced screen layout is applied, the camera 1 view will show on the central screen; when the popup feature is enabled, the pop-up view will show on the central; when the camera scan feature is enabled, the scanned view will show on the central.
  - If you are using the DSP card, GV-System won't support the enhanced screen layout.
-

## Launching GV-System from System Tray

The feature lets GV-System appear in the system tray when you launch Windows, instead of displaying the system login window. To enable the feature, follow these steps:

1. Click the **Configure** button (No.14, Figure 1-2), point to **General Setting**, and then select **System Configure**. The System Configure window appears.
2. In the Startup section, click the **Arrow** button next to the Startup Auto Login item to display the following window.



**Figure 1-22**

3. Check the **Startup Silently Hide into System Status Bar** option, and then click **OK** to close the window.
4. Restart the GV-System. You will see the following icon shown on the system tray.

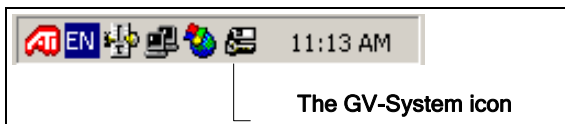

**Figure 1-23**

## Camera / Audio Install

Click the **Configure** button (No.14, Figure 1-2), point to **General Setting**, and select **Camera / Audio Install** to bring up the following dialog box:

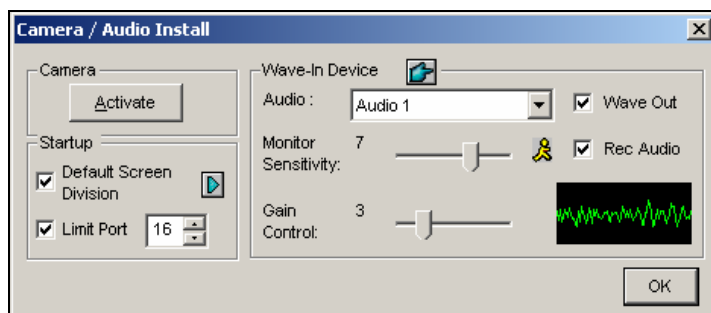

**Figure 1-24**

**[Camera]** Click the **Activate** button and specify the cameras to be viewed by default. Clearing the selection of Cameras from viewing does not affect the cameras being recording.

**[Startup]** Configure the startup camera screens and screen divisions.

- **Default Screen Division:** To select the desired screen divisions at startup, check the option and click the right arrow button.
- **Limit Port:** To restrict camera screens at startup, check the option and select desired port numbers. This function will take effect at next system startup.

**[Wave-in Device]** Adjust audio devices to record and listen to live sound.

- **Audio:** Choose to set up an audio channel from the drop-down list.
- **Monitor Sensitivity:** Adjusts sensitivity of the audio that will be detected. The higher the value, the more sensitive it is to the surrounding sound.
- **Gain Control:** Increases or decreases the gain of the microphone.
- **Wave Out:** Select to listen to live audio at the server PC.
- **Rec Audio:** Enable to activate the audio recording function.

## Setting Up Auto Reboot

The Auto Reboot feature restarts your Windows at a scheduled time. Click the **Configure** button (No.14, Figure 1-2), point to **General Setting**, and then select **Auto Reboot Setup** from the menu to bring up this dialog box.

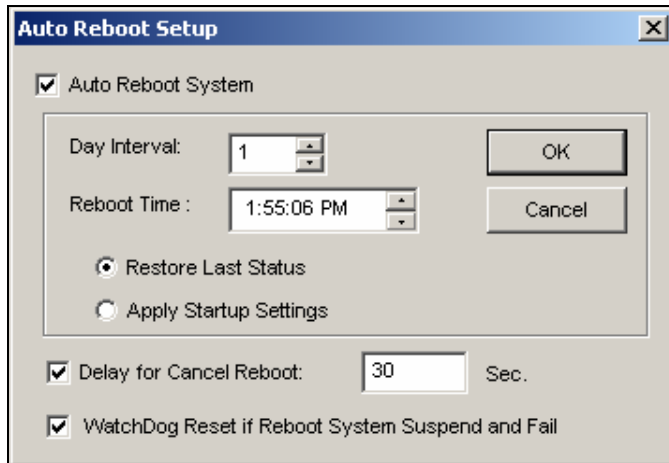

**Figure 1-25**

### [Auto Reboot System]

Enables the setup for reboot time. Specify how often (from 1 to 14 days) at the Day Interval selection field, and when the Windows should reboot at the Reboot Time.

- **Restore Last Status:** The system will resume the last operation after rebooting, e.g. camera recording.
- **Apply Startup Settings:** The system will apply your Startup settings in the System Configure window after rebooting.

**[Delay for Cancel Reboot]** When the item is checked, a warning message will appear and count down your specified time before the reboot schedule begins. Clicking the **Cancel** button on the prompt will cancel the rebooting.

### [WatchDog Reset if Reboot System Suspend and Fail]

Prior to Reboot Time, if GV-System finds any abnormal Windows operation that may hinder the Auto Reboot, GV-System will instruct a hardware reboot of Windows. The feature is available only in GV-600, GV-650, GV-800, GV-1120, GV-1240, GV-1480, GV-2004 and GV-2008.

---

**Note:** GV-System must already be added to Windows Startup menu; only so will the Windows automatically restart GV-System after a reboot. Also, make sure you've correctly connected a GV video capture card to your motherboard for the hardware watchdog feature.

---

## Logging System Activities into System Log

GV-System can monitor security events by recording the login and logout of system resources. No events will be recorded to the System Log until you activate the desired event logs. To activate the log, click the **Configure** button (No.14, Figure 1-2), point to **General Setting**, and then select **System Log Setting** to display the following dialog box.

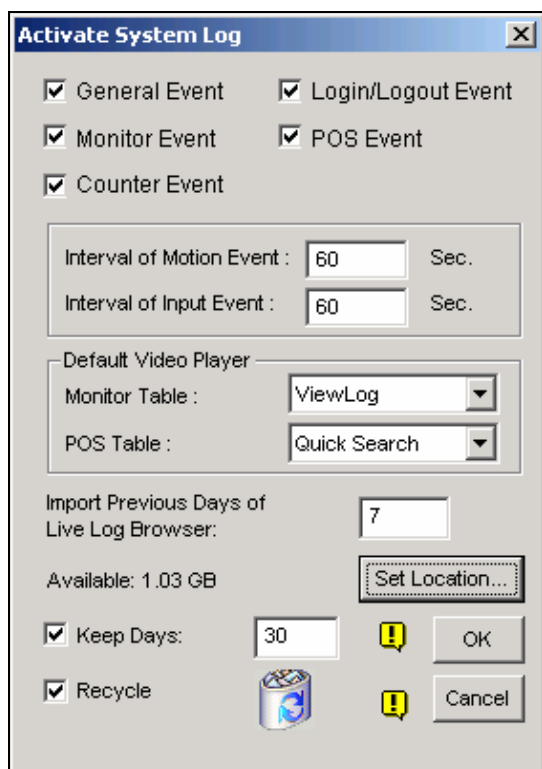

**Figure 1-26**

- **General Event:** Record system startup/exit, network server start/stop, and recording start/stop.
- **Login/Logout Event:** Record local user login/logout GV-System and WebCam Server.
- **Monitor Event:** Record motion-triggered and I/O-triggered events. For this feature to work, you must check both the **Register Motion Event** option in Figure 1-13 and the **Register Input Event** option in Figure 2-1 in Chapter 2.
- **POS Event:** Record POS transaction data.
- **Counter Event:** Record counting results.
- **Interval of Motion Event:** Specify the log interval between motion-triggered events. This setting could prevent the System Log growing too big when trying to log all events under a motion-intensive surveillance area.
- **Interval of Input Event:** Specify the log interval between I/O-triggered events.

**[Default Video Player]**

- **Monitor Table:** Specify the playback software for playing back monitor events. [For details on each playback application, see Chapter 4.](#)
- **POS Table:** Specify the playback software for playing back POS events.

**[Import Previous Days of Live Log Browser]** Specify how many days of data to be loaded to the System Log.

- **Set Location:** Click the **Set Location** button to specify a storage path. The available free space will be displayed in left hand side.
- **Keep Days:** Set the number of days to keep logs.
- **Recycle:** Enable the system to delete old log files to make space for new files when the HDD free space is below 500MB.

To view and learn more about System Log, see *System Log* later in this chapter.



## Popping Up a Camera Window on Motion Detection

Using this feature, you may view the pop-up camera at the moment when event occurs. To set up, click the **Configure** button (No.14, Figure 1-2), point to **Video Analysis**, and then select **Camera Popup Setting**. This brings up the following Camera Popup Setting dialog box.

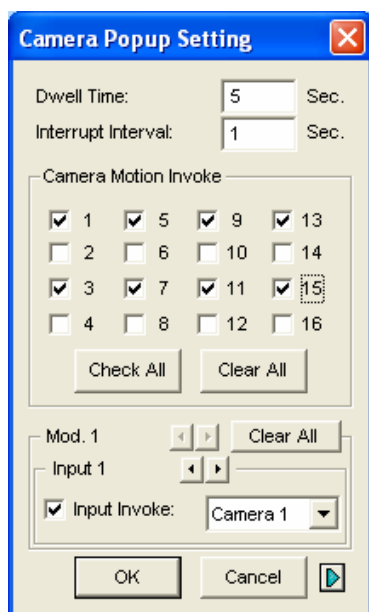

**Figure 1-27**

- **Dwell Time:** Specify the amount of time a pop-up camera window to remain in the foreground.
- **Interrupt Interval:** This feature is useful when more than one camera is set for pop-up notification. If cameras are all activated at the same time, specify the interrupt interval here would allow you to set the amount of time between camera pop-ups.
- **Camera Motion Invoke:** Choose which camera you wish to have auto pop-up on motion-triggered event.
- **Input Invoke:** Use this function to have an I/O device trigger the auto pop-up.
- **The Arrow Button:** The pop-up camera windows appear on the screen when events occur. If the DSP Spot Monitor function is enabled, you can select if pop-up camera windows appear on the system screen, spot monitor or both. For details on DSP Spot Monitor Controller, see *DSP Spot Monitor Controller* later in this chapter.

---

**Note:** For Camera Motion Invoke, you may use the **Mask Filter** function on the Camera Record Setting tab (Figure 1-9) to adjust the area of activation.

---

## Different Text Alignment for Each Channel

You can align text overlay, photo overlay and camera/time stamps to different positions for each channel. In addition, you can even change the alignment of text and photograph while the monitoring of POS or access control keeps on.

To access this feature, click the **Configure** button (No.14, Figure 1-2), point to **General Setting**, and then select **Text Overlay Setting** to display the Text Overlay Setting dialog box, and click one **Camera** tab to define various alignments.

For details on the text overlay settings, see *Superimposing POS Data onto Camera Screen* in Chapter 3.

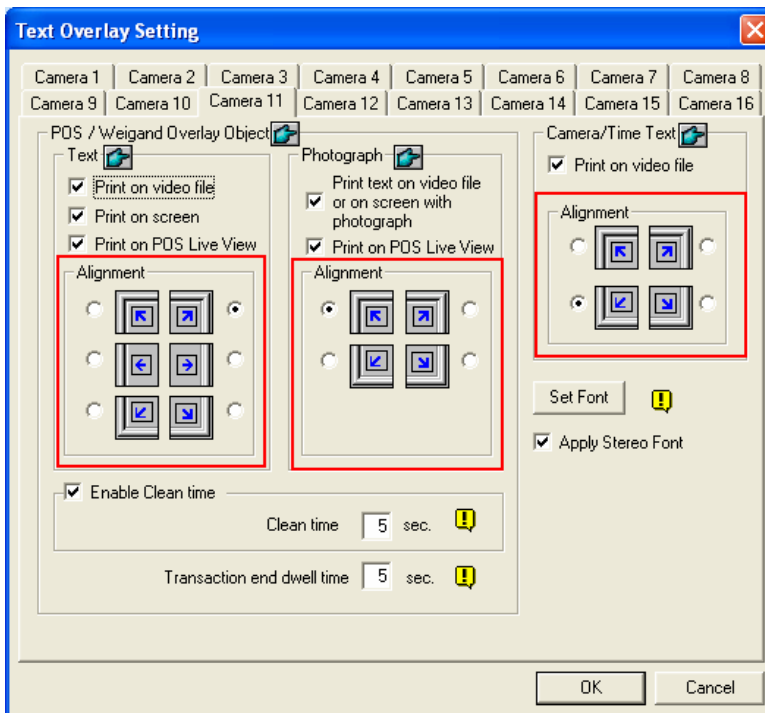

**Figure 1-28**

## Configuring Object Counting

Object counting in GV-System provides bi-directional counting of objects under the surveillance area. When defined, it could count any objects, such as people, vehicles, animals, etc.

1. Click the **Configure** button (No.14, Figure 1-2), point to **Video Analysis**, and then select **Counter Application Setting**. This dialog box appears.

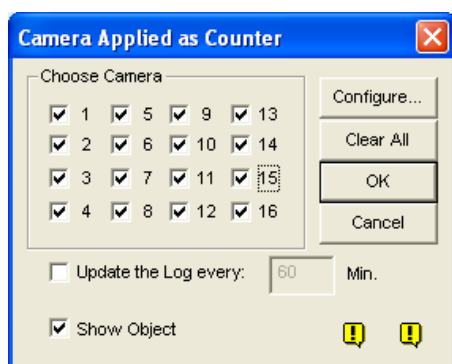

Figure 1-29

2. Select the desired cameras for the counter application.
3. Select **Show Object** in the lower of the window to put a rectangle around the object being tracked.
4. Click the **Configure** tab to open the Setup dialog box.

### [Counter]

To define the counter to count target objects, click the **Counter** tab.

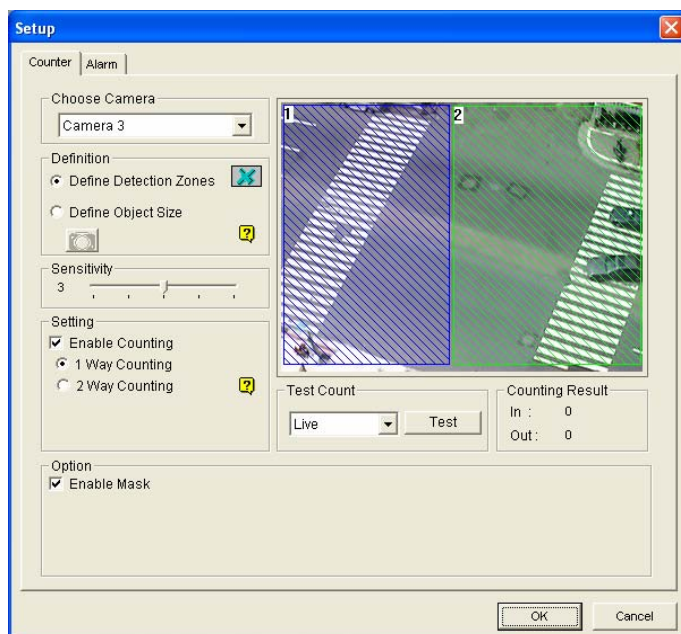
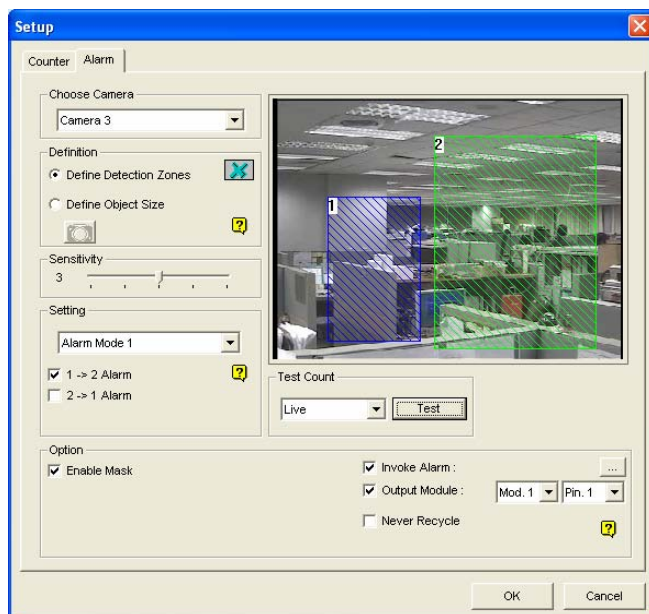

Figure 1-30

1. In the Choose Camera section, select a camera from the drop-down list for setup.
2. In the Definition section, there are two options:
  - **Set Detection Zones:** Use the mouse to outline detection regions on the video image. Number 1 is for region 1; number 2 for region 2. Defining multiple regions 1 and 2 is practicable. Clicking the **delete (blue X icon)** button will clear all defined regions.
  - **Define Object Sizes:** Use the mouse to outline a region matching the normal size of the targeted object. If the video is playing, first click the **Snapshot** button to freeze the image before defining.
3. In the Sensitivity section, adjust the detection sensitivity. The higher the value the more sensitive the system to motion.
4. In the Setting section, select **Enable Counting** and select how you want to count the objects.
  - **1 Way Counting:** When an object appears in region 1 and then enters into region 2, it will be counted as 1 in.
  - **2 Way Counting:** When an object appears in region 1 and then enters into region 2, it will be counted as 1 in, and when an object appears in region 2 and then enters region 1 it will be counted as 1 out.
5. In the Option section, select how you want to highlight the detected object. If **Enable Mask** is enabled, masks will be displayed on the detection regions.
6. To test your settings of counting, select **Live** from the drop-down list, and then click the **Test** button. Notice how the number changes in the Counting Result section when objects pass through the detection regions. There are three options in the drop-down list. **Live** tests your current settings; **Door Demo** and **Traffic Demo** are pre-recorded events, showing how the application counts objects in actual DVR examples.

**[Alarm]**

To set up the detection alarm, click the **Alarm** tab.



**Figure 1-31**

1. In the Choose Camera section, select a camera from the drop-down list for setup.
2. Define the detection regions and object size. See Step 2 in **[Counter]** section above.
3. In the Setting section, there are two kinds of alarm modes:
  - **Alarm Mode 1:** The detected object slightly crosses the border of the alarm region it is about to enter.
  - **Alarm Mode 2:** The detected object is fully inside the alarm region it just enters.
 After you select the alarm mode, select how you want the alarm to be triggered.
  - **1→2 Alarm:** When an object enters from region 1 to region 2, the event will be recorded as “Intruder” in System Log for later retrieval.
  - **2→1 Alarm:** When an object enters from the defined region 2 to region 1, the event will be recorded as “Intruder” in System Log for later retrieval.
4. In the Option section, you can mask the detection regions, select alarms and deal with alarm-triggered events.
  - **Enable Mask:** Mask the defined detection regions.
  - **Invoke Alarm:** Activate the computer noise alarm when an object enters a defined region. Click the button next to the item to assign a .wav sound file.
  - **Output Module:** Enable an installed output device when an object enters a defined region. Assign the output module and pin number.
  - **Never Recycle:** When the item is checked, the alarm-triggered events won't be recycled even when disk space is full.
5. To test your alarm settings, click the **Test** button.

## Mapping PTZ Cameras

This option assigns a PTZ camera to its corresponding camera channel for either the local or the remote applications.

- For local applications, see *Auto Switching PTZ Control Panels* later in this chapter.
- For remote applications, this option will let you control PTZ cameras through the WebCam or Center V2 server.

1. Click the **Configure** button (No.14, Figure 1-2), point to **Accessories**, and select **Camera Mapping PTZ Dome**. This dialog box appears.

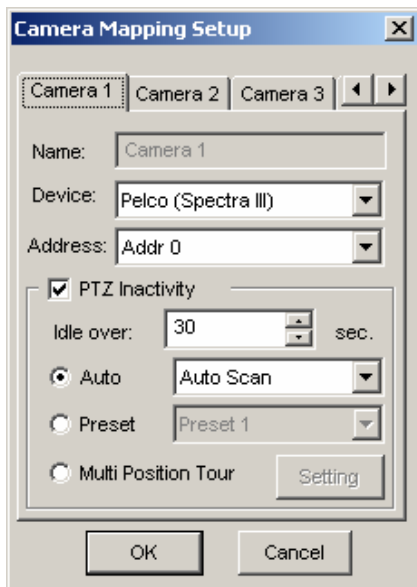

**Figure 1-32** Camera Mapping Setup

2. Select a camera channel by using the camera tabs in the upper part.
3. Select the PTZ camera connected to the selected channel from the Device drop down list.
4. If you have two identical PTZ cameras set in the system, you may use the Address drop down list to choose the one with the correct address.
5. Click **OK** to apply the settings.

## PTZ Idle Protection

When the PTZ remains stationary for a certain time, the camera can automatically activate the auto mode, move to the designated preset point or start the preset tour.

1. Click the **Configure** button (No. 14, Figure 1-2), point to **Accessories**, and select **Camera Mapping PTZ Dome**. The Camera Mapping Setup dialog box (Figure 1-32) appears.
2. Select the desired camera from the Device drop-down list, and check **PTZ Inactivity**.
3. Set the idle time after which to start the protection mode.
4. Select **Auto**, **Preset** or **Multi Position Tour** as protection mode.

### Setting Multi Position Tour

You can create a PTZ tour with up to 64 preset points. Note the number of preset points depends on your PTZ capacity.

1. Select **Multi Position Tour** on the Camera Mapping Setup dialog box (Figure 1-32), and click the **Setting** button. This dialog box appears.

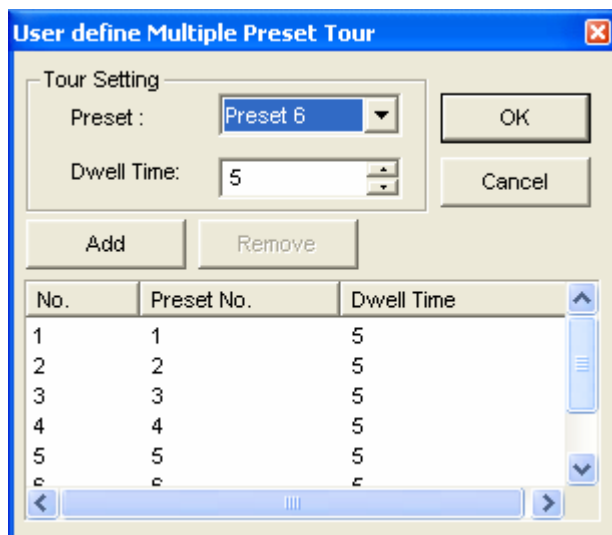
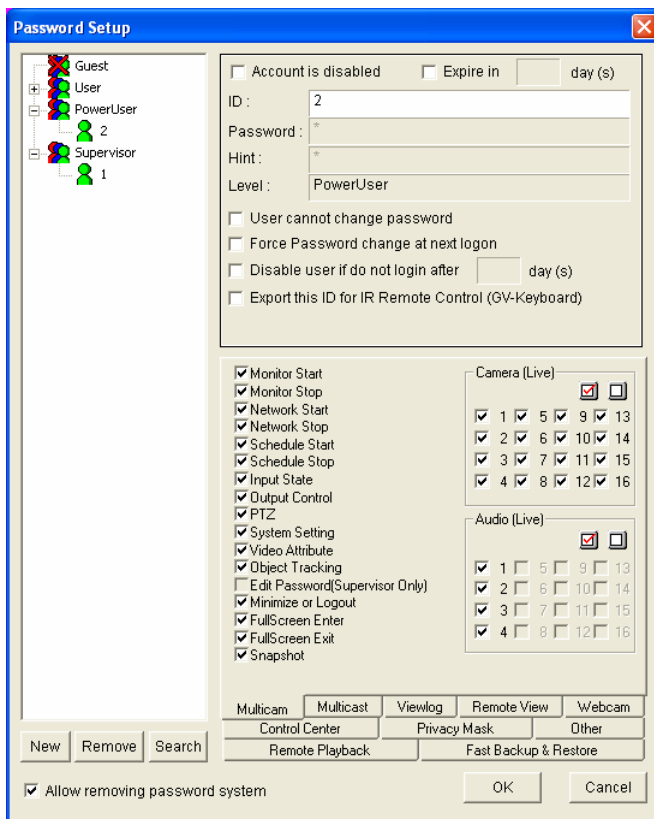

**Figure 1-33**

2. Select a Preset as a start point.
3. Set the Dwell Time that the PTZ will remain in a preset.
4. Click **Add** and repeat Steps 2-3 to build more points in the tour.

## Setting Up Password

The password setup allows you to assign permission and rights to users. You can create up to **1,000** passwords. The system will control and restrict access to system resources based on the permission and rights associated with each user account. Only Supervisor account level is pre-set with the access to the Password Setup function. Click the **Configure** button (No. 14, Figure 1-2), point to **General Setting**, point to **Password Setup**, and then select **Local Account Edit** to display the following window.



**Figure 1-34**

### Adding a new user:

1. Click the **New** button at the lower-left hand corner to bring up the New Account dialog box.

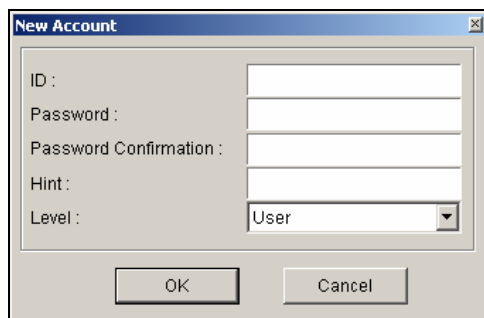

**Figure 1-35**



2. Enter the user's **ID** name and **password**. Re-enter the same password in the Password Confirmation field.
3. Give a **Hint** (optional) that would remind you of the password.
4. Select the user's authorization level: **Supervisor**, **PowerUser**, **User** or **Guest**. By default, users belonging to the Supervisor level have full rights over GV-System settings. PowerUsers have the same permission and rights as Supervisors, except that they cannot edit user information and delete the password system (described later). Users belonging to the User level are restricted to all system settings, and have only limited access to certain functions. Users in the Guest level can only view videos.
5. Click **OK** to add the user.

#### **Editing an exiting user:** (Only supervisors are allowed to do it.)

1. Select a user from the user list to display its properties. Or, right-click on any of the user levels (User, PowerUser, Supervisor), and then select **Find Specific Account** for quick search. A valid password is required to edit a supervisor.
2. Edit the properties as required. Check the **Account Is Disabled** option if you wish to disable this user.

These options you may also find in this dialog box:

- **Expire in xx day(s):** The account will expire and be disabled automatically after a set number of days. The number you set will count down automatically. Specify the number between 1 and 9999.
- **User cannot change password:** The user is not allowed to change the set password.
- **Force Password change at the first logon:** The user must change the password when logging in first time.
- **Disable user if do not login after xx day (s):** When the user does not log in the system after a set number of days, its account will be disabled automatically.
- **Export this ID for Remote Control:** This option allows the export of users IDs for the remote control. When it is checked, you can see the designated ID in the drop-down menu of login. (Note: For the operation of remote control, the password should be restricted for digits.)
- **Allow removing password System:** This option lets users remove the ID and password database from GV-System. To do this, select this option (only Supervisor level users can make the selection), and then find and click **PassUnInstall** in the system folder. A message prompts to you for confirmation. Click **Yes** to remove the entire ID and password from GV-System.

---

**Note:** If the **Allow Removing Password System** option is not selected, the loss of passwords will require the reinstallation of Windows and the reset of passwords.

---

## Changing password when logging in the GV-System

1. When you log in the GV-System, click the **Change Password** button in the Login dialog box. The Change Password dialog box appears.

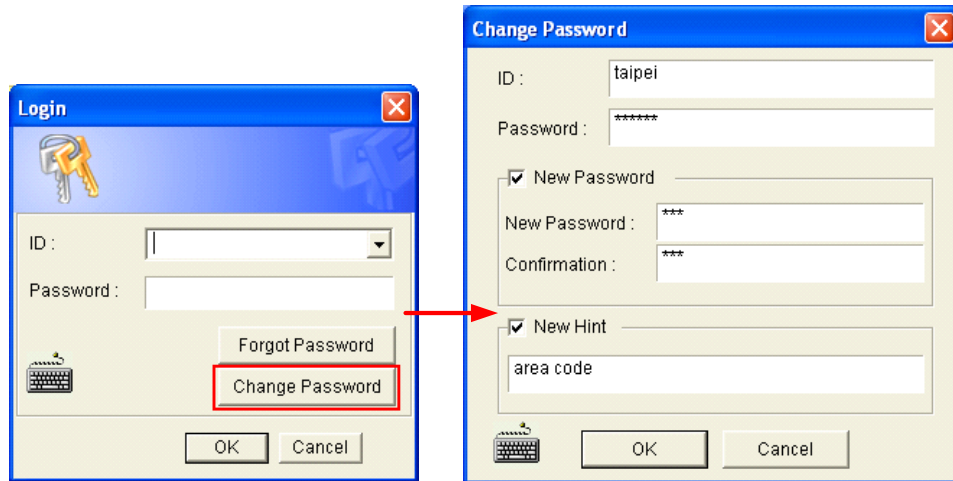

**Figure 1-36**

2. Type the new password information, and click **OK** to save the changes.

---

**Note:** If the user is not given the right to change password, the message *Change Password/Hint False* will be displayed.

---

## Sending Alerts thru E-mail Accounts

You can send E-mail alerts with attached images when events occur. The events triggering the E-mail alerts include: Motion Detection, I/O Trigger, Scene Change, Intruder Event, Missing Object, Unattended Object, POS Loss Prevention and etc.

You may first set up your server to handle the sending of alerts. Follow these steps to set up an E-mail account:

1. Click the **Configure** button (No.14, Figure 1-2), point to **General Setting**, and then select **E-Mail Setup**. This dialog box appears.

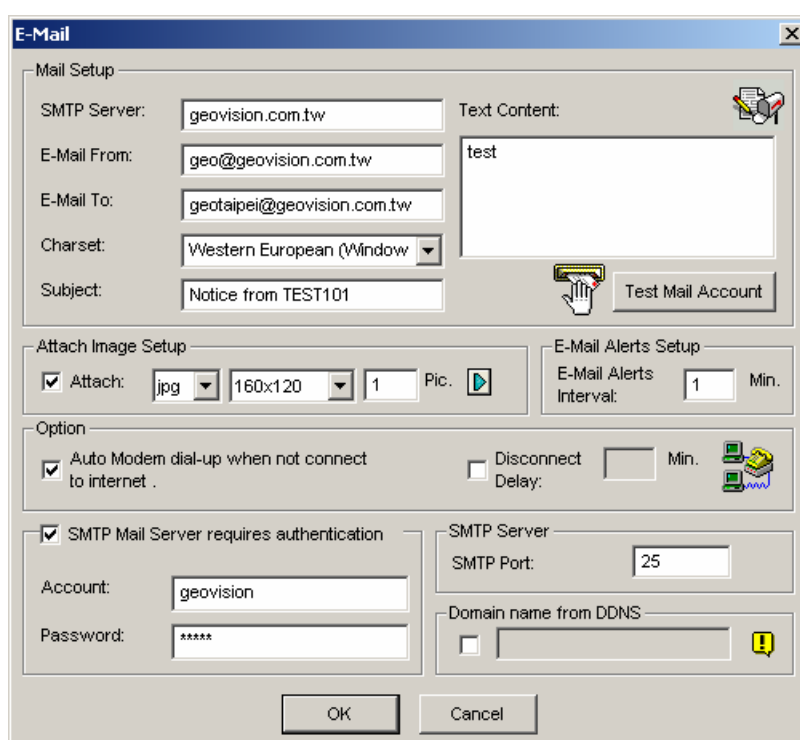

**Figure 1-37**

2. In the Mail Setup section, set up following fields:
  - **SMTP Sever:** Enter your mail server name.
  - **E-Mail From:** Enter the reply E-mail address (optional).
  - **E-Mail To:** Enter the E-mail address you want to send alerts to.
  - **Charset:** Select the character-set to be used when sending mail via the system.
  - **Subject:** Enter a subject that would come with the alert message.

3. You have the option to attach an image with the alert when sending mail. Click to enable the option. Select image format from the drop-down list, and the image size.
4. In the **Pic.** Field, enter how many snapshots (max. 6) you wish to receive in an event.
5. Press the Arrow button if you wish to tag the snapshot with Time/Date, Camera number, and Location name. Select **Transparent** makes the tag background transparent, and **Color Box** is for you to choose your text color.
6. Click the **Test Mail Account** button to test if E-mail function is working correctly. You may click **OK** here or go on to set up with following options:

**[Email-Alerts Setup]** The GV-System can continuously send E-mails to you when events occur. You may specify the interval between E-mails. The default interval is 5 minutes (configurable from 0 to 60 minutes); therefore if motion lasts for more than 15 minutes it means you will receive 3 E-mails. If motion lasts for less than 5 minutes, then you will receive one E-mail only.

**[Option]** Select **Auto Modem dial-up** to dial-up automatically when the system is instructed to send E-mail alerts. The **Disconnect Delay** disconnects the system from Internet after the set number of minute(s) (from 0 to 30 minutes).

**[SMTP Mail Server requires authentication]** If the SMTP mail server needs authentication, select this item and enter your account name and password.

**[SMTP Server]** Keep the default port 25 or modify it to match that of SMTP Server.

**[Domain Name from DDNS]** Enter a domain name from DDNS server. The email alert will be sent containing Webcam Server information and an URL link for remote playback. For this function, you must enable **WebCam Server**.

For related settings, see *Send Alert Approach*, *Invoke to Send Alerts* and *Send Event Alerts* earlier this chapter.

## Choosing Video Source

Video Source sets the video standard of your system: NTSC or PAL. Click the **Configure** button (No.14, Figure 1-2), point to **A/V Setting**, and then select **Video Source** to display the following dialog box.

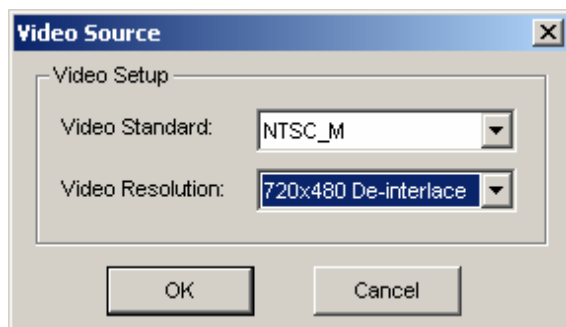

Figure 1-38

**[Video Setup]** Determines a video standard for your system.

- **Video Standard:** Select a video standard used in your country.
- **Video Resolution:** Consider your priority in image quality or CPU usage before making a selection.
  - For NTSC, the image quality and CPU usage from the highest to the lowest is: 720 x 480, 720 x 480 De-interlace, 640 x 480, 640 x 480 De-interlace, 360 x 240, 320 x 240.
  - For PAL, the image quality and CPU usage from the highest to the lowest is: 720 x 576, 720 x 576 De-interlace, 640 x 480, 640 x 480 De-interlace, 360 x 288, 320 x 240.

## Adjusting Video Attributes

This feature lets you adjust video attributes to get the best picture. Click the **Configure** button (No.14, Figure 1-2), point to **A/V Setting**, and select **Video Attributes** to have two selections: **Standard** and **Advanced**.

### Standard Video Attributes

Adjust image quality by moving the slide bars to the desired values. Click **Default** to apply default values. Click the **left and right arrow** buttons to select a desired camera for setup. Or, click the **finger** button to apply the displayed settings to all cameras.

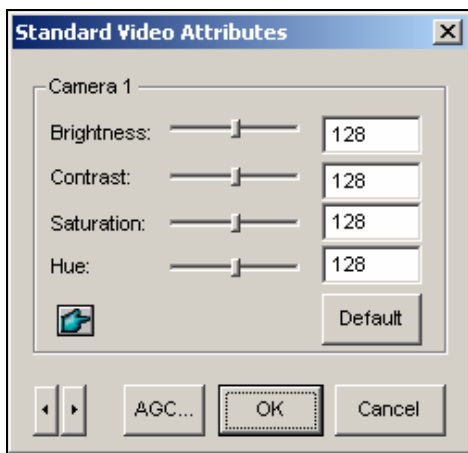

**Figure 1-39**

**AGC (Auto Gain Control):** Adjusting AGC helps boost weak video signals or reduce strong video signals, and gives optimized image quality. The adjustment could be done manually or automatically. When a video signal is weak, for example, due to distance, adjusting the brightness or contrast of the video source will NOT help the situation. Adjust AGC and see the difference. (Depending on the model purchased, this feature may or may not be available.)

In the Auto Gain Control window, click **Auto** for auto adjustment, click **Default** to apply default values, or click **Apply** to apply the displayed settings. The default value is set to 1.15V (115), but you may move the slider bar to adjust between 0.3V (30) or 2.5V (250).

## Advanced Video Attributes

This feature lets you know the image size after quality and image adjustment.

### [Multicam]



**Figure 1-40**

- **Camera drop-down list:** Select a camera channel for the application.
- **Codec Selection:** Select a desired type of compression.
- **Image Adjustment (Brightness, Contrast, Saturation, Hue):** Move the slide bars to adjust image attributes. Click the **finger** button to apply the displayed values to all cameras.
- **Recording Quality:** Move the slide bar to increase or decrease the picture quality. Click the **finger** button to apply the selected quality to all cameras.
- **Image Size:** **Keyframe** indicates the compressed file size while **Frame** shows the partly compressed file size after quality and image adjustment.

---

**Note:** The smaller image size means higher video compression and smaller file size, thus extending the recording capacity.

---

## [WebCam, Center V2, Control Center]

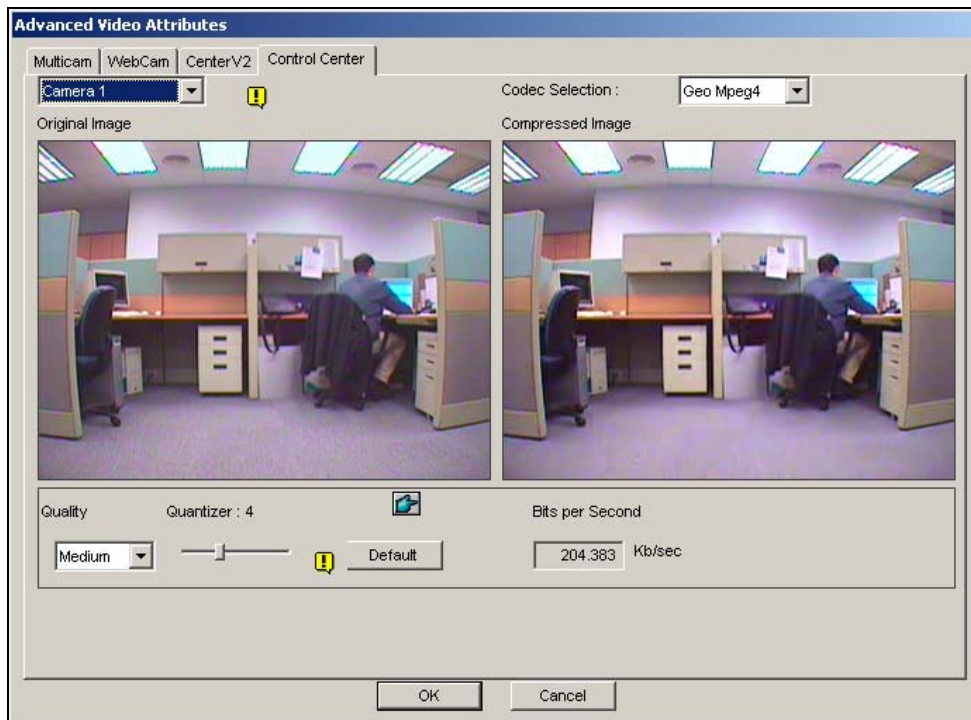

**Figure 1-41**

- **Quantizer:** The bigger the Quantizer, the poorer the image quality.
- **Quality:** The default Quantizer for High is 2, for Medium is 4 and for Low is 6. The adjustment rules between Quantizer and Quality is: Quantizer for High < Quantizer for Medium < Quantizer for Low.
- **Bits per second:** Indicates the data transmission speed after quality adjustment.



## Switching to Full-Screen View

For full-screen display, first select the **Enable Directdraw Overlay** option (Figure 1-3). Click the **Configure** button (No. 14, Figure 1-2), point to **A/V Setting**, and then select **Full Screen** to switch to full screen. Right-click on the full screen and select **Toggle Full Screen** to switch back to normal view screen. Alternatively, press **[F]** on the keyboard to toggle between full-screen view and normal screen view.

## Listening to Live Audio

Click the **Configure** button (No. 14, Figure 1-2), point to **A/V Setting**, select **Wave Out**, and then select the audio channel you wish to listen to.

By default, audio channel 1 is set to be background sounds even when you switch between video channels. To change background sounds, select the desired audio channel and select **Disable Wave-Out Audio Switch**. The selected audio channel will always be in the background.

## Stopping Video Lost Watchdog

When the video signal is weak, the software watchdog will try to recover the lost video by restarting the system and even rebooting the computer. If the video lost watchdog feature is not required, you have the option to disable it.

To disable this feature, click the **Configure** button (No. 14, Figure 1-2) , point to **Tools**, select **Video Signal Diagnostic**, and select **Disable Video Signal Weak Watchdog**.

---

**Note:** This option is only available for GV-600, 650, and 800 Cards.

---

## Deactivating Video Lost Beep

To stop a beep noise when any of videos lost, click the **Configure** button (No. 14, Figure 1-2), point to **Tools**, select **Video Signal Diagnostic**, and select **Disable Video Lost Beep**.

## Start/Stop Monitoring

Click the **Monitor** button and select to start or stop all or individual camera monitoring. Camera Name in the upper left corner of the view screen changes from yellow to red color when motion is detected. (Blinking represents the camera is detecting motion). **[F7]** is the shortcut key of this operation.

**Tip:** To take a snapshot of the current frame, click the Camera Name and select **SnapShot** to open the Save As dialog box, shown as below. Save and tag the frame with Time/Date, Camera number, and Location name. Select **Transparent** if you want to make the tag background transparent, and select **Color Box** to choose your text color.

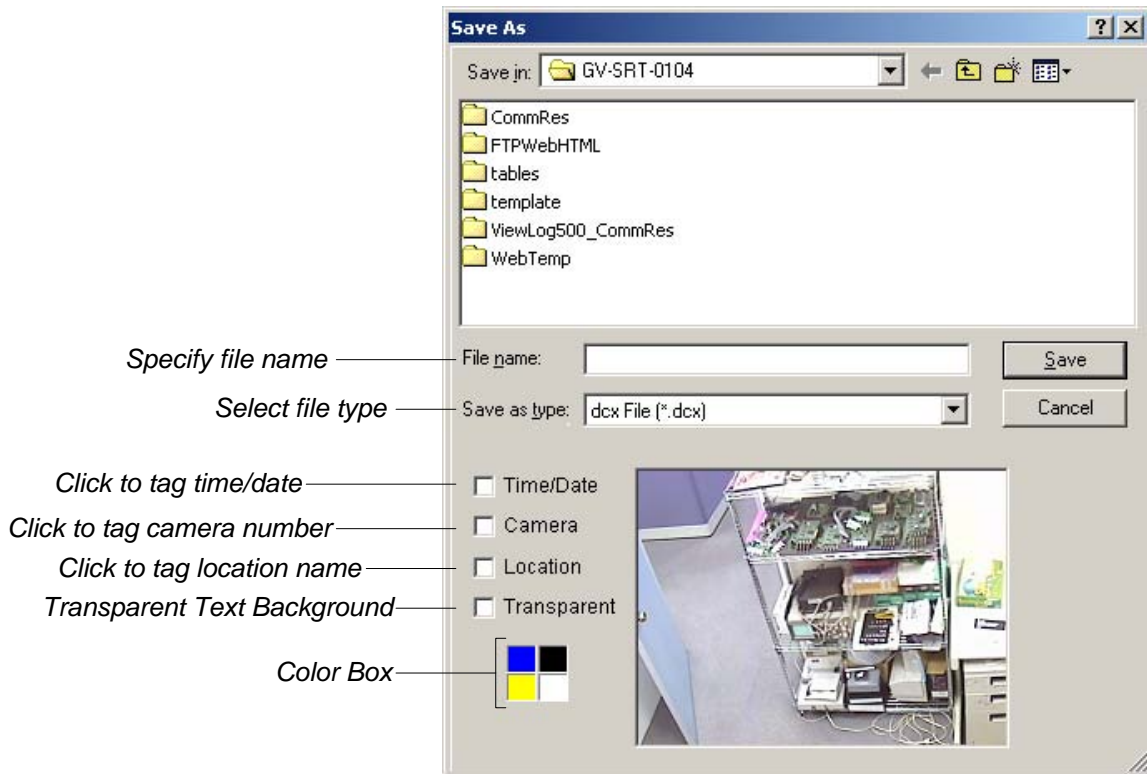

**Figure 1-42**

## Playing Back Video Files

The **ViewLog** button (No. 13, Figure 1-2) is used for playing back video and audio files. For details, see Chapter 4.

### Instant Playback

You can instantly open ViewLog to trace the event(s) of a certain time length without interrupting the morning.

- To instantly play back the event(s) of one single channel, click on the **Camera Name**, and then select the time length.
- To instantly play back the events of all channels, click on the **ViewLog** button (No. 13, Figure 1-2), select **Instant Play**, and then select the time length.

Time length choices include 10 seconds, 30 seconds, 1 minute and 5 minutes.

## System Log

System Log displays detailed information about the GV-System and remote operation. This information is being saved in a database Access format. To view the System Log, click the **ViewLog** button (No. 13, Figure 1-2), and then select **System Log** from the menu. This brings up the Live Log Browser as shown below. The Log Browser viewer displays five types of event information. Use the control tab to switch among them.

Clicking the  icon on the upper left corner brings up the Advanced Log Browser. For details on the Advanced Log Browser, see *Searching and Playing Back Motion, Alarm, and POS Event* in Chapter 4.

**[Monitor]** Displays information pertaining to motion and I/O events. Double-clicking the log list will allow you to view related video in ViewLog or Quick Search (depending on the video player you selected in the Activate System Log dialog box. See Figure 1-26).

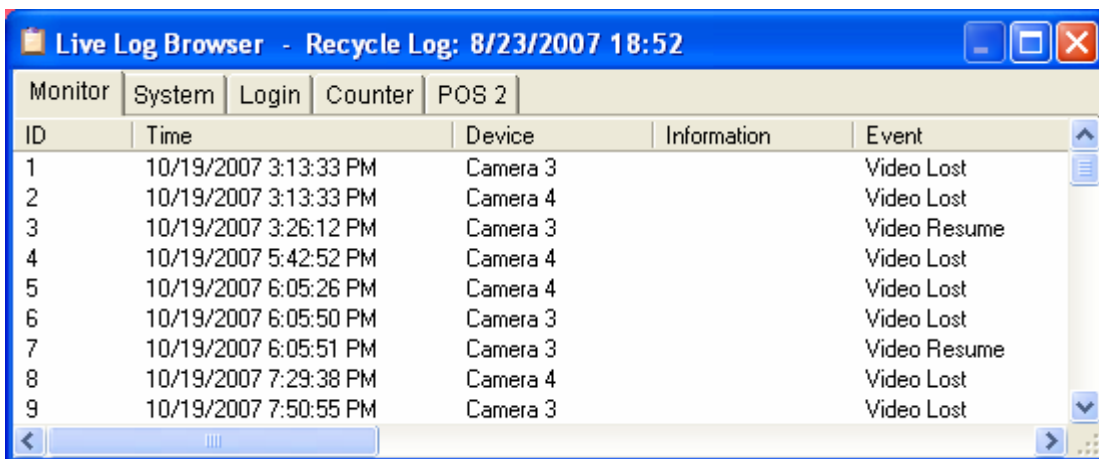

The screenshot shows a window titled "Live Log Browser - Recycle Log: 8/23/2007 18:52". It contains a tabbed interface with "Monitor" selected. Below the tabs is a table with the following data:

ID	Time	Device	Information	Event
1	10/19/2007 3:13:33 PM	Camera 3		Video Lost
2	10/19/2007 3:13:33 PM	Camera 4		Video Lost
3	10/19/2007 3:26:12 PM	Camera 3		Video Resume
4	10/19/2007 5:42:52 PM	Camera 4		Video Lost
5	10/19/2007 6:05:26 PM	Camera 4		Video Lost
6	10/19/2007 6:05:50 PM	Camera 3		Video Lost
7	10/19/2007 6:05:51 PM	Camera 3		Video Resume
8	10/19/2007 7:29:38 PM	Camera 4		Video Lost
9	10/19/2007 7:50:55 PM	Camera 3		Video Lost

**Figure 1-43**

**ID:** This column shows the event ID number generated by the system.

**Time:** This column shows the time when a motion or I/O monitor event occurs.

**Device:** This column shows camera ID or I/O device associated with the event.

**Information:** This column shows the I/O module number

**Event:** These event messages mean:

- **Motion:** Appear if motion occurs in the associated camera.
- **Video Lost:** Appears if video lost occurs in the associated camera.
- **Video Resume:** Appears if video resume in the associated camera.
- **Signal On:** Appears if one of the input device connected to the associated I/O module are activated.
- **Signal Off:** Appears if one of the input device connected to the associated I/O module are terminated.

- **I/O error:** Appears if associated I/O module failed.
- **I/O resume:** Appears if associated I/O module resume to action.
- **Missing Object:** Appears if objects miss from a defined camera view.
- **Unattended Object:** Appears if unattended objects show up within a defined camera view.
- **Intruder:** Appears if there are objects entering a defined region.
- **Disk Full:** Appears if storage space is full.
- **Scene Change:** Appears if the associated camera has been physically tampered.
- **Network Shutdown:** Appears if the network connection is closed.
- **Camera Connection Lost:** Appears if the connection to the associated cameras is lost.
- **Camera Connection Resumed:** Appears if the connection to the associated camera is rebuilt.

[System] This function shows which functions are being enabled or disabled in the GV-System.

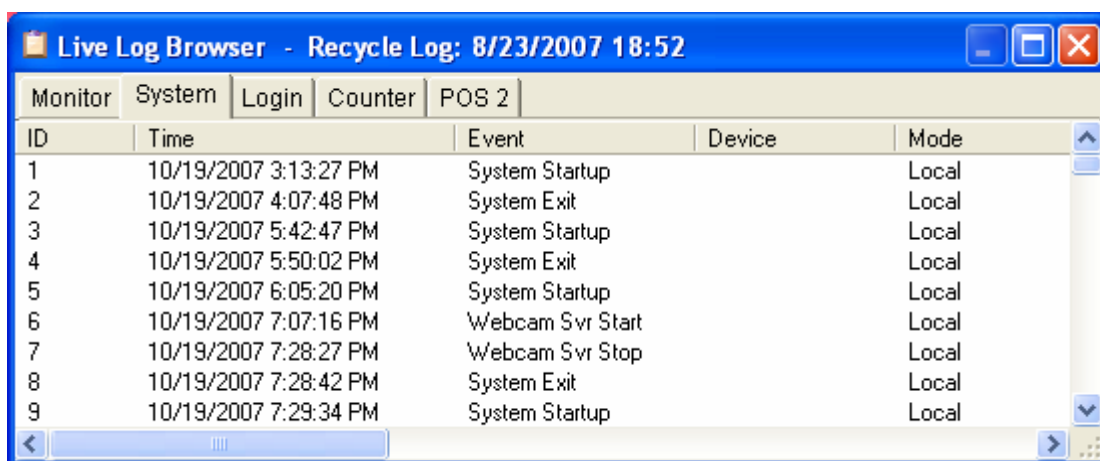

ID	Time	Event	Device	Mode
1	10/19/2007 3:13:27 PM	System Startup		Local
2	10/19/2007 4:07:48 PM	System Exit		Local
3	10/19/2007 5:42:47 PM	System Startup		Local
4	10/19/2007 5:50:02 PM	System Exit		Local
5	10/19/2007 6:05:20 PM	System Startup		Local
6	10/19/2007 7:07:16 PM	Webcam Svr Start		Local
7	10/19/2007 7:28:27 PM	Webcam Svr Stop		Local
8	10/19/2007 7:28:42 PM	System Exit		Local
9	10/19/2007 7:29:34 PM	System Startup		Local

Figure 1-44

**ID:** Displays the event ID number

**Time:** This column shows the time when system event occurs.

**Event:** This column shows the following messages when associated actions are taken.

- **Schedule Start / Stop:** Appears when a user starts or stops the monitoring schedule.
- **Auto Reboot:** Appears when the system performs auto rebooting function.
- **System Start / Exit:** Appears when a user starts or stops GV-System.
- **Start / Stop Monitor All:** Appears when a user starts or stops all cameras' monitoring functions.
- **Start / Stop Monitor:** Appears when a user starts or stops the individual camera's monitoring function. The camera number will appear in Device column.
- **IO Monitor Start / Stop:** Appears when a user starts or stops the individual I/O module's monitoring function. The I/O module number will appear in the Device column.
- **Modem Svr Start / Stop:** Appears when a user starts or stops GV-System's Modem Server.
- **TCP Svr Start / Stop:** Appears when a user starts or stops GV-System's TCP Server.

- **Multicast Svr Start / Stop:** Appears when a user starts or stops Allows connection to IP Multicast (one of the remote application) at system startup.
- **WebCam Svr Start / Stop:** Appears when a user starts or stops WebCam Server.
- **Connect to Center Start / Stop:** Appears when GV-System connects or disconnects with the Security Center.
- **Twin Svr Start / Stop:** Appears when a user starts or stops Twin Server.
- **Connect to Center V2 Start / Stop:** Appears when GV-System logs in or out Center V2.
- **Connect to VSM Start / Stop/Net Down / Net Resume:** Appears when GV-System logs in or out VSM; when the connection of both fails or resumes.
- **Connect to SMS Start / Stop / Net Down / Net Resume:** Appears when GV-System logs in or out the SMS server; when the connection of both fails or resumes.
- **Send Email Alert:** Appears when an e-mail alert is sent out.
- **Send SMS Alert:** Appears when an SMS alert is sent out.
- **Send Hotline Alert:** Appears when a Hotline alert is sent out.
- **Windows Shutdown:** Appears when Windows is closed.
- **Recycle:** Appears when GV-System recycles event files to increase storage space.
- **Auto-Reboot:** Appears when Windows is automatically rebooted.

**Device:** This column shows the individual camera number.

**Mode:** This column shows whether actions are being taken in local side or remote side.

**[Login]** This function shows whom and when has logged in and out the GV-System and WebCam server.

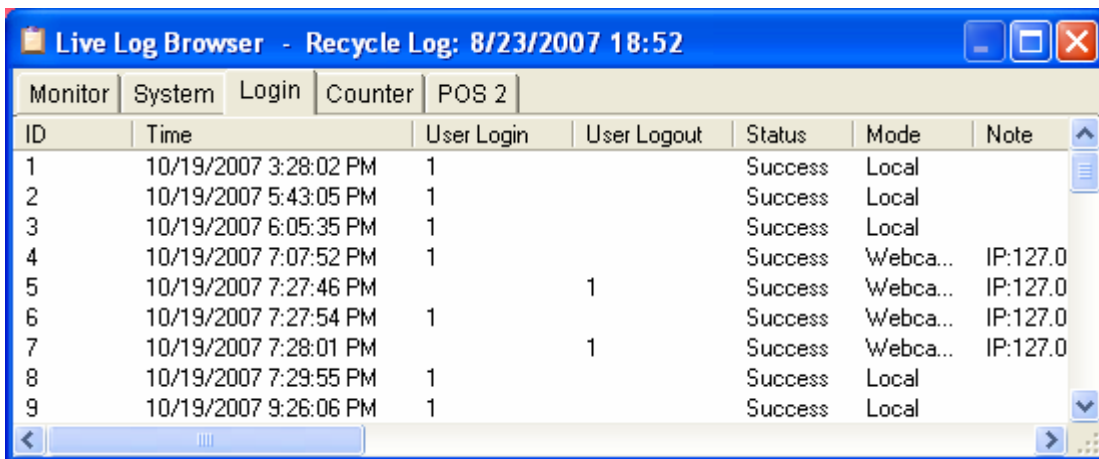

ID	Time	User Login	User Logout	Status	Mode	Note
1	10/19/2007 3:28:02 PM	1		Success	Local	
2	10/19/2007 5:43:05 PM	1		Success	Local	
3	10/19/2007 6:05:35 PM	1		Success	Local	
4	10/19/2007 7:07:52 PM	1		Success	Webca...	IP:127.0
5	10/19/2007 7:27:46 PM		1	Success	Webca...	IP:127.0
6	10/19/2007 7:27:54 PM	1		Success	Webca...	IP:127.0
7	10/19/2007 7:28:01 PM		1	Success	Webca...	IP:127.0
8	10/19/2007 7:29:55 PM	1		Success	Local	
9	10/19/2007 9:25:06 PM	1		Success	Local	

**Figure 1-45**

**ID:** Shows the event ID number

**Time:** This column shows the time when Login event occurs.

**User Login:** This column shows the ID of the login user.

**User Logout:** This column shows the ID of the logout user.

**Status:** This column shows whether login or logout attempts were successful or failed.

**Mode:** This column shows the following messages:

- **Local:** Appears if a user logs in or logs out the Main System.
- **WebCam (Mpeg4):** Appears if a remote client logs in or logs out the WebCam server.
- **TCP:** Appears if a user logs in or logs out the TCP Server.
- **Modem:** Appears if a user logs in or logs out the Modem Server.
- **Multicast:** Appears if a user logs in or logs out the Multicast Server.
- **Remote DVR:** Appears if a Control Center operator logs in or logs out via the Remote DVR service.
- **Remote Matrix:** Appears if a Control Center operator remotely logs in or logs out via the Matrix View service.
- **Remote Desktop:** Appears if a Control Center operator logs in or logs out via the Remote Desktop service.

---

**Note:** This column shows the IP address of the client server.

---

**[Counter]** This function shows the information and result of GV-System's counter function.

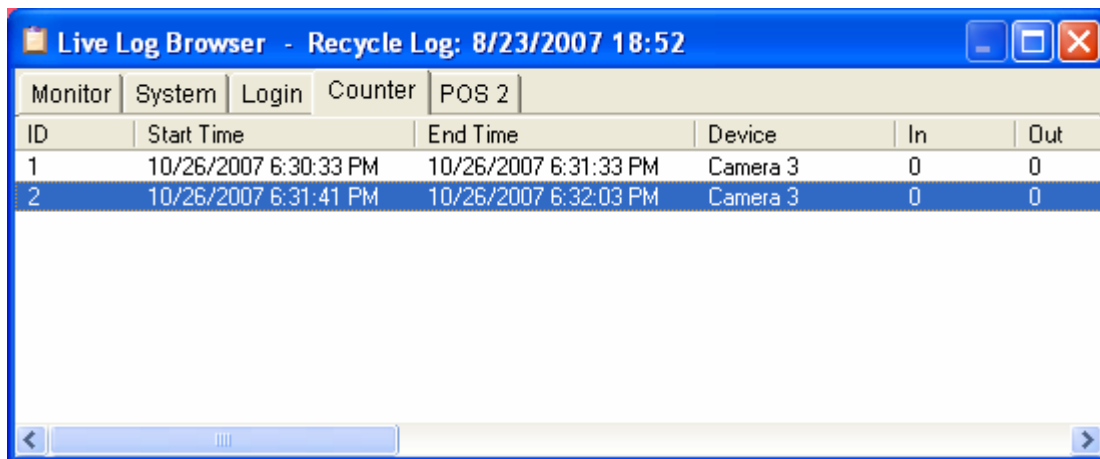

The screenshot shows a window titled "Live Log Browser - Recycle Log: 8/23/2007 18:52". The window contains a table with the following data:

ID	Start Time	End Time	Device	In	Out
1	10/26/2007 6:30:33 PM	10/26/2007 6:31:33 PM	Camera 3	0	0
2	10/26/2007 6:31:41 PM	10/26/2007 6:32:03 PM	Camera 3	0	0

**Figure 1-46**

**ID:** This column shows the event ID number

**Start Time:** This column shows the time when GV-System's counter function is activated.

**End Time:** This column shows the time when GV-System's counter function is terminated.

**Device:** This column shows the camera that performs counter function.

**In:** This column shows the "In" result of GV-System's counter function.

**Out:** This column shows the "Out" result of GV-System's counter function.

**[POS]** This function shows the POS event information. Double-clicking on the log list will allow you to view related video in ViewLog or Quick Search (depending on the video player you selected in the Activate System Log dialog box. See Figure1-26).

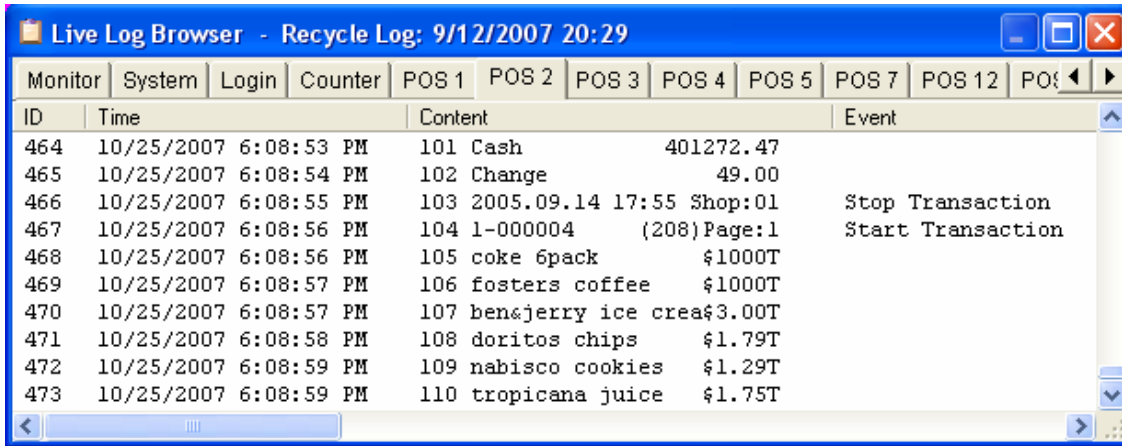

ID	Time	Content	Event
464	10/25/2007 6:08:53 PM	101 Cash 401272.47	
465	10/25/2007 6:08:54 PM	102 Change 49.00	
466	10/25/2007 6:08:55 PM	103 2005.09.14 17:55 Shop:01	Stop Transaction
467	10/25/2007 6:08:56 PM	104 1-000004 (208)Page:1	Start Transaction
468	10/25/2007 6:08:56 PM	105 coke 6pack \$1000T	
469	10/25/2007 6:08:57 PM	106 fosters coffee \$1000T	
470	10/25/2007 6:08:57 PM	107 ben&jerry ice crea\$3.00T	
471	10/25/2007 6:08:58 PM	108 doritos chips \$1.79T	
472	10/25/2007 6:08:59 PM	109 nabisco cookies \$1.29T	
473	10/25/2007 6:08:59 PM	110 tropicana juice \$1.75T	

**Figure 1-47**

**ID:** This column shows the event ID number.

**Time:** This column shows the time when POS event occurs.

**Content:** This column shows the action taken in the POS device.

**Event:** This column shows the following messages.

- **Start Transaction:** Appears when sales transaction starts.
- **Stop Transaction:** Appears when sales transaction ends.
- **Void Transaction:** Appears if an item is being void from the sales transaction.
- **Cash Drawer Open:** Appears if the cash drawer is opened.
- **Filter 1-15:** Appears if the sales transaction matches the defined condition 1 to 15.

---

**Note:** This column is currently not being used.

---



## Recording Schedule

You can program recording, I/O devices, and Center V2 services to turn on and off at specific time each day. Click the **Schedule** button (No.15, Figure 1-2) and select **Schedule Edit** to display the following window.

The window has three major tabs:

- **Video Schedule:** A schedule starts the surveillance system automatically.
- **I/O Schedule:** A schedule starts I/O surveillance automatically.
- **Center V2 Schedule:** A schedule starts the connection to Center V2 services automatically.

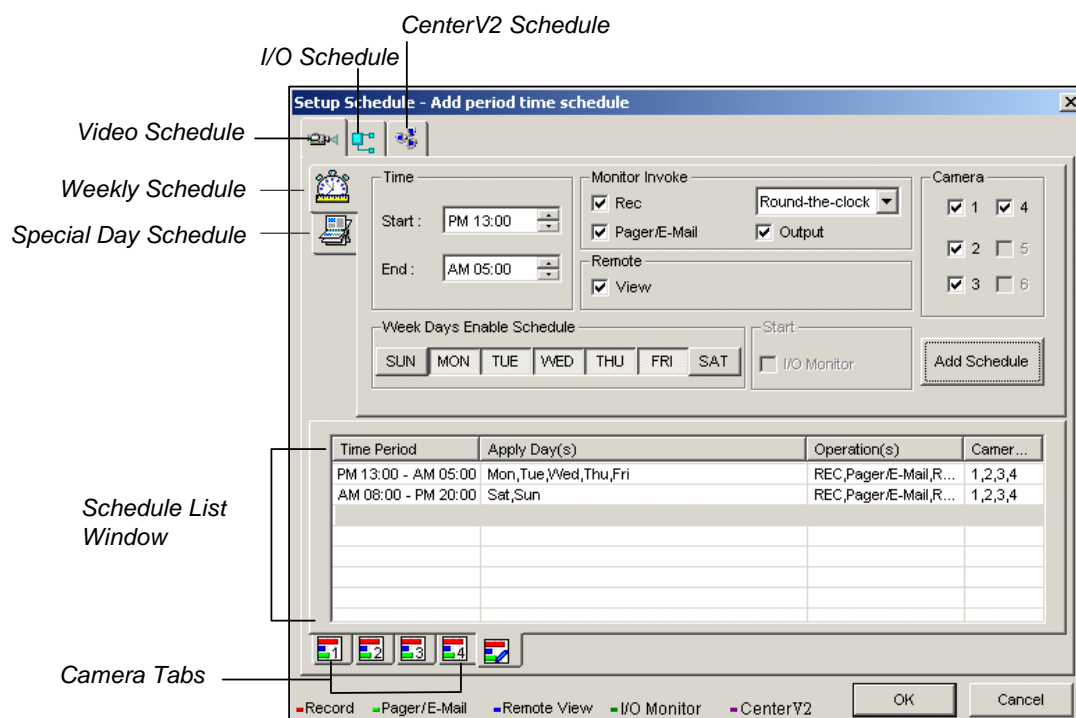

Figure 1-48

## Video Schedule

1. Set your surveillance preferences:

**[Time]** Enter the starting and ending time of the schedule.

**[Monitor Invoke]** Sets alert methods on motion detection.

- **Rec:** Records while monitoring. From the drop-down list, select to record video by Motion Detect or Round-the-Clock.
- **Pager/E-Mail:** Sends pager or e-mail alerts on motion detection.
- **Output:** Triggers the corresponding I/O devices on motion detection. To set up I/O devices, see *Adjusting Individual Camera* earlier in this chapter.

**[Remote]** Sends the triggered images to the remote applications (WebCam, MultiView or RemoteView).

**[Week Days Enable Schedule]** Select days for the schedule.

**[Start]** Only enabled in I/O Schedule.

**[Camera]** Applies the settings to selected cameras.

2. Click the **Add Schedule** tab to apply above settings. The set schedule will display on the Schedule List Window.
3. Repeat above steps to set up more schedules.

Clicking separate Camera tabs, you will see the set schedule is displayed in different color bars:

- **Red:** Recording enabled
- **Green:** Pager/E-mail notification enabled
- **Blue:** System will send videos to Remote View
- **Jade:** I/O monitor enabled
- **Purple:** Center V2 schedule enabled.

To modify a schedule, highlight the desired schedule in the Schedule List window, and then click the **Modify Schedule** button to make changes.

To delete a schedule, highlight the desired schedule in the Schedule List window, and then press the **Delete** key on the keyboard.

## Special Days Schedule

1. Click the **Special Day Schedule** tab.
2. All settings are the same as those in Video Schedule, except the following section. Use the drop-down list and select a date from the pop-up calendar. Click **Apply** to add the date to the schedule.

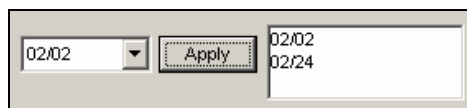

**Figure 1-49**

## I/O Schedule

Set up a schedule to activate the monitoring of I/O devices automatically. All settings are the same as those in Video Schedule, except the following section. After setting up scheduled time and dates, select the **I/O Monitor** option to activate the schedule.

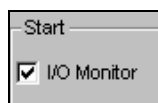

**Figure 1-50**

## Center V2 Schedule

Set up a schedule to connect to Center V2 services automatically. All settings are the same as those in Video Schedule, except the following section. After setting up scheduled time and dates, select the **Center V2** option to activate the schedule. For details on Center V2, see Chapter 1 in *GV-CMS Series User's Manual*.

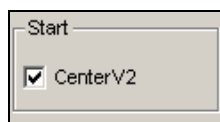

**Figure 1-51**

---

**Note:** If you select the **Center V2** check box without setting up the Center V2 schedule and later enable the Center V2 server, the connection to Center V2 will be stopped automatically after 15 minutes. For this problem, please complete the setup of Center V2 schedule or clear the **Center V2** check box.

---

## PTZ Control Panel

PTZ control panel is used to control PTZ camera operations, camera presets, and magnification functions. This control panel will not appear, unless at least one PTZ camera is connected to the system. Follow these steps to add PTZ cameras to the system:

1. Click **Configure** button (No. 14, Figure 1-2), point to **General Setting**, and select **System Configure**.
2. In the PTZ Control section, select **PTZ Device Setup** to enable the camera drop-down list.
3. Select the model from the list, and press the **PTZ Control** button  to display the camera setup dialog box (which slightly varies on different camera models).
4. In the dialog box, select **Activate**. This is important! Without this step the PTZ camera will not be added to system.
5. Click **OK** and then go back to main screen. Now you should see **PTZ Control** button on main screen. Click the button to bring out the on-screen control panel, shown as follows:

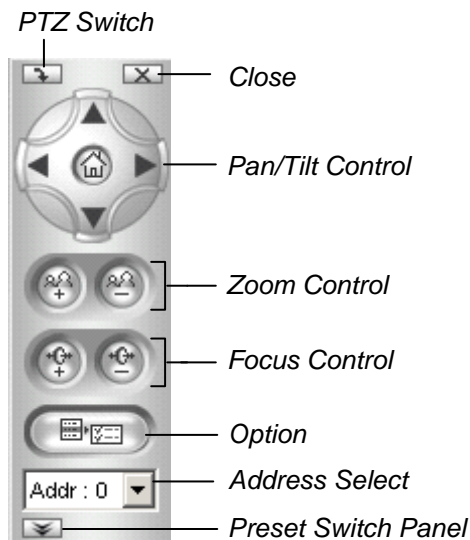

**Figure 1-52**

- **PTZ Switch:** Changes the PTZ device to be controlled.
- **Close:** Closes the control panel.
- **Pan/Tilt Control:** Allows camera to pan back and forth continually among preset points.
- **Zoom Control:** Allows camera to zoom in or out.
- **Focus Control:** Adjusts the camera focus.
- **Option:** Functions included in the Option may be different in terms of various PTZ devices. Consult the manual of the connected PTZ device.
- **Address Select:** Specify the address of the PTZ.
- **Preset Switch Panel:** Moves the PTZ to the preset positions by clicking on the preset number.

---

**Note:** Each dome will need to be addressed correctly. Refer to the dome manufacturers' documentation for details.

---

## Auto Switching PTZ Control Panels

The function allows the corresponding PTZ control panels to be called up automatically when you switch to different PTZ camera screens. To enable the function, follow the steps below:

1. Click the **Configure** button (No. 14, Figure 1-2), point to **General Setting**, and then select **System Configure** to display the System Configure window.
2. In the PTZ Control section, click the **Arrow** button, point to **PTZ Panel Switch** and click **Auto**.

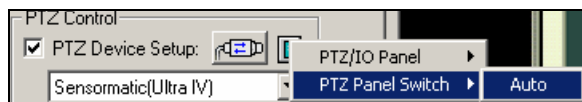
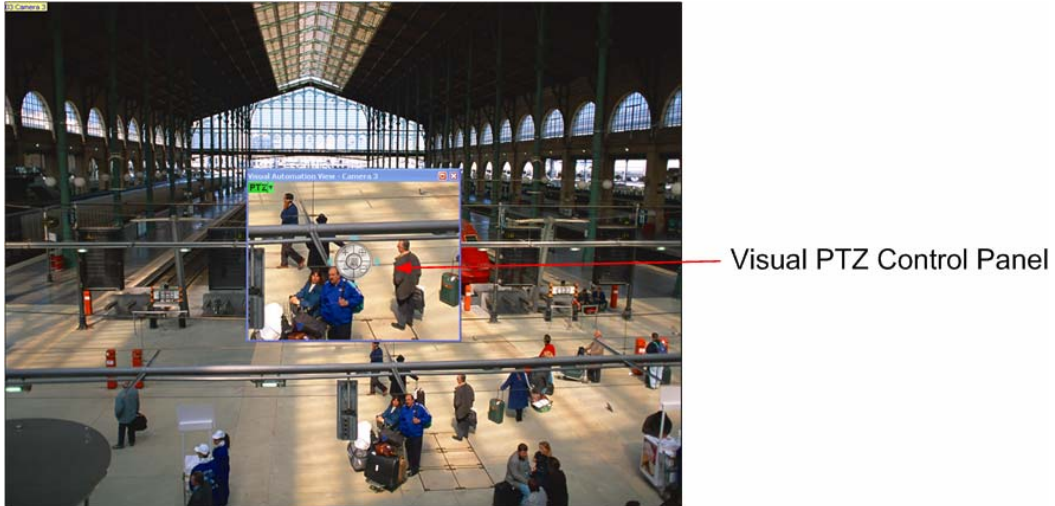

**Figure 1-53**

3. When the Camera Mapping Setup window appears, specify the brand name and hardware address of each PTZ camera. Then click **OK** for the application.

## PTZ Automation

Other than the PTZ control panel, you can display a Visual PTZ Control Panel on the image.



**Figure 1-54**

1. To control the PTZ, you must map one channel to the PTZ camera first. For this, click the **Configure** button (No. 14, Figure 1-2), point to **Accessories**, and select **Camera Mapping PTZ Dome**. For details, see Steps 1-4 in *PTZ Control Panel* earlier in the chapter.
2. To access the new control panel, click on the desired **Camera Name** on the top left corner of every channel, and select **PTZ Automation**. A separate PTZ control window will appear.
3. To change the panel settings, click the green **PTZ** button on the top left corner of the PTZ control window to have these options:

### [PTZ Control Type]

- **Type 1:** In this mode when you place the mouse arrow on the four directions, ex. north, south, east, west, the speed indicator of five levels will appear. Click and hold on the required level of movement and the camera will move as per the specific speed.
- **Type 2:** In this mode with the mouse click, the PTZ control panel will appear. The movement of the camera will depend on the speed of the mouse movement.

### [Configure]

- **Set Color:** Changes the color of the panel. Three kinds of colors are available: Red, Green and Blue.
- **Transparent Degree:** Adjusts the transparency level of the panel. Ten levels range from 10% (fully transparent) to 100% (fully opaque).

## Touch Screen Support

The GV-System offers three types of control panels with touch screen support: PTZ Control Panel, I/O Control Panel and Touch Screen Panel.

### PTZ and I/O Control Panel

This feature gives you the option of a large PTZ and I/O control panel with touch screen support. To open the panel, follow the steps below.

1. Click the **Configure** button (No. 14, Figure 1-2), point to **General Settings**, and select **System Configure** to display the System Configure window.
2. In the PTZ Control section, click the **Arrow** button, point to **PTZ/I/O Panel**, and check **Large**.

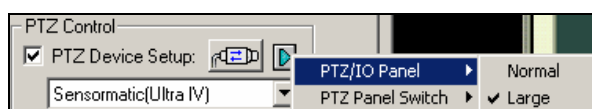
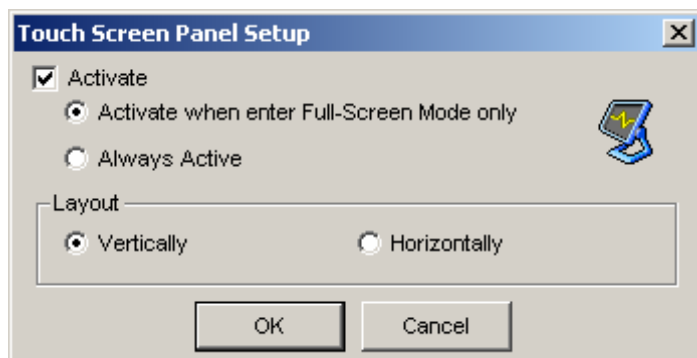

**Figure 1-55**

### Touch Screen Panel

The touch screen panel allows you to switch to ViewLog and full screen by the touch of a finger. To open the panel, follow the steps below:

1. Click the **Configure** button (No. 14, Figure 1-2), point to **Tools**, select **Tool Kit**, point to **Touch Screen Panel** and then select **Panel Setup** to display the following window.



**Figure 1-56**

**[Activate]**

- **Activate when enter Full-Screen Mode only:** Launches automatically the panel when the full screen view is applied.
- **Always Active:** Always displays the panel on the screen.

**[Layout]** Choose a vertical or horizontal panel.

2. Click **OK** to save the above settings.
3. An information window indicating date, time, and storage space will appear at the upper left corner of the screen. Right-click it to open the touch panel as shown below.

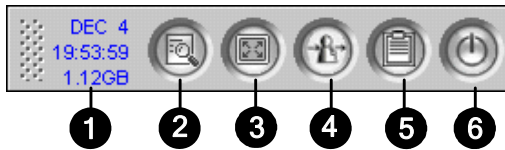

**Figure 1-57**

No.	Name	Description
1	Indicator	Indicates date, time and storage space.
2	ViewLog	Opens the ViewLog.
3	Full Screen	Switches to a full screen.
4	Login / Change User	Switches users to log in the GV-System.
5	System Log	Opens the System Log.
6	Close MultiCam	Closes the GV-System.

**Note:** You can move the touch screen panel anywhere on the screen by dragging it.



## Retrieving Images Using Object Index

The feature allows you to view the very first frame of a *continuous* movement in a video stream. With Live Object Index, you may view the most recent 50 frames captured. With Object Index Search, you may easily locate a desired event and instantly play it back by double-clicking on the image frame.

### Object Index Setup

You can select up to 4 cameras to view live video frames.

1. Click the **Configure** button (No. 14, Figure 1-2), point to **Video Analysis**, and then select **Object Index/Monitor Setup**. The Camera Applied Object Index/Monitor dialog box appears.
2. Check the desired cameras for the application.
3. Click the **Configure** button to display the Video Object Setup window.

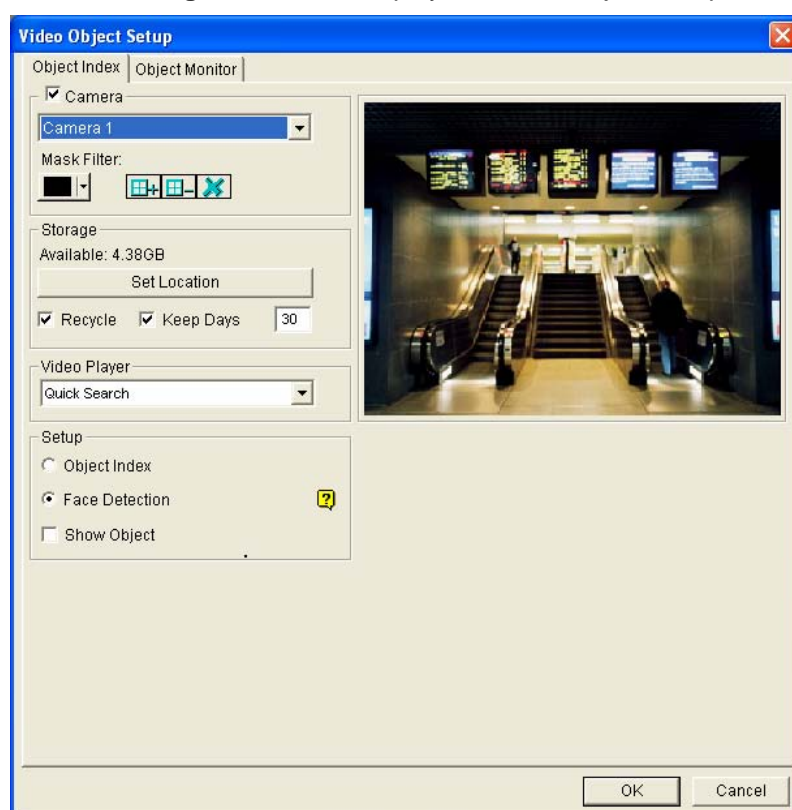

**Figure 1-58** Video Object Setup for Object Index

4. Select one camera from the drop-down list and enable **Camera** for the following setup.
  - **Mask Filter:** Use the mouse to outline a mask area where motion will be ignored.
  - **Set Location:** Click the button to assign a path to save the file.
  - **Keep Days:** Check the item and specify the days to store the files, from 1 day to 999 days.

- **Recycle:** When both Keep Days and Recycle are selected, the system applies whichever condition comes first. For example, if storage space is lower than that is required to hold the days of data specified in Keep Days, recycle comes first.
  - **Video Player:** Select one of these player for playback function: ViewLog or Quick Search.
  - **Show Object:** When motion is detected, it will be outlined with a blue frame.
5. In the Setup section, select **Object Index**.
  6. Click **OK** to apply the settings.

---

**Note:** The minimum storage space required for Object Index is 500 MB.

---

## Live Object Index

After configuring Object Index, you can start to view the most recent frames captured, with 50 frames at most.

1. Start camera monitoring.
2. Click the **ViewLog** button (No. 13, Figure 1-2), and then select **Live Object Index** to display the Live Viewer window.

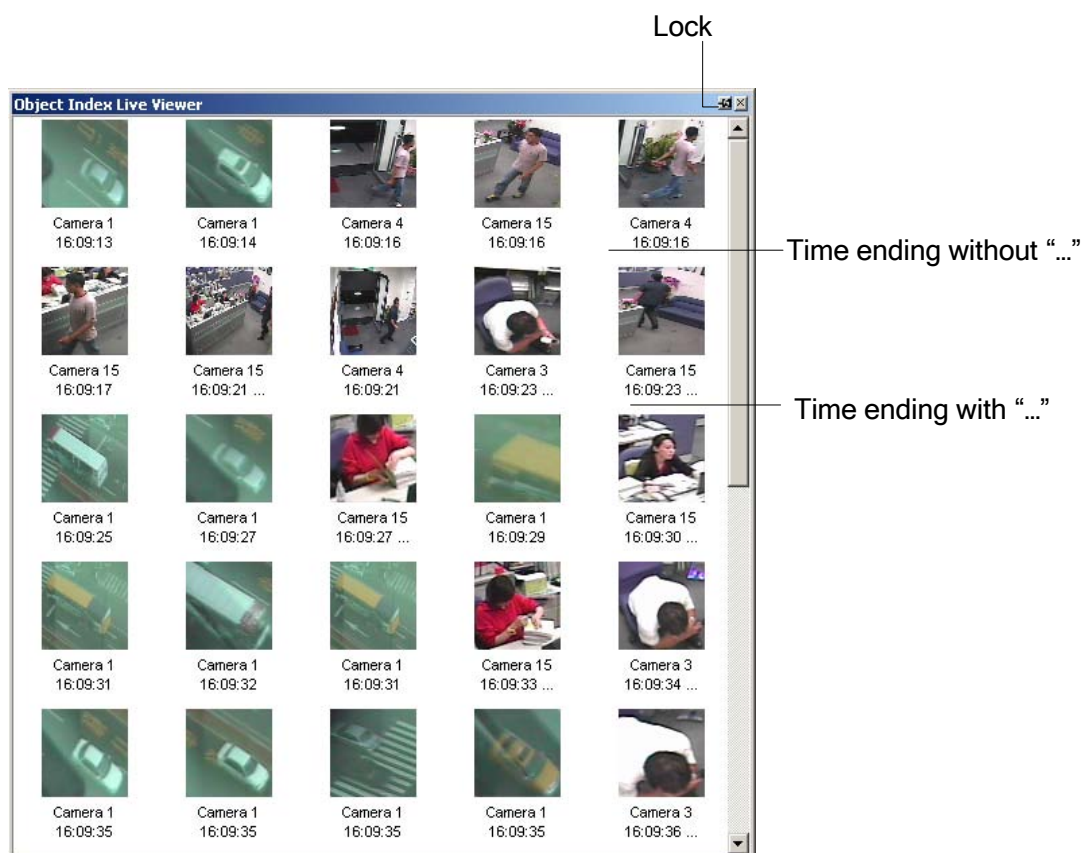

**Figure 1-59**

The controls in the Live Viewer window:

- **The Lock button:** Click to pause the updating process.
- **Time ending without "...":** This means the file is a complete one and can be played back with the ViewLog or Quick Search player. Double-click the file to play it back.
- **Time ending with "...":** This means the video can't be played back since the system is still recording.

## Object Index Search

You can locate frames within selected cameras and a specific time frame.

1. Click the **ViewLog** button (No. 13, Figure 1-2), and then select **Search Object Index** to display the following search window.

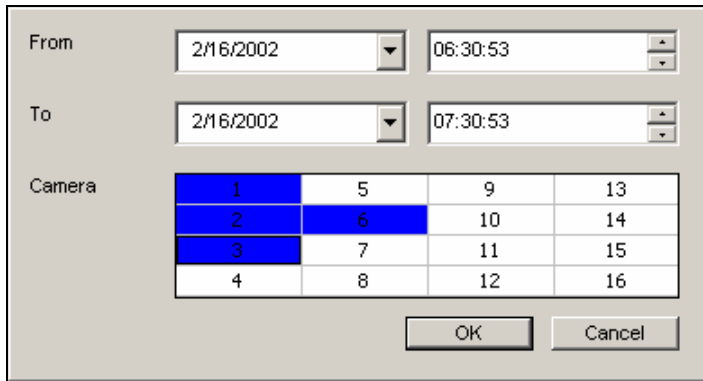

**Figure 1-60** The Search Window

2. Specify a time frame and cameras, and then click **OK** to start searching. The following window will be called up.

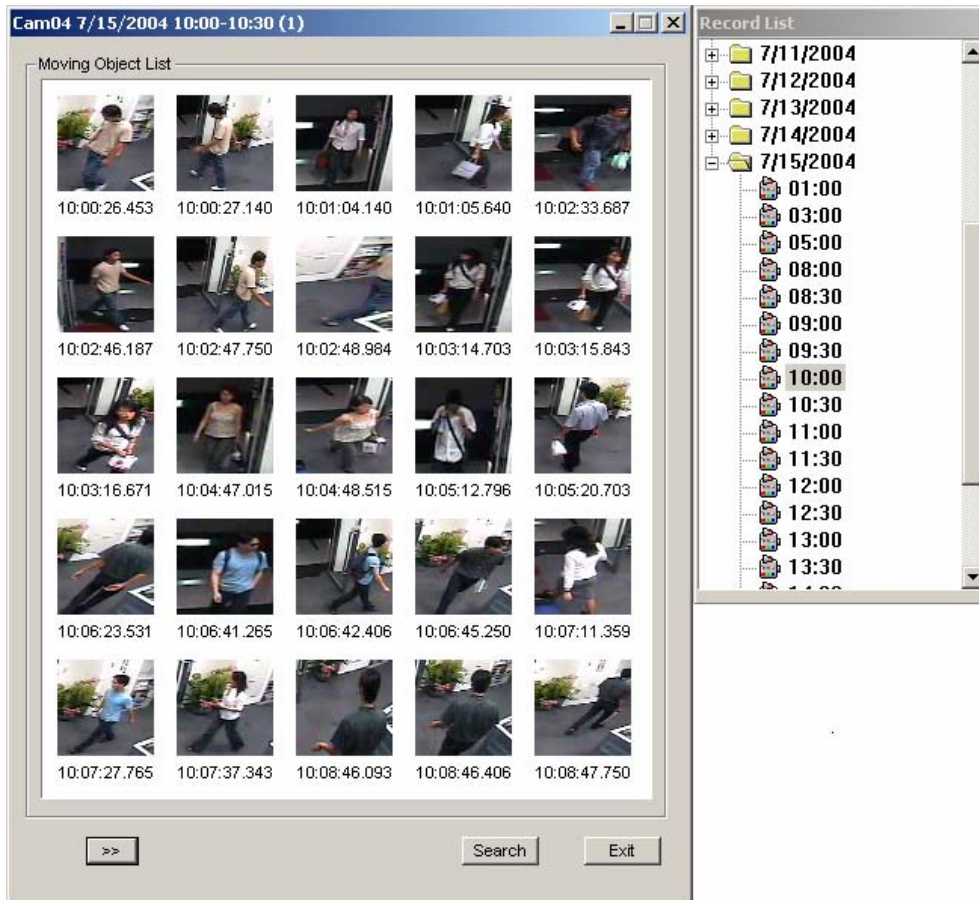

**Figure 1-61** The Moving Object List Window (left) and the Record List (right)

**[The Record List]** The list contains the search results. Double-click a camera folder to display all found files. Click one time-segment file (e.g. 10:00) to open its included frames in the Moving Object List window.

**[The Moving Object List window]**

- **Frames:** Double-click any frame in the window to play back its video file with the Viewlog or Quick Search player.
- : Click the **Next Page** button for the next page.
- **Search:** Click the button to launch the search window.
- **Exit:** Click the button to close the window.

---

**Note:** Every time segment is a 30-minute interval, as shown in Record list in Figure 1-61.

---

## Face Detection

The Face Detection enables the GV-System to identify and record human faces. This feature captures human faces only, ignoring other body parts, objects or background views. Moreover, it can capture each face separately when a group of people comes in the view together.

1. Click the **Configure** button (No. 14, Figure 1-2), point to **Video Analysis**, and select **Object Index/Monitor Setup**. The Camera Applied Object Index/Monitor dialog box appears.
2. Select up to 4 cameras for setup, and then click the **Configure** tab. The Video Object Setup dialog box (Figure 1-58) appears.
3. In the Object Index tab, select the desired camera from the drop-down list and enable **Camera** for setup.
4. In the Setup section, check **Face Detection**, and click **OK** to save the configurations.
5. Start the monitoring of configured camera(s).
6. On the main screen, click the **ViewLog** button (No. 13, Figure 1-2) and select **Live Object Index**.  
When the faces are detected, the thumbnail images will appear on the Object Index Live Viewer.

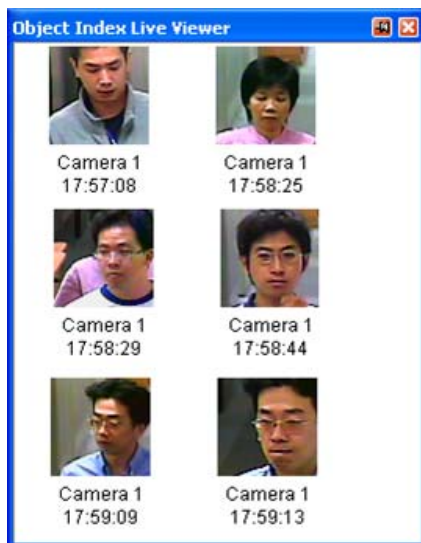

**Figure 1-62**

6. Double-clicking one of images can play back its related video.

For details on the settings in the Video Object Setup dialog box, see *Object Index Setup* earlier in this chapter.

---

**Note:**

- Only faces tilting within the range of 15° vertically and 30° ~ 45° horizontally can be detected.
  - The face to be detected must cover at least 1/10 of the screen.
  - Only full-face images can be detected.
-

## Detecting Unattended and Missing Objects

The Object Monitor program can detect any unattended and/or missing object within the camera view by highlighting its location.

### Detecting Unattended Objects

To detect any unattended objects within the camera view, follow the steps below:

1. Click the **Configure** button (No. 14, Figure 1-2), point to **Video Analysis**, and then select **Object Index/Monitor Setup** to display the Camera Applied Object Index/Monitor window.
2. Check the desired cameras for the application (The checked cameras will also be applied to the settings of Object Index).
3. Click the **Configure** button to display the Video Object Setup window (see Figure 1-63.)
4. Click the **Object Monitor** tab in the upper part to display the following window.

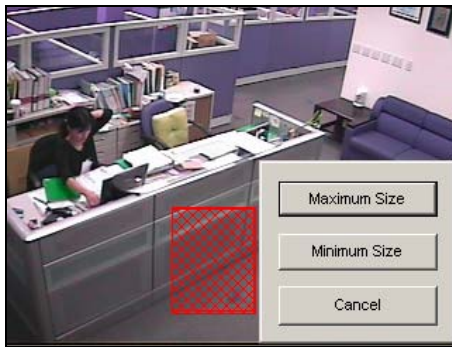

**Figure 1-63** Object Monitor

5. In the Camera field, select a desired camera for setup.
6. Select **Unattended Object** from the drop-down list.



7. Click the **Accept** check box to make other options available.
8. Use the **Mask Filter** function to ignore any motion detection within a certain area if necessary.
9. Click the **Define Object** button.
10. Use the mouse to outline the max and min detection regions separately on the screen. Every time when finishing an outlining, you will be prompted to select **Maximum Size** or **Minimum Size**. See the illustration below.



**Figure 1-64** Defining the min. and max. detection size

11. Click the items of **Show Max** and **Show Min** in the lower of the window one by one to check your defined sizes.
12. Click the **Done** button to finish the defining.
13. Click the **Save Reference Image** button to save the image as a reference view.
14. To set up other options, see *Other controls in the Video Object Setup window* later in this chapter.
15. Click the **OK** button to apply the settings and close the window.
16. Start camera monitoring for the application.

When an unattended object appears and remains stationary for 9 seconds, its location will be highlighted, the selected alarm and output will be activated, and the event will be recorded in System Log for later retrieval.



## Detecting Missing Objects

To detect any object missing from the camera view, follow the steps below:

1. Follow the step 1 to 4 in the above *Detecting Unattended Objects* section to display the Video Object Setup window (Figure 1-63).
2. In the Camera field, select a desired camera for configuration.
3. Select **Missing Object** from the drop-down list.
4. Check the **Accept** option to make other options available.
5. Click the **Define Object** button.
6. Use the mouse to outline regions on the object(s) you want to detect. It is recommended to outline several regions within the object(s) to increase detection sensitivity. Notice that the outlined regions should not be larger than the object(s). Every time when finishing an outlining, you will be prompted to select **Add Region**. See the illustration below.

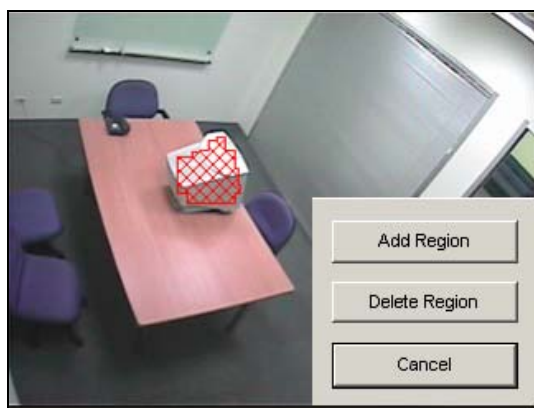

**Figure 1-65** Outlining regions on objects

7. Click the **Done** button to finish the defining.
8. Click the **Save Reference Image** button to save the image as a reference view.
9. To set up other options, see *Other controls in the Video Object Setup window* below.
10. Click the **OK** button to apply the settings and close the window.
11. Start camera monitoring for the application.

When any object, which you have outlined the regions for, disappears from the camera view for 3 seconds, its location will be highlighted, the selected alarm and output will be activated, and the event will be recorded in System Log for later retrieval.

### Other controls in the Video Object Setup window:

- **Show Reference Image:** Click to view the saved reference image.

- **Never Recycle:** When the item is checked, the events of unattended and missing objects won't be recycled by the system.
- **Embed Alarm Region into Recorded Video:** This option will contain the flashing alert boxes in the recorded files so you can easily find out suspicious events during playback. Note that if you are used to searching suspicious events with Object Search, do not enable this option. These flashing boxes can cause false alarms.
- **Live Disable Alarm Region:** When an unattended or a missing object is detected, this option allows you to close the flashing alert box automatically or manually.

Click the [...] button beside to display the Object Index Live Viewer window (Figure 1-66). Select to close the flashing box automatically or manually. Under **Delay Time(s)**, specify the duration of an unattended or a missing object to invoke a warning message (Figure 1-67). The range of delay time is from 1 to 99999 seconds.

Closing the flashing box will disable object detection and alarm settings no matter automatically or manually. To reactive, please restart monitoring.



**Figure 1-66**

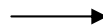

**Figure 1-67**

- **Luminance Change Detection:** This option may suspend object detection when the lighting condition is poor so as to avoid false detection. Use the slide bar to adjust the level of detection from 1 to 5. The higher the level is, the more sensitive the system is to luminance change. When luminance change reaches the level you set, the system will stop object detection.
- **Sensitivity:** Use the slide bar to increase or decrease detection sensitivity if necessary.
- **Delay Time:** This option allows you to specify the duration of an object missing or unattended to invoke the detection.

**Unattended Object:** The duration is from 3 to 1800 seconds, with 3 seconds as default.

For example, suppose you choose 12 seconds. When an unattended object appears in the camera view for 12 seconds, its location will be highlighted.

**Missing Object:** The duration is from 3 to 1800 seconds, with 3 seconds as default. For example,

suppose you choose 9 seconds. When a defined object disappears from the camera view for 9 seconds, its location will be highlighted.

- **Invoke Alarm:** Enables the computer alarm when any unattended and/or missing objects are detected. Click the [...] button next to the item to assign a .wav sound file.
- **Output Module:** Activates the output device when any unattended and/or missing object is detected. Click the [...] button next to the item to assign an installed output module and a pin number.
- **Demo:** Click to see the demonstration from actual DVR applications.

## Object Tracking and Zooming

Object Tracking provides you the real-time tracking and automatic magnification of a single moving object by the combination of one PTZ camera and one stationary camera. If only one PTZ camera is available, it can be applied for Object Zooming, letting you configure four critical views for real-time zooming. The Object Tracking and Object Zooming functions can be combined together by completing both settings.

### Object Tracking

For the tracking function, you need one PTZ camera applied for tracking and one stationary camera set for a fixed view. Currently, GV- System only supports **Sensormatic**, **PelcoSpetra** and **Messoa PTZ**. Install the PTZ camera and the stationary camera in the best possible closing position, so the focus of both could be similar.

#### PTZ Setup

Before configuring the Object Tracking function, first configure the PTZ device.

1. Click the **Configure** button (No. 14, Figure 1-2), point to **General Setting**, and then select **System Configure**. The System Configure window appears.
2. In the PTZ Control section, click **PTZ Device Setup** and select **Sensormatic (Ultra IV)**, **PelcoSpetra 3** or **Messoa (SDS600 series)**. Here we use Sensormatic as example.

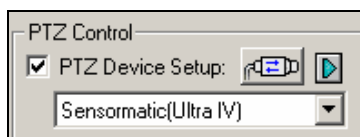

**Figure 1-68**

- Click  to display the Sensormatic Setup window.

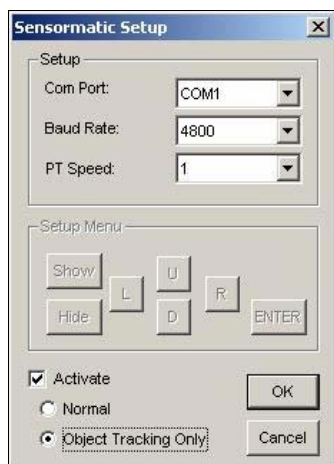

Figure 1-69

- Enter **Com Port**, **Baud Rate** and **PT Speed** of the PTZ camera.
- Check the **Activate** item and select **Object Tracking Only**.
- Click **OK** to apply the settings.

## Object Tracking Setup

After the above PTZ setup, go back to the menu bar. Click the **Configure** button (No. 14, Figure 1-2), point to **Video Analysis**, select **Object Tracking Application**, and click **Object Tracking Setup** to display the following window. The left screen is the PTZ camera view and the right screen is the stationary camera view.

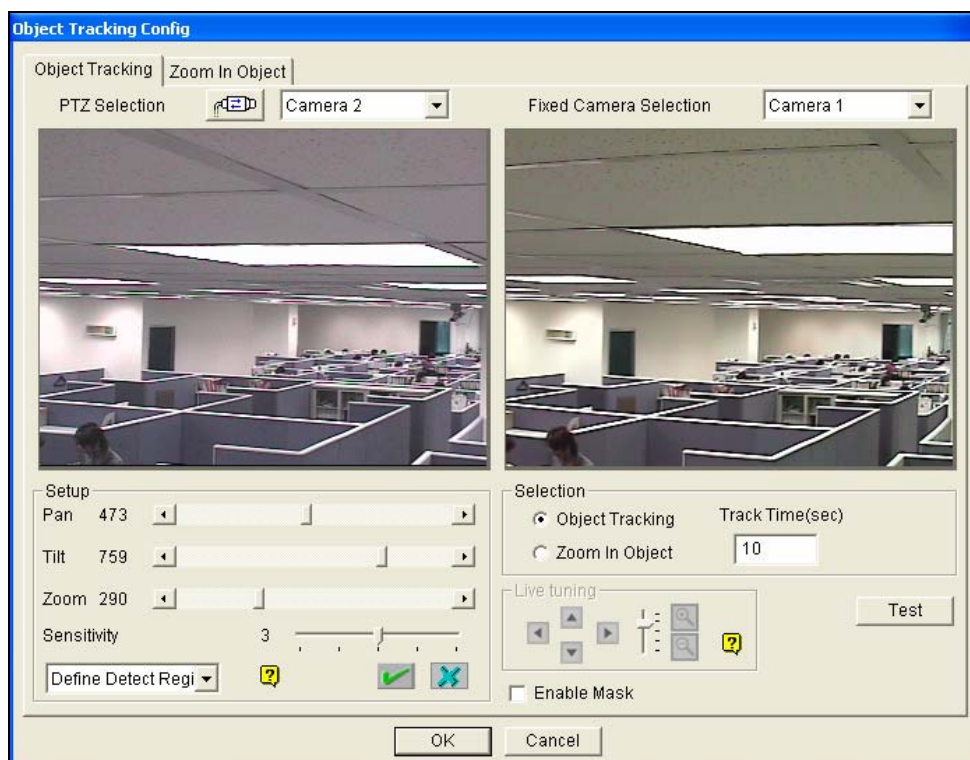



Figure 1-70

**[PTZ Selection]**

- : Click to set up the PTZ.
- **Camera:** Click the drop-down menu to choose the corresponding camera screen of the PTZ.

**[Fixed Camera Selection]** Click the drop-down menu to choose the corresponding camera screen of the stationary camera.

**[Setup]**

- **Pan, Tilt and Zoom:** Use the slide bars to adjust the PTZ camera view.
- **Sensitivity:** Use the slide bar to adjust the detection sensitivity.
- **The drop-down menu:** Click the drop-down menu to define detection region and object size.

**[Selection]**

- **Object Tracking:** Click to specify the tracking time.
- **Zoom in Object:** Click to specify the idle time.

**[Live Tuning]** Adjust directions and the desired level of zooming.

**[Enable Mask]** Click to display the mask on the defined detection region.

1. Click  to display the following window, select the PTZ brand and the hardware address, and click **OK** to apply the settings.

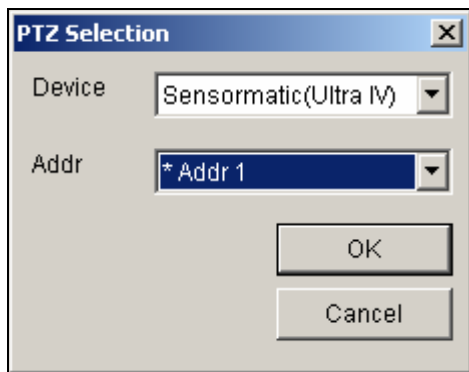

**Figure 1-71**

2. Choose the corresponding camera screens of the PTZ and stationary camera. For this example, the images of the PTZ camera show in the camera 2 screen while the images of the stationary camera display in the camera 1 screen.
3. Adjust the screen view of the PTZ camera with the slide bars of Pan, Tilt and Zoom. Let the PTZ camera view similar to the stationary camera view.
4. Click the **Save** button  to save the both views as image references.
5. Adjust **Sensitivity** or keep it as default.

6. Select **Define Detect Region** from the drop-down menu. Use the mouse to outline a detection region in the right screen; you will be prompted to enter **Detect Region**. See Figure 1-72.

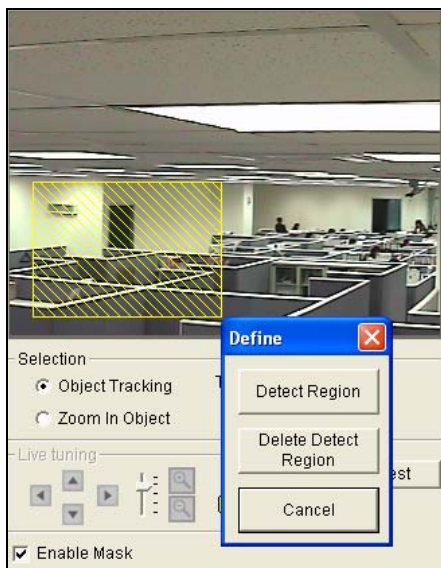

Figure 1-72

7. Select **Define Object Size** from the drop-down menu. Use the mouse to outline the max and min object sizes for tracking separately. Every time when finishing the outlining, you will be prompted to enter **Maximum Object Size** or **Minimum Object Size**. See the illustration below.

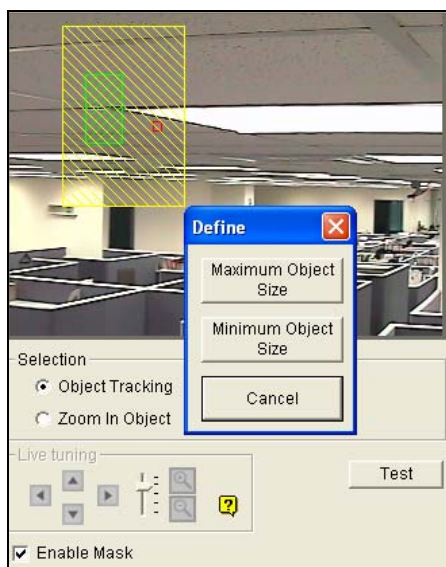

Figure 1-73

8. Click the **Object Tracking** item and specify **Track Time (sec)**. Track Time (sec) indicates the tracking duration in seconds.

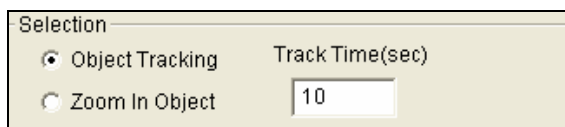
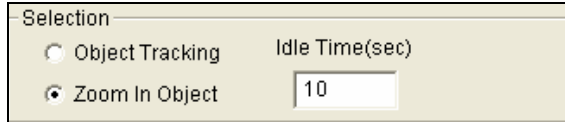

Figure 1-74

- When the PTZ is tracking, you can still control it to zoom in a desired area. Click the **Zoom in Object** item and specify **Idle Time (sec)**. Idle Time (sec) indicates the zooming duration in seconds. If a target appears after the specified idle time, the PTZ will start tracking. If not, the PTZ will remain on the zoomed place.



**Figure 1-75**

- Click the **Test** button to check your settings. There are two major settings you have to observe in the testing. 1) Tracking: Observe if the target showing in the defined detection region is being tracked with a highlighted mask, and magnified automatically in the left screen. If not, increase the sensitivity degree. 2) Zooming: Use the mouse to outline an object in the right screen, and observe if it is magnified in the left screen clearly. If not, use the **Live Tuning** buttons to adjust directions and the desired level of zooming.
- Click **OK** in the lower of the window to save your settings of the tracking time, the idle time for zooming in objects and the testing results.

## Starting Object Tracking

After the above settings, you can start the object tracking application. Click the **Configure** button (No. 14, Figure 1-2), point to **Video Analysis**, select **Object Tracking Application**, and then click **Object Tracking Start** to start the function.



## Zooming in Objects

While the PTZ is being applied for tracking, you can still control it to zoom in any desired area by launching the Zoom in Dialog window.

1. Click the **Configure** button (No. 14, Figure 1-2), point to **Video Analysis**, select **Object Tracking Application**, and then click **Object Tracking View** to launch the Zoom in Dialog window, overlapping in the main screen, as shown below.

---

**Note:** The Zoom In Dialog window is for the stationary camera view and the main screen is for the PTZ view.

---

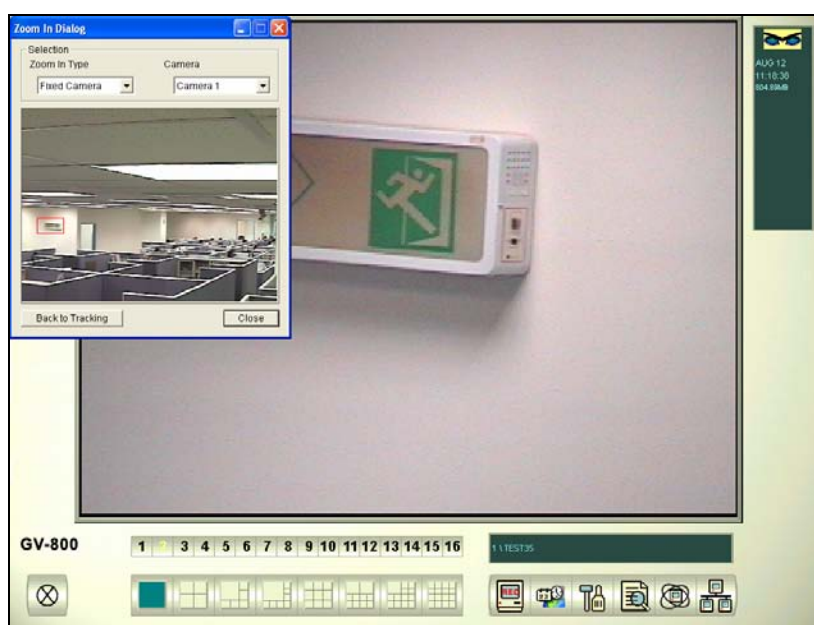

**Figure 1-76** The outlined area in the Dialog window is magnified on the main screen

2. In the Zoom In Type field, select **Fixed Camera**.
3. In the Camera field, select the assigned camera screen for the stationary camera.
4. Use the mouse to outline a desired area in the Dialog window. It will be magnified on the main screen.

When the specified idle time of zooming is up, PTZ will go back for tracking. If you want to stop the zooming function before the specified idle time, click the **Back to Tracking** button in the lower of the Dialog window. Then PTZ will go back tracking instantly.

## Object Zooming

If only one PTZ camera is available, without the stationary camera, you can simply apply it for the object zooming function. The feature allows you to configure up to 4 critical views for instant monitoring and zooming.

### PTZ Setup

Before configuring the Object Tracking function, first configure the PTZ device. Refer to the PTZ Setup of Object Tracking.

### Object Zooming Setup

After the above PTZ setup, go back to the menu bar.

1. Click the **Configure** button (No. 14, Figure 1-2), point to **Video Analysis**, select **Object Tracking Application**, and select **Object Tracking Setup** to display the Object Tracking Config window. Then click the **Zoom in Object** tab in the upper part to display the following window.

---

**Note:** No images will show in the right screen until you complete the settings below.

---

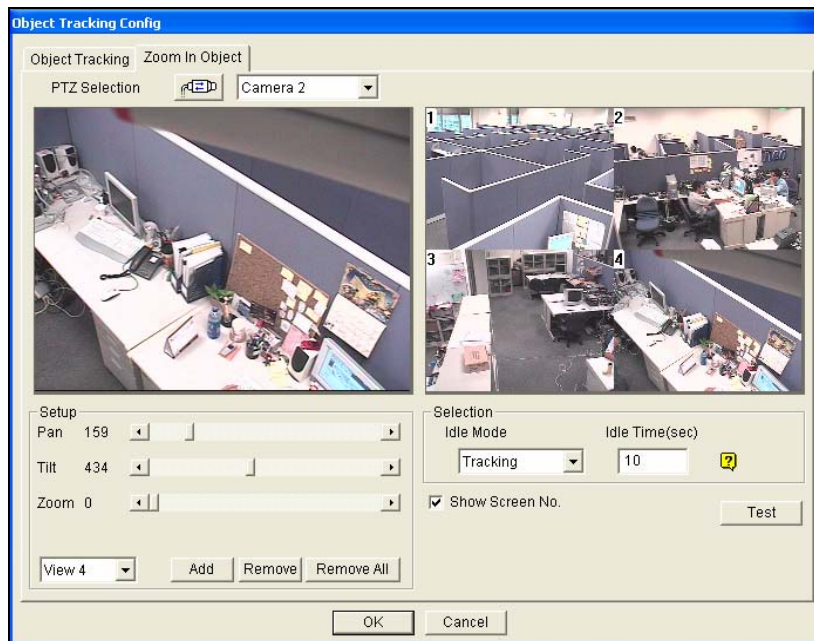

**Figure 1-77**

2. Click  for the PTZ setup. Refer to step 1 in the section of Object Tracking Setup.
3. Choose the camera screen of the PTZ. For this example, the images of the PTZ camera show in the camera 2 screen.
4. Use the slide bars of Pan, Tilt and Zoom to set up the View 1 as shown below. Then click the **Add** button to apply the settings. The View 1 will show in the upper-left corner of the right screen.

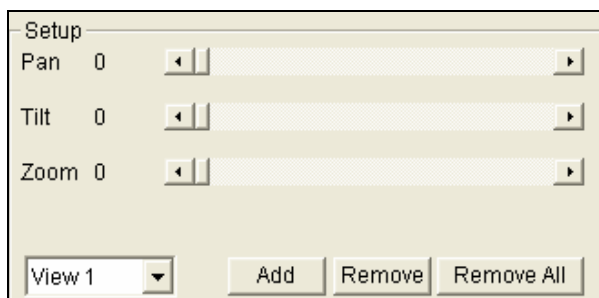

**Figure 1-78**

5. Click the drop-down menu to set up View 2, 3, and 4, one at a time. Refer to Step 4 for the View 1.
6. Specify **Idle Time (sec)**, indicating the zooming duration in seconds.

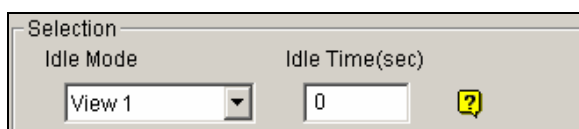

**Figure 1-79**

7. Click the drop-down menu of the Idle Mode item. The seven options included inside are: **None**, **View 1**, **View 2**, **View 3**, **View 4**, **Tracking** and **Refresh View**.
  - **None:** After zooming, the PTZ camera will remain on the same view until the next zooming command.
  - **Tracking:** After the idle time, the PTZ camera will start tracking if it is also being applied for the tracking function.
  - **View 1,2,3,4:** After the idle time, the PTZ camera will go back to the preset View 1, 2, 3, or 4.
  - **Refresh View:** After the idle time, the 4 views will be refreshed.
8. Click **Test** to check your settings. Use the mouse to outline a desired area in one of the four views. The area will be magnified in the left screen.
9. Click **OK** to apply the displayed selections and close the window.

## Starting Object Zooming

After the above settings, you can start the object zooming application.

1. Click the **Configure** button (No. 14, Figure 1-2), point to **Video Analysis**, select **Object Tracking Application**, and click **Object Tracking View** to open the Zoom in Dialog window, overlapping on the main screen (Figure 1-76).
2. In the Zoom In Type field, select **Quad View**.
3. In the Camera field, select the assigned PTZ camera screen. Then the four views you set up before will show in the Dialog window.

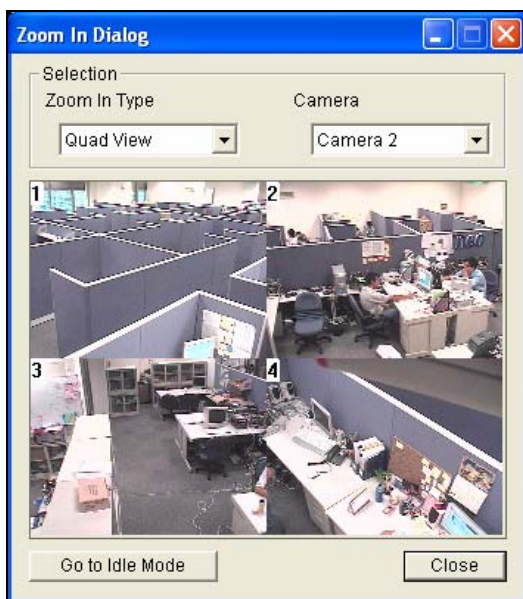

**Figure 1-80**

4. Use the mouse to outline a desired area in one of the four views. The area will be magnified on the main screen.
5. When you click the **Go to Idle Mode** button in the lower part, your setting in step 7 of Object Zooming Setup will be applied. For example, suppose you choose View 3. When you click the button, the PTZ camera will go to the preset View 3.

## Configuring Hybrid Cameras

One Hybrid DVR card supports 4 camera channels and you may install up to 4 Hybrid DVR cards to one GV-System, so that you may configure 16 cameras at most. For details on the Hybrid DVR card, see *Installation Guide*.

If your system is installed with the Hybrid DVR card, follow these steps to configure your cameras:

1. Click the **Configure** button (No. 14, Figure 1-2), point to **General Setting**, select **Camera/Audio Install**, and then select **Hybrid Camera Install**. The Hybrid Video Source dialog box appears.
2. Select the Hybrid DVR channels for setup.
3. Click **Configure**. The Hybrid Camera Configure dialog box appears.

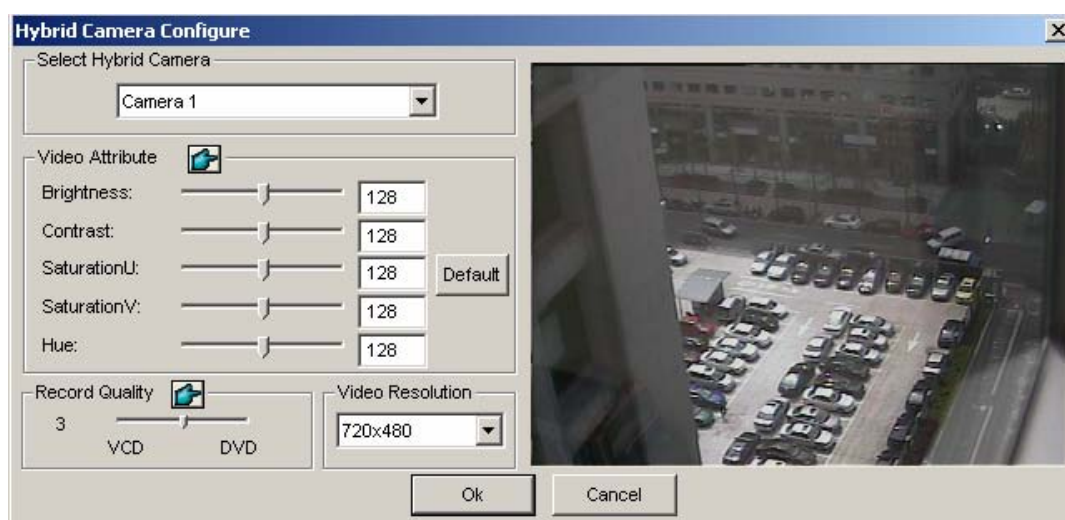

**Figure 1-81**

**[Select Hybrid Camera]** Select a camera for setup. You can see the Hybrid DVR card image of the selected camera in the right window.

**[Video Attribute]** Modify video attributes if necessary. To apply the changes to all cameras, click the **Finger** button.

**[Record Quality]** Select recording quality up to five levels. The recording quality is directly proportional to file size. To apply the change to all cameras, click the **Finger** button.

**[Video Resolution]** Displays the NTSC or PAL resolution for the Hybrid DVR card images.

4. Click **OK** for above settings.

---

**Note:** The Hybrid DVR card only affects recording quality; all live views are still provided by your capture card.

---

## Privacy Mask Protection

The Privacy Mask can block out sensitive areas from view, covering the areas with black boxes in both live view and recorded clips. This feature is ideal for locations with displays, keyboard sequences (e.g. passwords), and for anywhere else you don't want sensitive information visible.

You can also choose to retrieve the block-out areas during playback. The retrievable areas will be protected by password.

### Setting Up a Privacy Mask

1. Click the **Configure** button (No. 14, Figure 1-2), point to **Video Analysis**, and then select **Privacy Mask Setting**. The Privacy Mask Setup dialog box appears.
2. Select the desired cameras for setup, and then click the **Configure** tab. This dialog box appears.

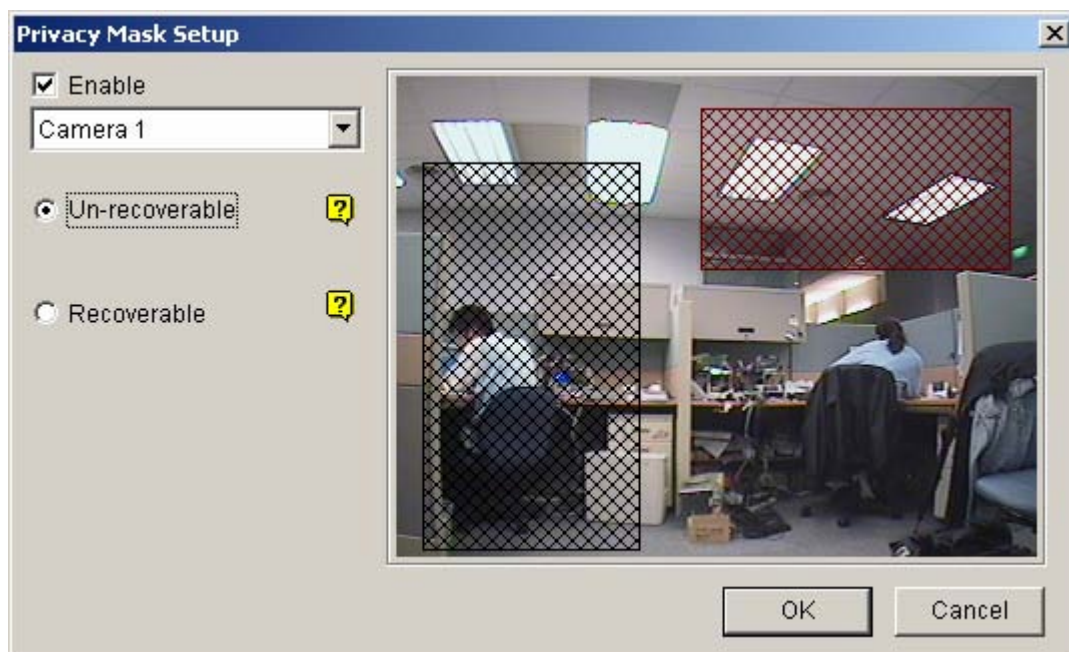

*Figure 1-82 Privacy Mask Setup*

3. Select a camera from the drop-down list, and then check **Enable**.
4. Select Un-recoverable and/or Recoverable.
  - **Un-recoverable:** You cannot retrieve the block-out area(s) in the recorded clips.
  - **Recoverable:** The block-out area(s) is retrievable with password protection.
5. Drag the area(s) where you want to block out on the image. You will be prompted to click **Add** to save the setting. The Un-recoverable region is marked in red, while the recoverable region is shown in green.
6. Click **OK** on the right bottom to save the settings.



## Granting Access Privileges to Recoverable Areas

The user must be granted access privileges to see the block-out areas when launching ViewLog for playback.

1. Click the **Configure** button (No. 14, Figure 1-2), point to **General Setting**, select **Password Setup**, and select **Local Account Edit**. The Password Setup dialog box appears.
2. Select one account, click the **Privacy Mask** tab, and check **Restore Recoverable Video** to grant the privilege.

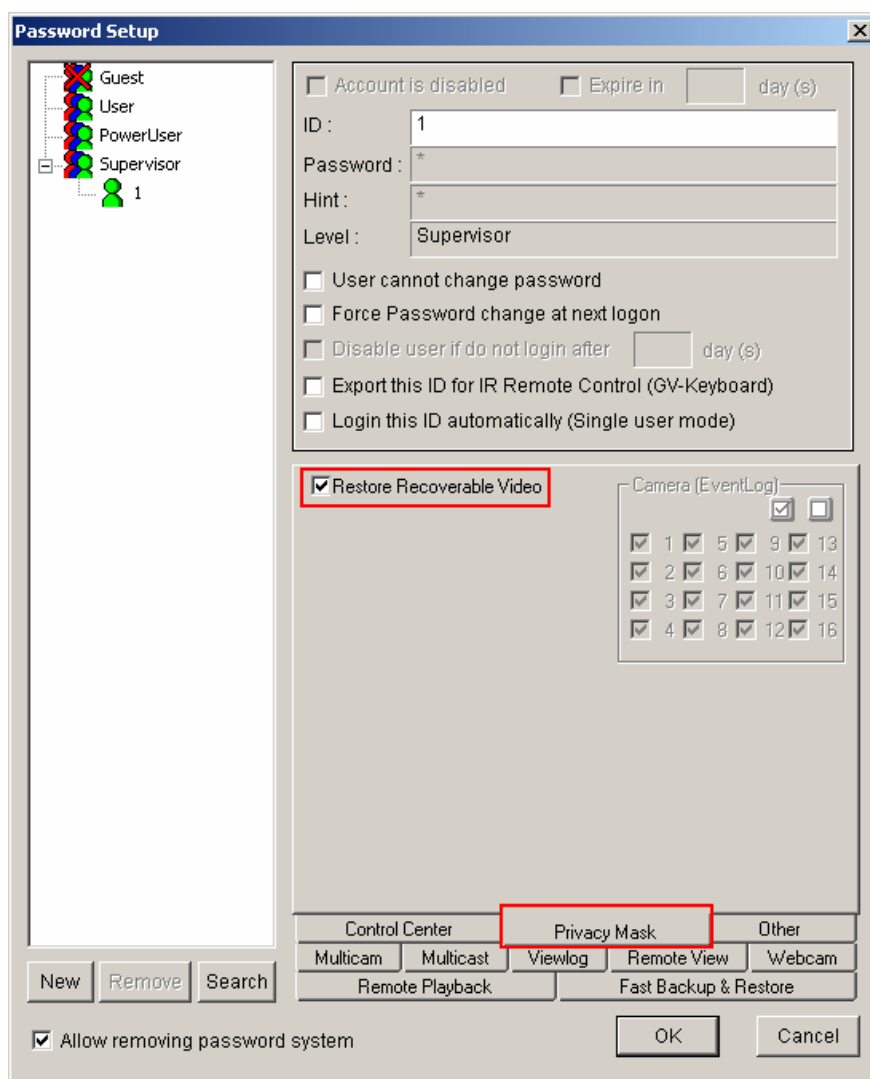

**Figure 1-83**

---

**Note:** If you open the event files (\*.avi) directly from local disks, the valid ID and password are also required to access the block-out areas. For more information on retrieving the block-out areas in the exported files, see *Exporting Privacy Mask* in Chapter 4.

---

## Scene Change Detection

The Scene Change Detection can detect when a camera has been tampered physically. This feature can generate an alert whenever someone or something has covered the lens of the camera, or when the camera has been moved, or when it is out of focus.

1. Click the **Configure** button (No. 14, Figure 1-2), point to **Video Analysis**, and then select **Scene Change Detection Setting**. The Scene Change Detection Setup dialog box appears.
2. Select the desired cameras for setup, and then click the **Configure** tab. This dialog box appears.

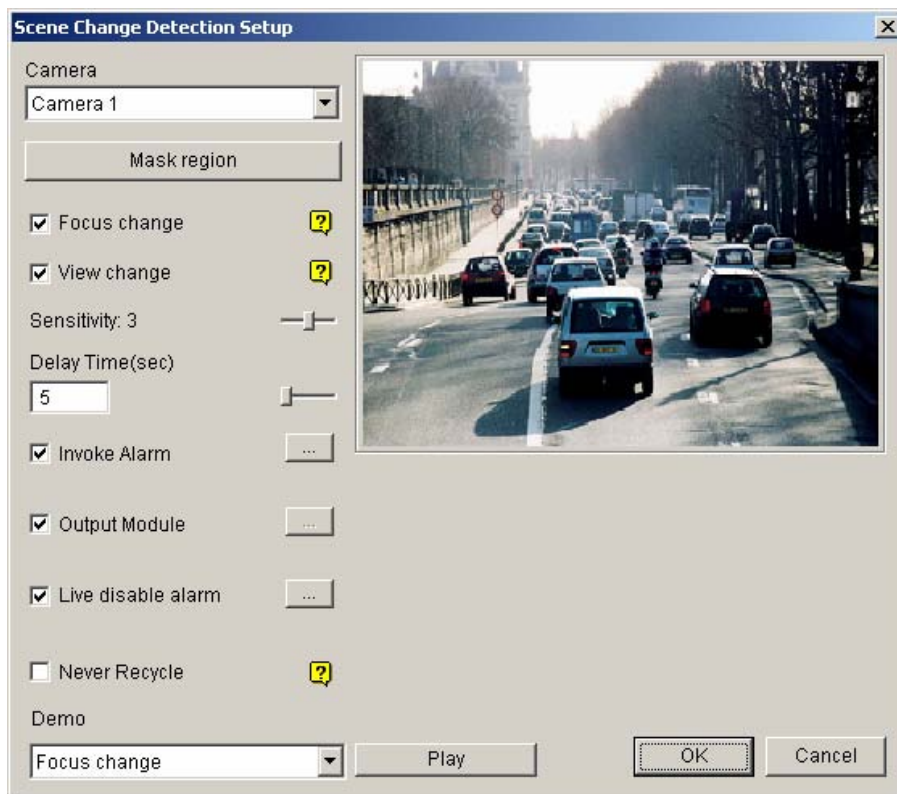

*Figure 1-84 Scene Change Detection Setup*

- **Camera:** Select the camera for setup.
- **Mask region:** Masks off the areas where motion will be ignored.
- **Focus change:** Sends an alert when the camera is out of focus.
- **View change:** Sends an alert when the camera has been moved, or the lens of the camera has been covered.
- **Sensitivity:** Adjusts detection sensitivity. The default value is 3.
- **Delay Time(s):** Sets the duration of Scene Change to record to System Log.
- **Invoke Alarm:** Activates the computer alarm when Scene Change is detected. Click the [...] button beside to assign a .wav sound file.



- **Output Module:** Activates the output device when Scene Change is detected. Click the [...] button beside to assign the output module and pin number.
- **Live disable alarm:** Choose whether to invoke the warning message when Scene Change is detected. Click the [...] button beside to display Figure 1-85.

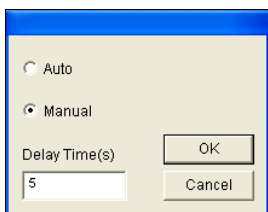

Figure 1-85

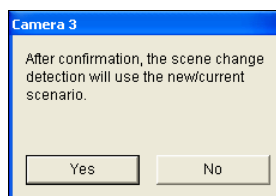

Figure 1-86

If you select **Auto**, there is no warning message. If you select **Manual**, the warning message (Figure 1-86) will appear when Scene Change is detected. Under **Delay Time(s)**, you can define the duration of Scene Change to invoke the message. The range of delay time is from 1 to 99999 seconds.

- **Never Recycle:** When the item is checked, the Scene Change events will not be recycled by the system.
- **Demo:** See three examples of Focus Change and View Change. Click the **Play** button to see the demonstration.

**Note:** When the event of Focus Change or View Change has been detected, it will be recorded as **Scene Change** in System Log for later retrieval.

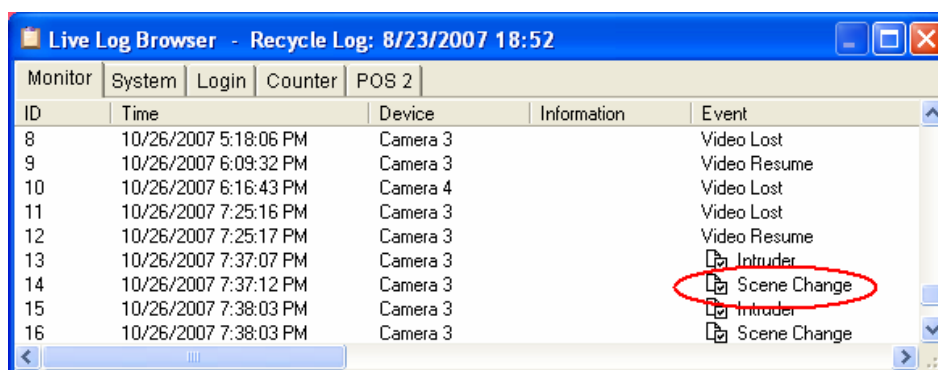

Figure 1-87 System Log

## Advanced Motion Detection

To avoid false motion detection, the Advanced Motion Detection feature provides three solutions:

- Create up to 5 levels of motion detection sensitivity in one region
- Mask off unwanted areas for monitoring, such as cloud and tree movement
- Ignore motion when the lighting condition is poor or changed.

1. Click the **Configure** button (No. 14, Figure 1-2), point to **Video Analysis**, and then select **Advanced Motion Detection Setting**. The Advanced Motion Detection Setup dialog box appears.
2. Select the desired cameras for setup, and then click the **Configure** tab. This dialog box appears.

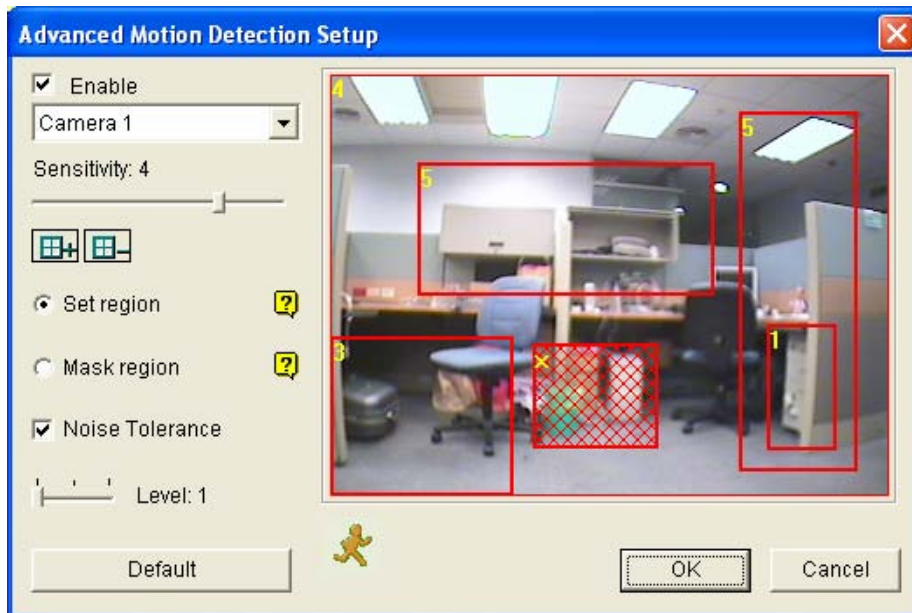

**Figure 1-88** Advanced Motion Detection Setup

3. Select the desired camera from the drop-down list, and then check **Enable**.
4. To set detection sensitivity in a specific area, select a sensitivity level by moving the slide bar, and then drag an area on the image. You will be prompted to click **Add** to save the setting. This setup has sensitivity levels from 1 to 5, with 4 as default.
5. To create several areas with different sensitivity levels, repeat Step 4.
6. If you want to ignore motion in a certain area, click **Mask Region**, and then drag an area on the image.
7. If you want to ignore motion when the lighting condition is poor, check **Luminance Change Detection**.
8. If you want to ignore video noise when light changes, select **Noise Tolerance** and use the slide bar to adjust the level. The higher the level, the more tolerant the system is to video noise.
9. Click **OK** to save your settings.

**Note:**

1. This feature must work with the recording mode of Motion Detection: click the **Configure** button (No. 14, Figure 1-2), point to **General Setting**, select **System Configure**, click the **Camera Record Setting** tab, check **Rec Video**, and then select **Motion Detect** (Figure 1-9).
  2. If you have set up **Motion Sensitivity** and **Mask Filter** in the System Configure settings (Figure 1-9), note that the configurations of Advanced Motion Detection have priority over these settings.
-

## Hard Disk Calculator

Before actual recording, the Hard Disk Calculator allows you to know the required hard disk space and frame size for different types of codecs and quality.

1. Click the **Configure** button (No. 14, Figure 1-2), point to **A/V Setting**, select **Video Attributes**, and then click **Advanced**. The Advanced Video Attributes dialog box appears.
2. Click the **HDD Calculator** button at the right bottom. The HDD Calculator dialog box appears.

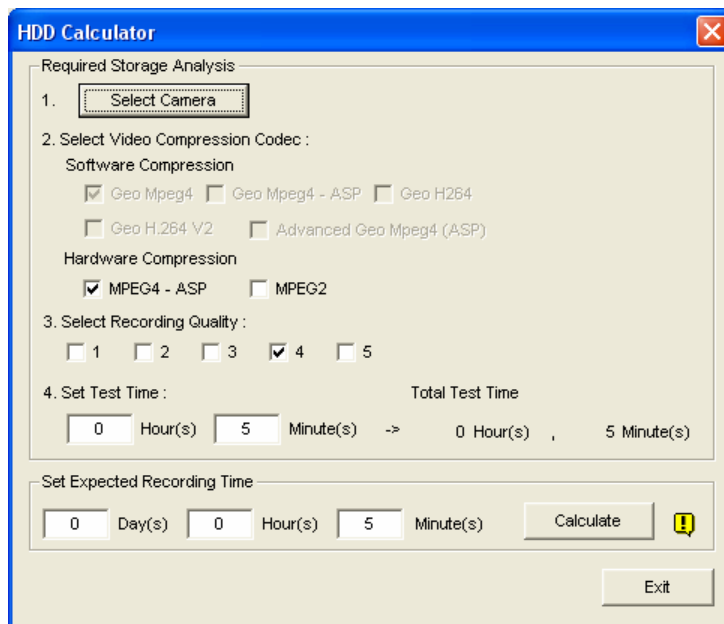

**Figure 1-89**

- **Select Camera:** Select cameras to be used for recording.
- **Select Video Compression Codec:** Check the desired codec(s) to be used for recording. You can choose more than one codec to compare their performance.
  - ⊙ **Software Compression:** Check the desired codec(s) to be used for recording. You can choose more than one codec for performance comparison. This option appears dimmed when GV-2004 or GV-2008 is installed.
  - ⊙ **Hardware Compression:** Check the desired codec(s) to be used for recording. This option is available when GV-2004 or GV-2008 is installed.
- **Select Recording Quality:** Check the desired quality value(s) for recording. You can choose more than one quality value for comparison.
- **Set Test Time:** The system will process a real-time test recording based on the time you set. For example, if you enter 24 hours here, it will take more than one day to do the test recording. So avoid entering the longer test time to save you time.
- **Set Expected Recording Time:** Enter the time you wish for recording.

3. Click the **Calculate** tab to see the result.

---

**Note:**

- A calculation difference by  $\pm 5\%$  from actual disk usage is expected.
  - This function is not available to the GV-NVR users.
-

## Video Noise Solutions

The system provides these solutions for video/audio noise:

- **Noise Tolerance** for motion detection and advanced motion detection
- **Noise Detection to Reduce File Size** for round-the-clock recording
- **Noise Filter** to filter out video and audio noise

### Noise Tolerance

Designed for motion detection, the noise tolerance feature reduces false alarms and unwanted recordings caused by weather or light changes. The level of noise tolerance can be adjusted.

---

**Note:** The noise tolerance function will not change video quality.

---

### Setting Up for Motion Detection

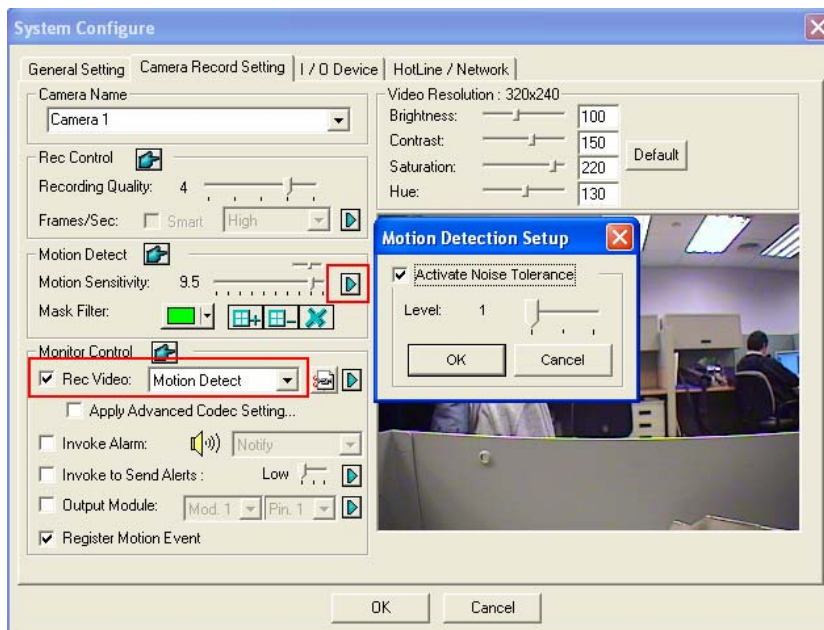

**Figure 1-90**

1. Click the **Configure** button (No. 14, Figure 1-2), point to **General Setting**, and select **System Configure**. In the System Configure dialog box, click the **Camera Record Setting** tab.
2. To set the recording mode to motion detection, enable **Rec Video**, and select **Motion Detect** from the drop-down list.

- To enable noise tolerance, click the right-arrow button next to **Motion Sensitivity** in the Motion Detect section. The Motion Detection Setup dialog box appears.
- Select **Activate Noise Tolerance** and adjust tolerance level. The higher the level, the more tolerant the system is to video noise. If your surveillance area may produce much video noise, set the level to 3. Conversely, set the level to 1 if the surveillance area may produce less video noise.
- Click **OK** to save the settings.

## Setting Up for Advanced Motion Detection

For details, see *Advanced Motion Detection* earlier in this chapter.

## Noise Detection to Reduce File Size

Designed for the round-the-clock recording, the Noise Detection feature can automatically reduce recording size on video noise conditions, and restore normal recording size when the disturbing conditions are over.

- Click the **Configure** button (No. 14, Figure 1-2), point to **General Setting**, and select **System Configure**. In the System Configure dialog box, click the **Camera Record Setting** tab.
- To set the recording mode to Round-the-Clock, enable **Rec Video** and select **Round-the-clock** from the drop-down list.
- Enable **Apply Advanced Codec Setting** and click the  button. This dialog box appears.

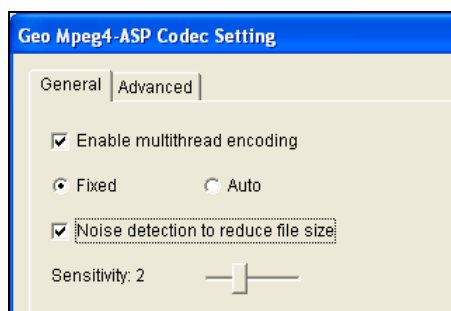

**Figure 1-91**

- Select **Noise detection to reduce file size** and adjust the **Sensitivity** level. The higher the value, the more sensitive the system is to video noise.
- Click **Apply**.

---

**Note:** You can also use this function when the recording mode is set to Motion Detection.

---

## Noise Filter

The Noise Filter function can remove video and audio noise from live view. The video denoising can reduce file size and improve image quality, while the audio denoising can maximize the sound quality.

### Filtering Out Video Noise

1. Click the **Configure** button (No. 14, Figure 1-2), point to **Video Analysis** and select **Video Denoisy Filter Setting**. This dialog box appears.

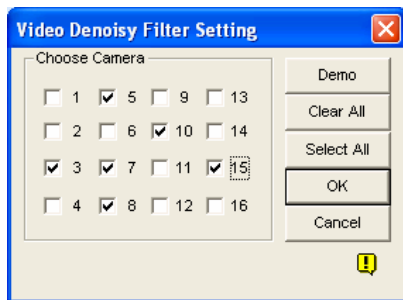

**Figure 1-92**

2. Select the desired channels to be filtered out video noises, and click **OK**. The video noises from the selected channels are reduced, and file sizes are decreased too.

### Filtering Out Audio Noise

1. Click the **Configure** button (No. 14, Figure 1-2), point to **A/V Setting**, select **Wave Out**, and select **Wave Out Denoise**. A dialog box appears.
2. Select the desired channels to be filtered out audio noise, and click **OK**. The audio noises of the selected channels are reduced.



## Panorama View

Spliced from multiple camera images, a panorama view provides a continuous scene for live monitoring.

Each camera selected for the panorama view will keep the recording in original format. Up to 4 sets of panorama views can be created.

---

**Note:** This function is only available when an appropriate USB dongle is used.

---

To access this feature, click the **Configure** button (No. 14, Figure 1-2), point to **Advanced Video Analysis**, select **Panorama Setting**, select the desired cameras on be configured, and then click the **Configure** button. This dialog box appears.

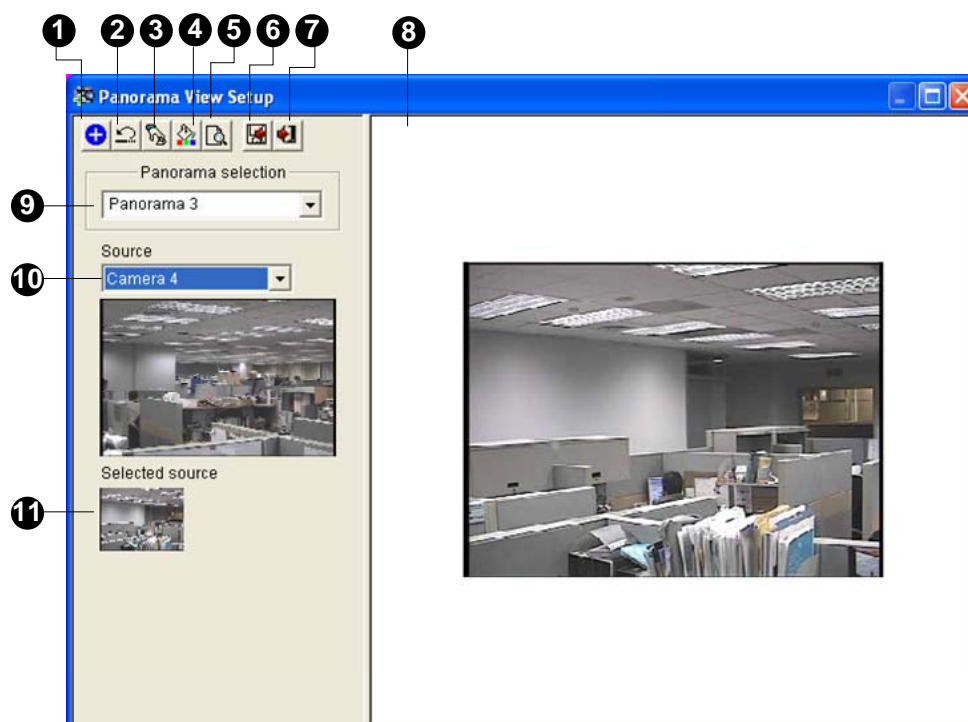

**Figure 1-93**

The controls on the Panorama View Setup dialog box:

No.	Name	Description
1	Add	Adds an image for automatic splicing.
2	Undo	Cancels the settings.
3	Manual Setting	Manually splices the images together.
4	Blending	Makes the spliced images seamless.
5	Demo	Displays the setup procedure.
6	Save Before Exit	Saves the created panorama view and closes the dialog box.
7	Exit	Closes the dialog box.
8	Preview Window	Displays the selected source image or the spliced images.
9	Panorama Selection	Selects the panorama set for the images to be spliced together. Clicks again to rename the panorama set.
10	Source	Selects the source image to be spliced.
11	Selected Source	Displays the selected image.

## Creating a Panorama View

To stitch images from different cameras together, follow these steps:

1. Select one panorama set (No. 9, Figure 1-94) from the drop-down list. If you want to rename the selected panorama set, type the name in the field.
2. Select one camera from the Source drop-down list (No. 10, Figure 1-94) and then click **Manual Setting** (No.3, Figure 1-94). This dialog box appears.

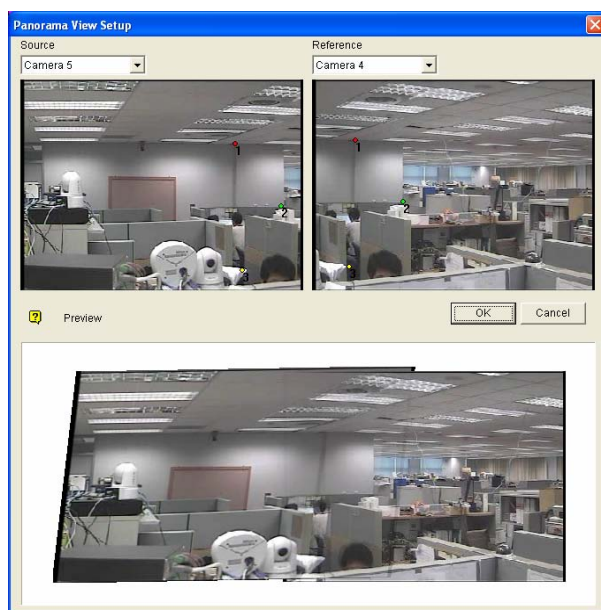

**Figure 1-94**

3. From the Reference drop-down list, select one camera as the Reference image. At this step, the camera you selected at Step 2 will be the only Reference image.
4. From the Source drop-down list, select one camera as the Source image to be stitched with the selected Reference image.
5. To stitch the two images together, click on a significant point in the Reference image and then look for the same point in the Source image. A dialog box of point selection will prompt you to confirm. You need to set up 3 points for stitching.

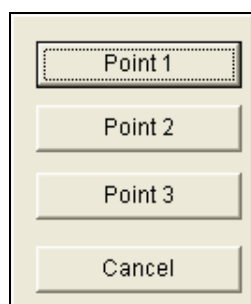

**Figure 1-95**

---

**Note:** For the best result, position the points in the overlapping areas on both images. Avoid placing the points in a cluster or lining them up straight.

---

6. The resulting image is displayed in the Preview window. If satisfied with the result, click **OK** to exit the setup dialog box. If not, re-enter the 3 points for stitching.
7. If you want to stitch a third image or more, click **Manual Setting** and repeat Steps 3 to 5 multiple times.
8. When you finish stitching images, click the **Save Before Exit** button (No.6, Figure 1-93) to save the created panorama view before exiting the Panorama View Setup dialog box.

---

**Note:** The panorama view has a resolution limit of 1920 x 1080. Once the limit is reached, you cannot stitch more images to the created panorama view.

---

## Accessing a Panorama View

Click the **ViewLog** button (No.13, Figure 1-2), point to **Live Panorama View**, and select the desired panorama set from the list. This window appears.



*Figure 1-96*

### Panorama View Controls

Right-click the panorama view to have these options:

- **Snapshot:** Save the current panorama view as an image file.
- **Blending:** Make the two images smoothly blended together. If this is not set, there can be harsh edges in the panorama.
- **Refresh Rate:** When the panorama view is enabled, the system load will increase. Change the refresh rate for the panorama images to optimize system performance. The refresh rate is from **Speed 1 (Slow)** to **Speed 5 (Fast)**.

## Defogging Live Videos

Smoky environments and bad weather, such as rain, snow or fog, all affect image quality and reduce scene visibility. This feature helps to enhance image quality for viewing.

---

### Note:

- This function is only available when an appropriate USB dongle is used.
  - This function takes high CPU and memory usage. Make sure at least 1 GB of DRAM is installed on your system.
- 

1. Click the **Configure** button (No. 14, Figure 1-2), point to **Advanced Video Analysis**, select **Defog Setting**, select up to 4 cameras to be configured, and then click the **Configure** button. This dialog box appears.

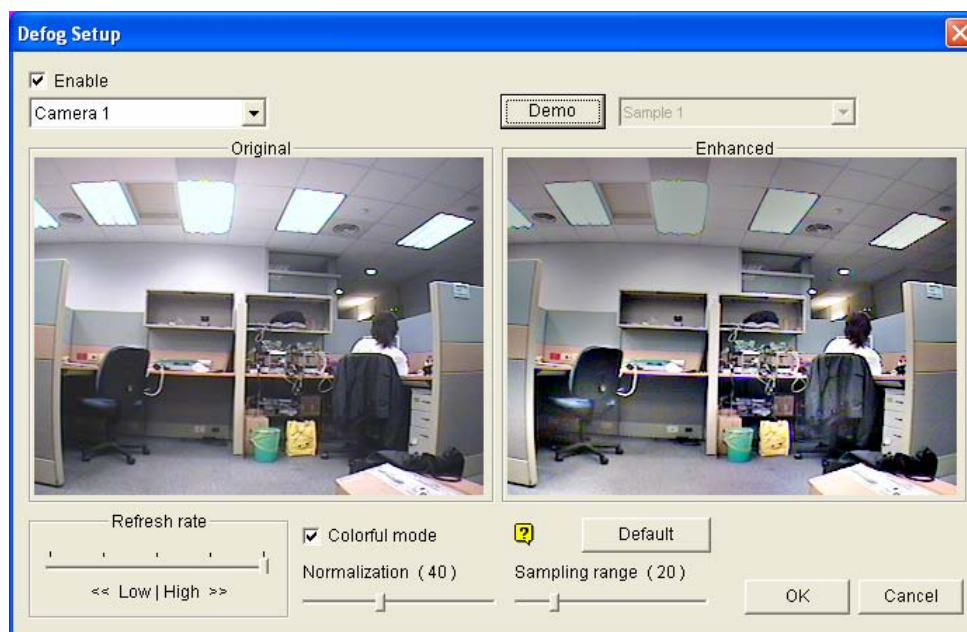

**Figure 1-97**

2. Use the drop-down list to select one camera, and check the **Enable** option.
3. Move the slide bar of **Sampling range (20)** to decrease the fogginess of the image.
4. Check the **Colorful mode** option, and move the slide bar of **Normalization (40)** to adjust the image color.
5. When the image enhancement is enabled, the system load will increase. Adjust the **Refresh rate** by moving the slide bar to optimize system performance.
6. If you want to view the demonstration of this function, click the **Demo** button.

## Video Stabilization

Images from a shaky camera are jittery or blurry. This feature helps to reduce camera shake, leaving you with clear and steady images.

---

**Note:**

- This function is only available when an appropriate USB dongle is used.
  - This function takes high CPU and memory usage. Make sure at least 1 GB of DRAM is installed on your system.
- 

1. Click the **Configure** button (No. 14, Figure 1-2), point to **Advanced Video Analysis**, select **Stabilizer Setting**, select up to 4 cameras to be configured, and then click the **Configure** button. This dialog box appears.

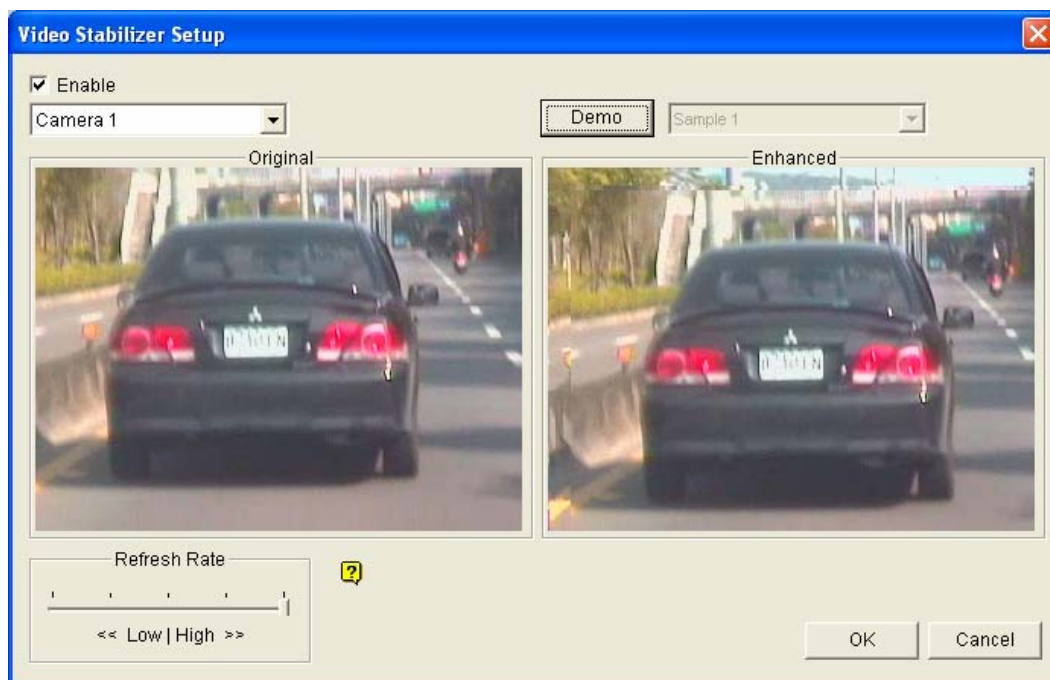

**Figure 1-98**

2. Use the drop-down list to select one camera, and check the **Enable** option.
3. When the image enhancement is enabled, the system load will increase. Adjust the **Refresh rate** by moving the slide bar to optimize system performance.
4. If you want to view the demonstration of this function, click the **Demo** button.



## Picture-in-Picture View

With the Picture in Picture (PIP) view, you can crop the video to get a close-up view or zoom in on the video. This function is useful for megapixel resolution that provides clear and detailed images of the surveillance area.

1. Click the desired camera name and select **PIP View**.
2. The screen automatically switches to one division, and an inset window of the camera view appears in the bottom right corner.

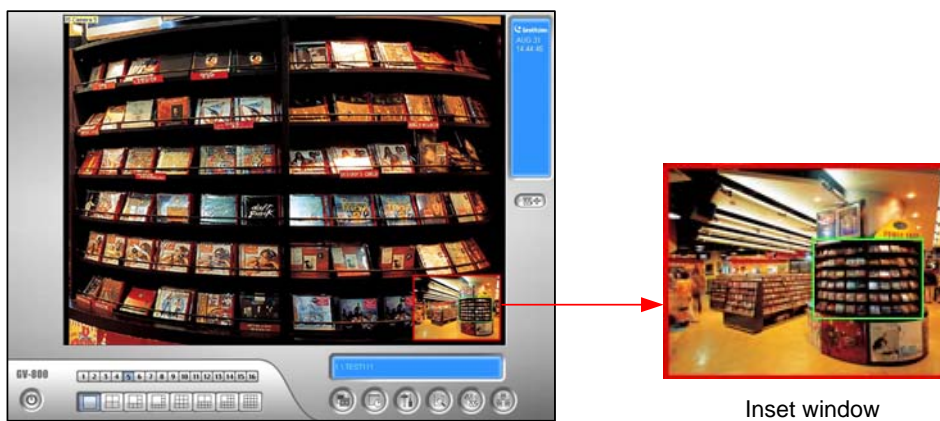

**Figure 1-99**

3. Double-click the inset window. A hand icon appears.
4. Click the inset window. A navigation box appears.



**Figure 1-100**

5. Move the navigation box around in the inset window to have a close-up view of the selected area.
6. To adjust the navigation box size, move the cursor to any of the box corners, enlarge or diminish the box.
7. To change the frame color of the navigation box, right-click the image, select **Mega Pixel Setting**, and select **Set Color of Focus Area**.
8. To exit the PIP view, click the camera name and click **PIP View** again.

## Picture-and-Picture View

With the Picture and Picture (PAP) view, you can create a split video effect with multiple close-up views on the image. A total of 7 close-up views can be defined. This function is useful for megapixel resolution that provides clear, detailed images of the surveillance area.

1. Click the desired camera name on the screen, and select **PAP View**.
2. The screen automatically switches to one division, and a row of three inset windows appears on the bottom of the screen.



**Figure 1-101**

3. Draw a navigation box on the image, and this selected area is immediately reflected in one inset window. Up to seven navigation boxes can be drawn on the image.
4. To adjust a navigation box size, move the cursor to any of the box corners, enlarge or diminish the box.
5. To move a navigation box to another area on the image, drag it to that area.
6. To change the frame color of the navigation box, right-click the image, select **Mega Pixel Setting** and click **Set Color of Focus Area**.
7. To hide the navigation box on the image, right-click the image, select **Mega Pixel Setting** and click **Display Focus Area of PAP Mode**.
8. To delete a navigation box, right-click the desired box, select **Focus Area of PAP Mode** and select **Delete**.
9. To exit the PAP view, click the camera name and select **PAP View** again.
10. To add another navigation box when less than seven navigation boxes are drawn, click the camera name, select **PAP View** to enter, right-click the image, select **Mega Pixel Setting**, and then select **Enable Add-Focus-Area-Mode**.



## DSP Spot Monitor Controller

The Controller integrates the GV-DSP Card with spot monitor (TV monitor) applications. It allows screen divisions on the spot monitor differently from the main screen.

With the Controller, you can also define the channel sequence of the display screen and adjust video images on the spot monitor.

---

**Note:** The GV-DSP-100 Card doesn't support this feature.

---

## Spot Monitor Controller

To open the Spot Monitor Controller, follow these steps:

1. Click the **Configure** button (No. 14, Figure 1-2), point to **Accessories**, select **DSP Spot Monitor**, and then select **Spot Monitor Setup**. This dialog box appears.

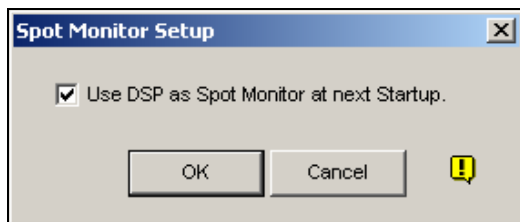

*Figure 1-102*

2. Check **Use DSP as Spot Monitor at next Startup**, and click **OK**.
3. Restart the GV-System.
4. Click the **Configure** button (No. 14, Figure 1-2), point to **Accessories**, select **DSP Spot Monitor**, and then select **Spot Monitor Controller**. The Spot Monitor Control window appears.

---

**Note:** When the DSP Spot Monitor Control feature is enabled, DSP Overlay will be disabled in the Main System.

---

## [Advanced Layout]

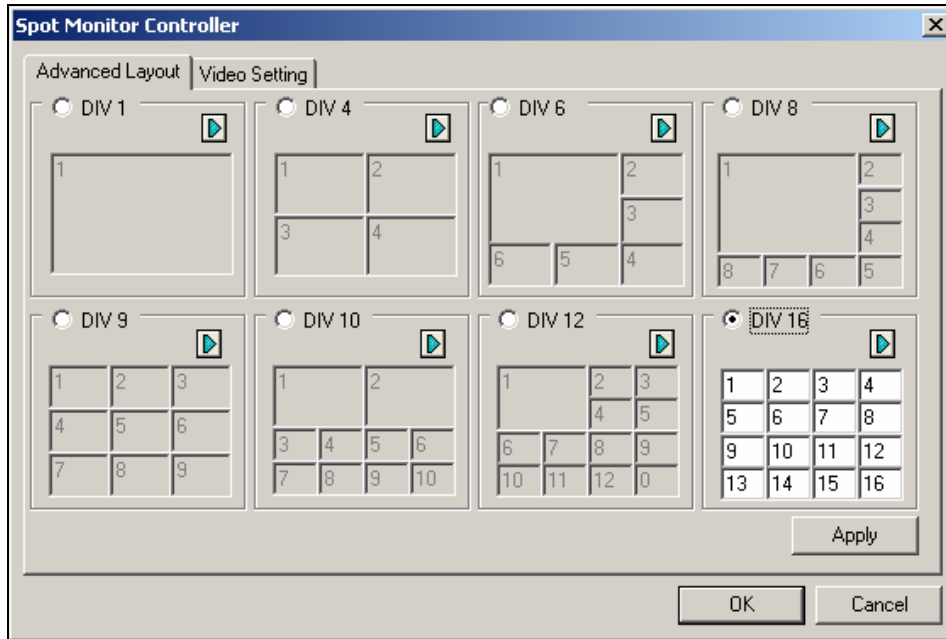

*Figure 1-103 Spot Monitor Controller*

- **DIV 1-16:** Screen division option. You can modify the channel sequence by typing the number directly on each division. Click **Apply** or **OK** to apply your settings.
- **Right Arrow button:** Sets the channel sequence of each scanned page (see the Scan Setting section in Figure 1-105). Click the button to display this dialog box.

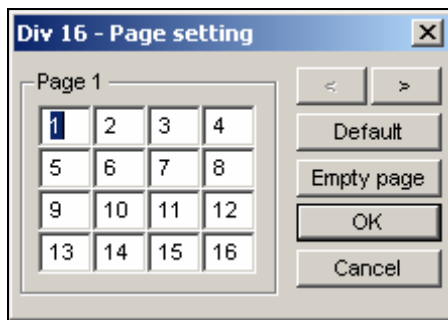

*Figure 1-104 Page Setting*

- ⊙ **Screen Division:** Displays the channel sequence. You can modify the sequence by typing the number directly on each division.
- ⊙ **< > buttons:** Navigate pages.
- ⊙ **Empty page:** Clears up the channel sequence of the open page.

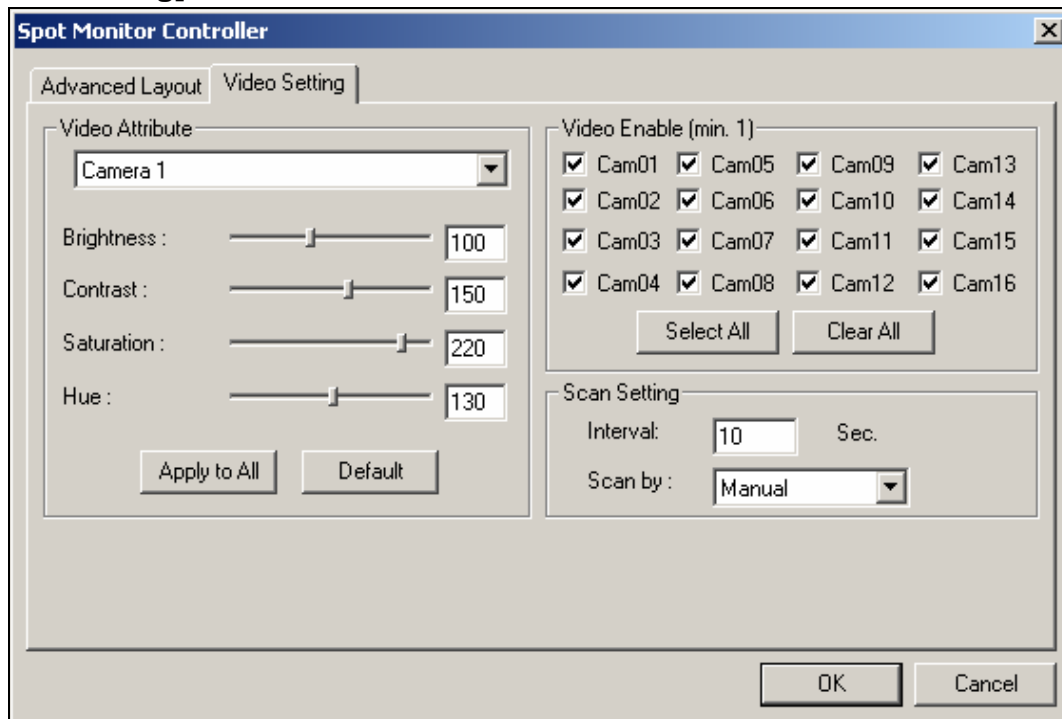
**[Video Setting]***Figure 1-105*

**[Video Attribute]** Select a desired camera from the drop-down list to adjust image attributes, such as Brightness, Contrast, Hue and Saturation.

**[Video Enable]** Check the desired cameras for display on the spot monitor.

**[Scan Setting]** Enter the interval between the scanned pages. Select **Auto** if you want to automatically scan the cameras or **Manual** to scan at your own speed.

## Spot Monitor Panel

On the Main System, click the TV-Out button . This panel appears.

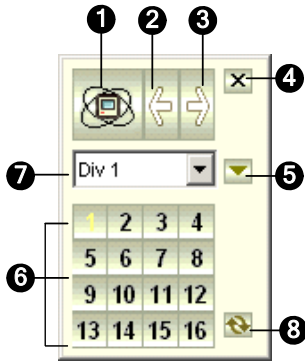

**Figure 1-106**

The controls on the DSP Spot Monitor Panel:

No.	Name	Description
1	Scan	Automatically or manually rotates channels and stops rotation.
2	Previous Page	Goes to the pervious page of the scanned pages.
3	Next Page	Goes to the next page of the scanned pages.
4	Exit	Closes the DSP Spot Monitor Panel.
5	Switch	Opens or closes the channel menu.
6	Channel Menu	Displays the desired channel for single view.
7	Screen Division	Sets screen divisions to 1, 4, 6, 8, 9, 10, 12 and 16.
8	Zoom Esc	After single view, click this button to restore the first scanned page, but to the last channel when the screen division is set to 1.

## Quad Spot Monitors Controller

The Controller integrates the GV-Multi Quad Card with TV monitor (spot monitor) applications. It features:

- Up to 5 TV monitors can be controlled.
- TV Monitor 1 supports up to 16 screen divisions, and TV Monitor 2 to TV Monitor 5 support 1 and 4 divisions.
- Different screen divisions can be set up on each monitor.
- The channel sequence of screen divisions is user-defined.

---

**Note:** The Controller does not support the videos from GV-Video Server.

---

### Setting Up the Controller

Click the **Configure** button (No. 14, Figure 1-2), point to **Accessories**, and select **Quad Spot Monitors Setup**. The TV Quad Setting dialog box appears.

- In the General Setting tab, you can modify Video Format and Video Attribute for all TV monitors.
- In the TV tabs (TV1 to TV5), you can set up the following configurations for each TV monitor.

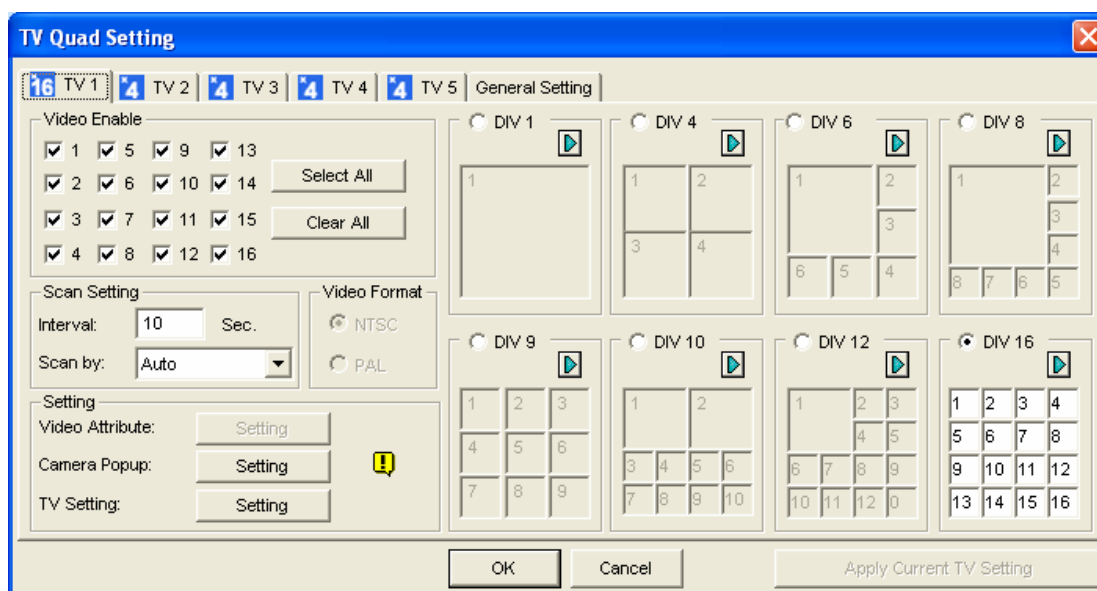

**Figure 1-107**

**[Video Enable]** Check or uncheck the desired channels displayed on monitor screen.

**[Scan Setting]**

- **Interval:** Enter the interval between the scanned pages (see Figure 1-104 for the scanned page). Set the time between 1 and 999 seconds.
- **Scan by:** Select **Auto** to scan the channels automatically or **Manual** to scan at your speed.

**[Setting]**

- **Camera Popup:** See *Setting Pop-up Camera Windows* below.
- **TV Setting:** Click the **Setting** button to display this dialog box.

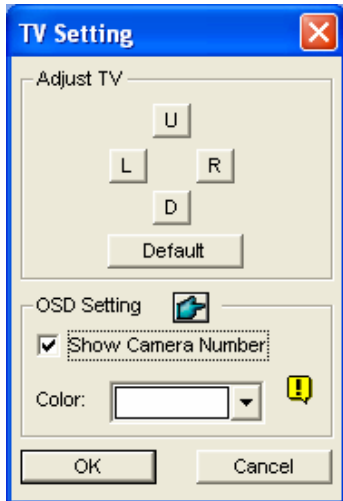

**Figure 1-108**

Press the 4 direction buttons (**U**, **L**, **R** and **D**) to adjust the positions of the divisions on the monitor screen.

To display the camera number on the TV monitor, check the **Show Camera Number** option. To display the camera numbers on all connected TV monitors, check the **Show Camera Number** option, and then click the finger button.

To change the color of the camera number indicator on the TV monitor, use the Color drop-down list to select the desired color.

**[DIV 1-16]** In the TV Quad Setting window (Figure 1-107), there are screen division options. You can modify the channel sequence by typing the number directly on each division. Click **OK** or **Apply Current TV Setting** to apply your configurations.

- **Right Arrow Button:** Sets the channel sequence of each scanned page. Click the arrow button to display this dialog box.

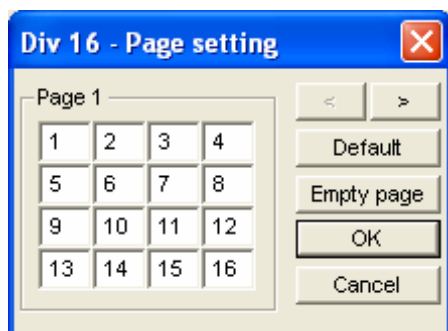

*Figure 1-109*

- ⊙ **Screen Division:** Displays the channel sequence. You can modify the sequence by typing the number directly on each division.
- ⊙ **< > Buttons:** Navigates pages.
- ⊙ **Empty page:** Clears up the channel sequence on the open page.

## Setting Pop-up Camera Windows

The pop-up camera windows on the screen notify users of the current event, whether it is motion or I/O devices being triggered. You can decide to have pop-up cameras on computer screen, TV monitor or both together.

### Activating Pop-up Camera Windows

1. In the TV Quad Setting window, click the desired TV tab.
2. Click the **Setting** button of Camera Popup. This dialog box appears.

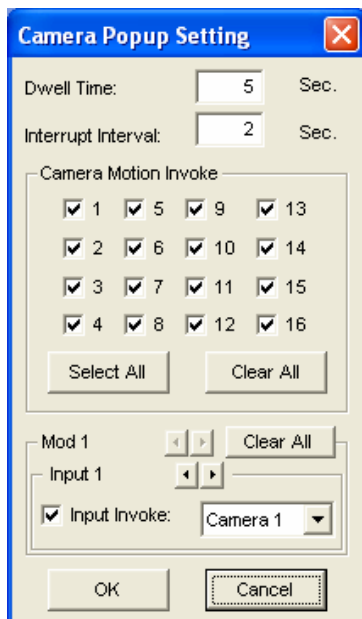

**Figure 1-110**

3. Set the Dwell Time and Interrupt Interval.
  - **Dwell Time:** Specify the amount of time a pop-up view remains on the monitor screen when an event occurs. Set the dwell time between 1 and 120 seconds.
  - **Interrupt Interval:** Specify the interval between pop-up views when events occur. Set the time interval between 1 and 60 seconds.
4. To be alarmed with a pop-up view whenever movement occurs in the video image, select the desired cameras to be popped up in the Camera Motion Invoke section.
5. To be alarmed with a pop-up view when input devices are triggered, select input module and use the drop-down list to select the desired camera to be popped up.
6. Click **OK** to apply the settings.

**Tip:** All cameras can be repetitively setup on different TV monitors. If one camera is selected on more than one TV monitors, it can be set with different alert events.



## Displaying TV Quad Panel on the Main System Screen

On the main screen, click the **TV-Out** button . This panel appears.

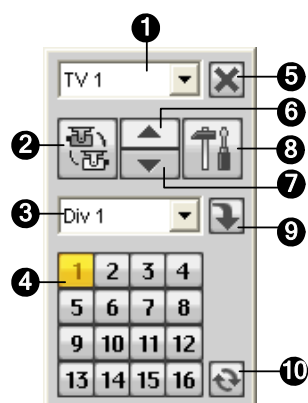

**Figure 1-111**

The controls on the TV Quad Panel:

No.	Name	Description
1	Monitor	Selects the monitor to be controlled.
2	Scan	Automatically or manually rotates channels, and stops rotation.
3	Screen Division	Sets screen divisions. Only TV 1 can support screen divisions up to 16, and TV 2 to TV 5 supports 1 or 4 screen divisions.
4	Channel Menu	Displays the desired channel for single view.
5	Exit	Closes the TV Quad Panel.
6	Previous Page	Scans the previous page.
7	Next Page	Scans the next page.
8	Settings	Displays the TV Quad Setting window.
9	Switch	Displays or hides the channel menu.
10	Zoom Esc	After single view, click this button to return to the first scanned page or return to the last channel when the screen division is set to 1.

**Note:** If the DSP Spot Monitor function is enabled at the same time with the Quad Spot Monitors, the TV-Out button has two options: Spot Monitor Panel and TV Quad Panel. Select the desired panel to be displayed on the screen.

## Running the Quad Spot Monitors Controller Alone

Without starting the Main System, Quad Spot Monitors Controller can be run independently. Find the **QuadTV.exe** in the GV folder and double-click it. The TV Quad Panel (Figure 1-111) will appear.

## System Idle Protection

The System Idle Protection allows the administrator to work on the system without the worry of logout or leaving the system not recording anymore.

This feature can automatically logout the administrator, login a user with no access rights and/or start recording.

### Auto Logout Administrator

If the administrator does not press the mouse or press a key within a set period of time, the system will automatically log him/her out.

1. Click the **Configure** button (No. 14, Figure 1-2), point to **General Setting**, and then select **System Idle Protection Setting**. This dialog box appears.

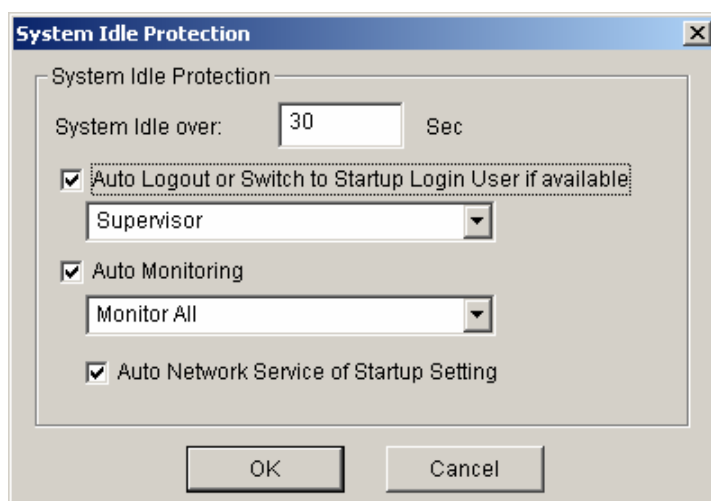

**Figure 1-112**

2. Enable the **Auto Logout or Switch to Startup Login User if available** option, and then select **Supervisor** or **Supervisor, Poweruser** from the drop-down list.
3. In the System Idle Over field, type the idle time from 10 to 300 seconds, after which Supervisor or Poweruser will be logged out.

## Auto Login User without Access Rights

When the system is started up after an idle time, a specified user with no access right will login. This allows the user to see the system is on and working, but at the same time does nothing with the system. The feature must work with the **Startup Auto Login** function.

1. Click the **Configure** button (No. 14, Figure 1-2), point to **General Setting**, and select **System Configure**.
2. In the Startup section, enable **Startup Auto Login**, and click the **Arrow** button beside (Figure 1-3). The Startup Auto Login Setup dialog box appears.
3. Type **ID** and **Password** to set up a user for auto login, and click **OK**.



**Figure 1-113**

4. In the System Idle Protection dialog box (Figure 1-112), select the **Auto Logout or Switch to Startup Login User if available** option, and then select **Supervisor** or **Supervisor, Poweruser** from the drop-down list.
5. In the System Idle Over field, type the idle time from 10 to 300 seconds, after which the specified user will be logged in.

## Auto Start Recording

If the administrator does not press the mouse or press a key within a set period of time, the system will automatically start recording.

1. In the System Idle Protection dialog box (Figure 1-112), select the **Auto Monitoring** option, and select **Monitoring All**, **Schedule Monitoring** or **I/O Monitoring** from the drop-down list.
2. In the System Idle Over field, enter the idle time from 10 to 300 seconds, after which the system will start recording.

---

**Note:** The feature can monitor keystrokes or mouse clicks, even from IR Remote Control and GV-Keyboard.

---

## Creating Shortcuts

You can create up to 20 shortcuts on the main screen to a program or file.

1. Run **Fast Backup & Restore Main System** from the Windows Start menu. The Fast Backup & Restore Multicam System window appears.
2. Click the **Select Skin Style** button, select **DVR**, and then select **User Define Setting**. This dialog box appears.

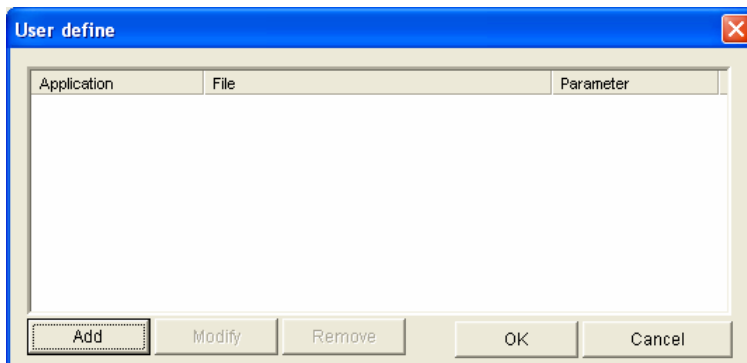

**Figure 1-114**

3. Click the **Add** button. This dialog box appears.

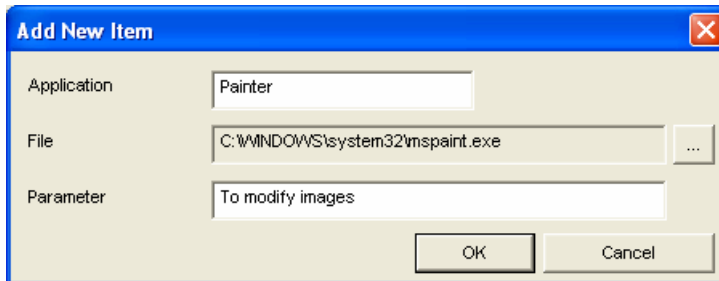

**Figure 1-115**

- **Application:** Names the desired application to be pointed to.
  - **File:** Assigns the path to the desired application.
  - **Parameter:** Sets the command information for the application.
4. Click **OK** to save all the configurations.
  5. Run the Main System. The shortcut button  appears.

## Hybrid and NVR Solution

The GV-System provides a **hybrid solution** that integrates analog videos with digital videos from IP video devices. The IP video devices GeoVision provides include **GV-IP Camera**, **GV-Video Server** and **GV-Compact DVR**. GeoVision also launched a software-based system **GV-NVR** exclusively for IP video surveillance. GeoVision's hybrid and NVR solution support not only own-brand IP video products but also products from leading manufacturers.

For details on supported IP camera models, see *Supported IP Devices* later in this chapter.

---

**Note:** GV video capture cards GV-250, GV-2004 and GV-2008 do not support the Hybrid solution.

---

## GeoVision IP Video Products

GeoVision offers a comprehensive line of IP video products:

- **GV-IP Camera:** A megapixel IP camera.
- **GV-Video Server:** Converts up to 2 analog cameras into IP cameras.
- **GV-Compact DVR:** Converts up to 4 analog cameras into IP cameras.
- **GV-NVR:** A complete software-based solutions for IP video surveillance.

## Dongle Type

There are two types of USB dongles available for the Hybrid and NVR solution.

- **NVR (GV) Dongle:** This is used for GeoVision IP devices.
- **NVR Dongle:** This is used for third-party IP devices, or a mix of GeoVision and third-party IP devices.

## Hybrid Solution Description

1. **Specifications of the Hybrid solution.** The Hybrid solution supports the maximum of 8 IP video sources with the limit of 16 channels in total, e.g. 8 analog videos + 8 IP videos = 16 channels. If more than 8 IP videos are required, you may choose the **GV-NVR** solution with support for up to 16 IP video channels.
2. **Connection of GeoVision IP devices to GV-System.** The Hybrid solution accepts all IP videos from GV-IP Camera, GV-Video Server and GV-Compact DVR. There is no need to use a USB dongle.
3. **Connection of third-party IP devices to GV-System.** To implement the Hybrid solution with third-party IP video devices, you need **NVR Dongle** from GeoVision.
  - The dongle options include: 1, 2, 4, 6, 8 IP channel(s).

## NVR Solution Description

1. **GV-NVR** is a complete software-based surveillance solution without using a video capture card. Video inputs to the GV-NVR must be IP video sources. Up to 16 IP video channels are supported.
2. **Connection of Geovision IP devices to GV-NVR.** To implement the GV-NVR solution with GeoVision IP video devices, you need **NVR (GV) Dongle** from GeoVision.
  - Dongle options include: 4, 8, 12, 16 IP channels.
3. **Connection of third-party IP devices to GV-NVR.** To implement the GV-NVR solution with third-party IP video devices, you need **NVR Dongle** from GeoVision.
  - Dongle options include: 1, 2, 4, 6, 8, 10, 12, 16 IP channel(s).

**NVR Dongle** also accepts a mix use of both GeoVision and third-party IP devices.

---

**Note:** The USB dongles will enable GV-NVR to receive any kind of streaming from the IP video devices including VGA or Megapixel streaming.

---



## Adding IP Video Sources

The setting procedures may vary slightly among IP camera, video server and compact DVR. The following procedures are the example of setting up an IP camera in the system:

1. Click the **Configure** button (No. 14, Figure 1-2), select **General Setting**, select **Camera / Audio Install** and click **IP Camera Install**. This dialog box appears.

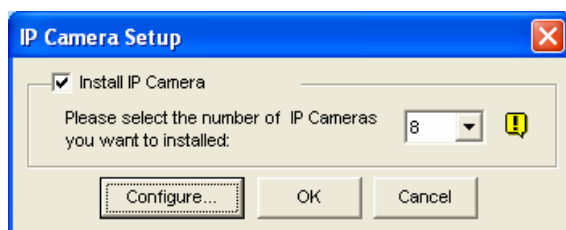

**Figure 1-116**

2. Check **Install IP Camera**, select the number of IP cameras you want to link to, and click **Configure**. This dialog box appears.

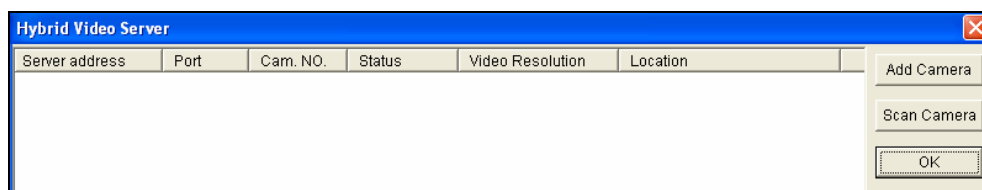

**Figure 1-117**

- To automatically set up an IP camera, click **Scan Camera** to detect any IP cameras on the same LAN. Note that the **Scan Camera** function only works for GeoVision IP products.
- To manually set up an IP camera, click **Add Camera**.

The following steps are the example of manual setup.

3. Click **Add Camera**. This dialog box appears.



**Figure 1-118**

4. Type the IP address, username and password of the IP camera. Modify the default HTTP port if necessary.
5. Select a camera from the Brand drop-down list. This dialog box appears. The options in the dialog box may vary depending on camera brands.

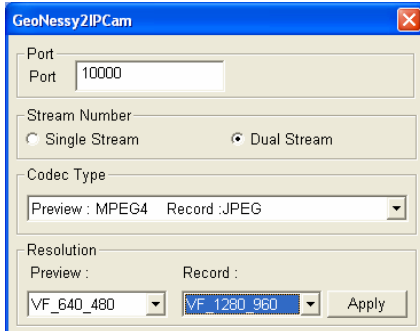

**Figure 1-119**

- **Port:** Video streaming port number.
  - **Stream number:** You may have the option of single or dual streaming.
  - **Codec Type:** You may have the codec option of MPEG4 or JPEG. If the selected camera supports dual streaming, the preview codec and recording codec can be set differently.
  - **Resolution:** You may select the different resolutions for preview and recording.
6. Click **Apply**. The IP camera is added to the list.
  7. Click the listed camera, and select **Display position** to map the IP camera to a channel on the GV-System.

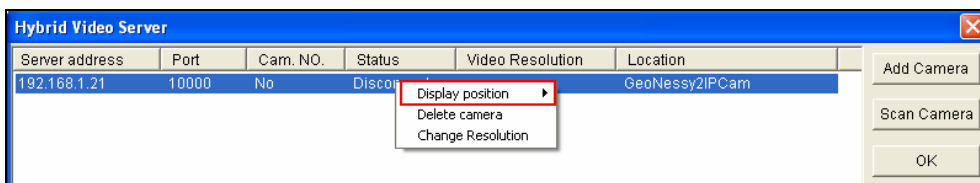
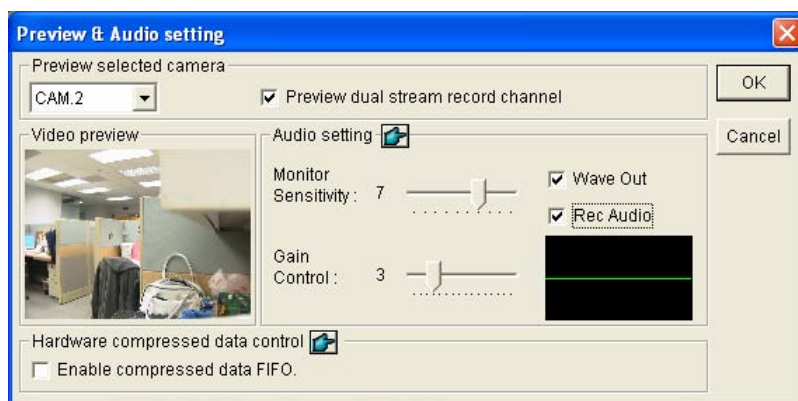

**Figure 1-120**

8. The Status column now should display *“Connected”*. Click **OK**.

## Previewing Video and Setting Audio

To preview video and activate audio, click the desired camera (Figure 1-121) and select **Preview & Audio Setting**. This dialog box appears.



**Figure 1-121**

### [Preview Channel Select]

- **Drop-down List:** Select the desired camera for live preview
- **Preview dual stream record channel:** The option is only available when the dual stream is set, i.e. the cameras for live view and recording are configured differently (see Figure 1-120). Check this option for recording preview.

### [Audio Setting]

- **Monitor Sensitivity:** Adjust the sensitivity of the audio that will be detected. The higher the value, the more sensitive the system is to the surrounding sound.
- **Gain Control:** Increase or decrease the gain of the microphone.
- **Wave Out:** Enable this option to listen to live audio from the camera.
- **Rec Audio:** Enable this option to activate the audio recording.

### [Hardware compressed data control]

The hardware-compressed data from the video IP device, such as IP Camera, Video Server and Compact DVR, will be transmitted directly to remote servers instead of being compressed again on GV-System. The remote servers include Center V2, Control Center and WebCam. This function is useful when many remote servers access GV-System at one time. It can reduce the system load on GV-System, and provide more frame rates and better image quality for each remote server.

---

**Note:** It is highly recommended to enable this function on a LAN environment because it requires a lot of bandwidth.

---

## Setting Up PTZ IP Camera

To set up the IP camera with PTZ functions, follow these steps:

1. To add the PTZ IP camera to the system, follow the steps in *Adding IP Video Sources* above.
2. To enable the PTZ function, click the **Configure** button (No. 14, Figure 1-2), point to **General Setting** and select **System Configure**. The System Configure dialog box appears.
3. In the PTZ Control section, enable **PTZ Device Setup** and select the PTZ IP camera from the drop-down list.
4. Click **OK** and return to the main screen. Now you should see **PTZ Control** button displayed on the right side of the main screen. Click this button to display the onscreen control panel.

For details on using the control panel, see *PTZ Control Panel* earlier in this chapter.

## Fast Key Lockup

If you wish not to use certain fast keys and do not want them to interfere with the keyboard use, you can disable the fast key functions.

1. Click the **Configure** button (No. 14, Figure 1-2), point to **Tools**, select **Tool Kit**, and then select **Fast Key Lock Setup**. This dialog box appears.

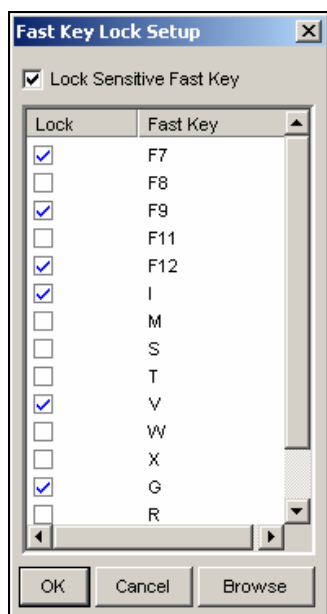

**Figure 1-122**

2. Check **Lock Sensitive Fast Key**, and check the fast keys you want to disable. To restore the fast keys, uncheck them again.
3. Click **OK** to apply your settings.

## Version Information

To know which version of GV-System you have, click the **Configure** button (No. 14, Figure 1-2), point to **Tools**, and then select **Version Information**.

## Fast Key Reference

This option lets you view the fast key windows of Main System and PTZ Control, giving you an instant reference. Click the **Configure** button (No. 14, Figure 1-2), point to **Tools**, select **Tool Kit**, and then select **Fast Key List** to display the fast key table of Main System. Click **Next** to display the table of PTZ Control.

## PTZ Protocol and Model Support

This list is for you to view the PTZ protocols and models that GV-System supports. When you set up PTZ control in the System Configure window, click the drop-down list to select the PTZ device.

PTZ Protocol and Model Support	
Ademco (Jupiter)	Minking Dome
Bosch (TC700 / 8560)	Mintron (54G2AHN/P)
CBC GANZ (ZC-S120 Series)	NanWang (NVD 2300PNT)
Chiper (V9KRP)	Panasonic (WV-CS850 / WV-CS960)
Direct Perception (PTU Series)	Pelco Dome (Pelco D / Pelco P)
D-max Dome	Pelco (Spectra III)
DongYang Dome (DOH-240)	PelcoSpetra Mini Dome (SD4-WO)
DynaColor (D-7720 / 7722)	Pishion 22X
Dynacolor Dome	PTZ in I/O
ELBEX (Matrix / 1000)	SAE (DR-E 588)
EverFocus (EPTZ 1000 / 500)	Samsung (SCC-641 / 643)
GKB (SPD-221)	Samsung (SPD-1600 / SPD-3300)
HiSharp HS-CC610 (Pelco D / Pelco P)	Sensormatic (Ultra IV)
JEC Dome	Sony (EVI-D100)
JVC (TK-S576B / TK-S655)	TOA (CC551)
Kalatel CyberDome	VCC3
Kampro Technology (K-ZC23)	VCC4
KenKo (DMP23-H1)	VCC50i
LG (LPT-OS553HQ)	VIDO Dome
Lilin PIH (PIH-7000 / 7600 / 7600PL / 7625)	YAAN Dome
MESSOA (SDS600 Series / D-700 Series)	

**Note:** GV-System only supports original factory models. Other brands of cameras claiming of the same protocol compatibility may not work properly with GV-System. GeoVision takes no responsibility of such incompatibility.

## USB Dongle Required for IP Device Applications

Solution	Application	USB Dongle Required
<b>Hybrid DVR</b>	Connection of GV IP devices to GV-System	NO
	Connection of 3 <sup>rd</sup> party IP devices to GV-System	NVR Dongle
<b>GV-NVR</b>	Connection of GV IP devices to GV-NVR	NVR (GV) Dongle
	Connection of both GV and 3rd party IP devices to GV-NVR	NVR Dongle
<b>Center V2</b>	Connection of GV IP devices to Center V2	No extra dongle required
<b>Control Center</b>	Connection of both GV and 3rd party IP devices to Control Center	No extra dongle required

## Supported IP Devices

No.	Model	No.	Model
1	GV-IP Camera	33	JVC_VN-C625U
2	GV-Video Server	34	JVC_VN-C655U
3	GV-Compact DVR	35	Mobotix_M12
4	Arecont_AV-1300	36	SONY_SNC_CS10
5	Arecont_AV-2100	37	SONY_SNC_CS11
6	Arecont_AV-3100	38	SONY_SNC_CS50N
7	Arecont_AV-5100	39	SONY_SNC_CS50P
8	AXIS_206	40	SONY_SNC_DF40N
9	AXIS_207 / AXIS_207W	41	SONY_SNC_DF40P
10	AXIS_207MW	42	SONY_SNC_DF50N
11	AXIS_210	43	SONY_SNC_DF50P
12	AXIS_211	44	SONY_SNC_DF70N
13	AXIS_211A	45	SONY_SNC_DF70P
14	AXIS_212 PTZ	46	SONY_SNC_DF80N
15	AXIS_213 PTZ	47	SONY_SNC_DF80P
16	AXIS_214 PTZ	48	SONY_SNC_P1
17	AXIS_216FD / AXIS_216FD-V	49	SONY_SNC_P5
18	AXIS_221	50	SONY_SNC_RX550N
19	AXIS_223M	51	SONY_SNC_RX550P
20	AXIS_225FD	52	SONY_SNC_RZ25N
21	AXIS_231D+	53	SONY_SNC_RZ25P
22	AXIS_232D+	54	SONY_SNC_RZ50N
23	AXIS_233D	55	SONY_SNC_RZ50P
24	IQEye_301	56	Panasonic_BB_HCM110
25	IQEye_302	57	Panasonic_BB_HCM311
26	IQEye_510	58	Panasonic_BB_HCM331
27	IQEye_511	59	Panasonic_BB_HCM371
28	IQEye_701	60	Panasonic_BB_HCM381
29	IQEye_702	61	Panasonic_BB_HCM403
30	JVC_VN-C20U	62	Panasonic_BB_HCE481A
31	JVC_VN-C205U	63	Panasonic_BL-C10
32	JVC_VN-C215U	64	Panasonic_BL-C30

Specifications are subject to change without notice.



## Specifications

Feature	Notes
<b>Panorama View</b>	<ul style="list-style-type: none"> <li>● Maximum of 16 channels</li> <li>● 4 sets of panorama view for live view monitoring</li> <li>● Dongle required</li> </ul>
<b>Defogging</b>	<ul style="list-style-type: none"> <li>● Maximum of 4 channels</li> <li>● Dongle required</li> </ul>
<b>Stabilizer</b>	<ul style="list-style-type: none"> <li>● Maximum of 4 channels</li> <li>● Dongle required</li> </ul>
<b>Counter</b>	<ul style="list-style-type: none"> <li>● Maximum of 16 channels</li> <li>● Frame rate must be 7 frames per second at least.</li> <li>● Using this function on 8 or more cameras requires memory of 512MB and a CPU of Pentium 4 Dual Core 2.13 GHz.</li> </ul>
<b>Privacy Mask</b>	<ul style="list-style-type: none"> <li>● Maximum of 16 channels</li> <li>● Maximum of 250 detection boxes can be set</li> <li>● The overall size of detection boxes cannot exceed 102400 bytes.</li> </ul>
<b>Advanced Motion Detection</b>	<ul style="list-style-type: none"> <li>● Maximum of 16 channels</li> <li>● Maximum of 10 detection boxes can be set at each sensitivity level</li> </ul>
<b>Object Index / Object Monitor / Face Detection</b>	<ul style="list-style-type: none"> <li>● Maximum of 4 channels</li> </ul>

Specifications are subject to change without notice.

# Chapter 2

---

I/O Applications .....	129
<b>Setting Up I/O Devices .....</b>	<b>129</b>
Latch Trigger .....	133
Keeping Last Toggle Status .....	135
<b>I/O Control Panel.....</b>	<b>137</b>
I/O Input Control Panel.....	137
I/O Output Control Panel.....	137
<b>Moving PTZ Camera to a Preset Location upon Alarm Event .....</b>	<b>138</b>
Deactivating Alarm and Alert Settings .....	139
<b>Detecting Input State.....</b>	<b>140</b>
<b>I/O Enable Setting .....</b>	<b>141</b>
<b>Advanced I/O Panel .....</b>	<b>142</b>
The Advanced I/O Panel.....	142
Creating a Group for Cascade Triggers.....	143
Configuring the Advanced I/O Panel.....	146
Setting Up Mode Schedule .....	147
Quick Link .....	149
Forcing Output .....	149
Editing Background Image.....	150
System-Wide Triggers.....	150
The “Advanced Logical Input Status in Mutlicam” Option.....	151
Managing a Group of I/O Devices.....	152
<b>Visual Automation .....</b>	<b>153</b>
Setting Up Visual Automation .....	153
Using Visual Automation.....	154
<b>Virtual I/O Control.....</b>	<b>155</b>
Setting Up a Module.....	156

## I/O Applications

This chapter discusses how you can set up and control the I/O devices connected to GV-System. I/O applications include these features:

- Configure I/O devices
- Move PTZ to a preset location on input trigger
- Support access control systems of Momentary and Maintained modes
- Arm and disarm I/O devices without interfering with the monitoring
- Centrally manage I/O devices across the wide area by the Advanced I/O Panel

## Setting Up I/O Devices

Devices necessary for I/O applications are: GV-Net, GV-Net card, GV-NET/IO card, GV-IO and GV-Relay. For details, see Chapter 2 in the *Installation Guide*.

To connect an I/O device to GV-System, you need to configure the settings. On the main screen, click the **Configure** button, point to **General Setting**, click **System Configure**, and then click the **I/O Device** tab. This window appears.

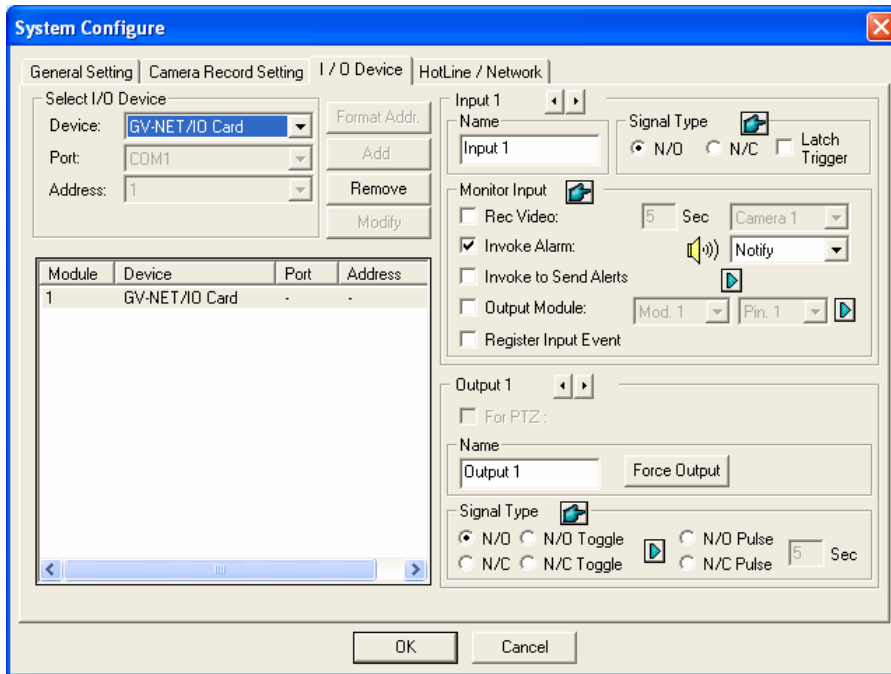

**Figure 2-1** I/O Settings

**[Select I/O Device]** Adds an I/O device to the system:

1. Select the device from the **Device** drop-down list.
2. Click the **Format Addr.** button to assign an address to the device. The Format Address dialog box appears.
3. Start your first device with **New Address** set to 1. Click the **Write** button to write the address to the device. Click **OK** to apply the setting.
4. Click the **Add** button. You should see the device listed in the display window.

---

**Note:**

- Repeat above steps to add more devices once at a time. Each device should have its own address; therefore, in step 3 you should assign a different address for the new device.
  - For GV-Net/IO Card V3.1 (Net/IO Card Mode), select the port option of **GV-NET/IO Card**; for GV-Net/IO Card V3.1 (I/O Box Mode), select the port option of **GVIO-USB(4)**; for GV-I/O USB Box, select the port option of **GVIO-USB(16)**.
-

**[Input X]** Click the **Arrow** buttons to select an Input to set up. One GV-IO module provides up to 8 inputs.

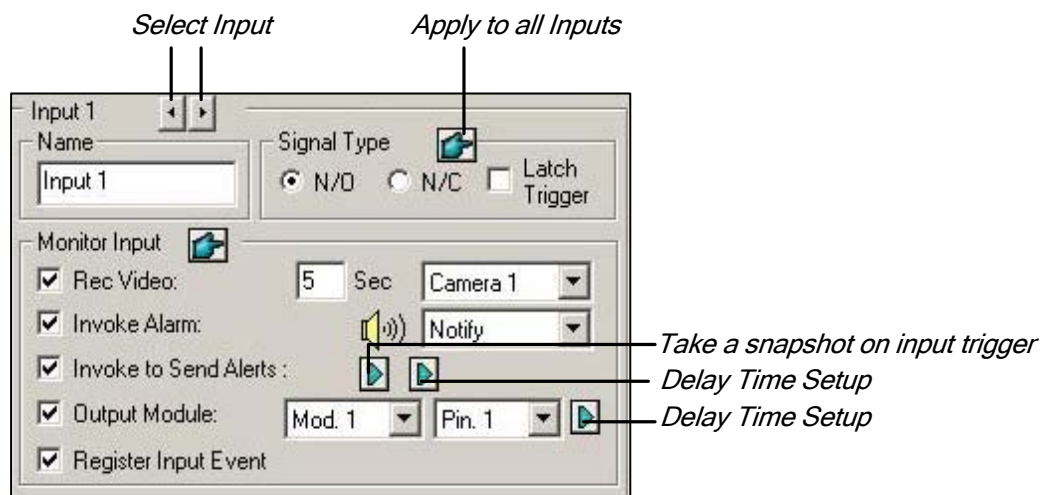

**Figure 2-2**

- **Name:** Specifies a name for each input device in the Name field. (Click the **Arrow** button to set up next input).
- **Signal Type:** Select signal type for your input device. You may use the **Finger** button to apply your selection to all input devices.

For details on Latch Trigger, see *Latch Trigger* later in this chapter.

#### **[Monitor Input]**

- **Rec Video:** Check this option to use the input (sensors or detectors) to trigger recording. You may select which camera to record in the Camera Select drop-down list and specify the recording duration.
- **Invoke Alarm:** Check this option to activate computer alarm when the input is triggered. You may select the alarm type in the drop-down menu.
- **Invoke to Send Alerts:** Check this option to send out an assigned alert (E-Mail/Hotline/SMS) when the input is triggered.

**1st Right Arrow button:** Appears when E-Mail is the assigned alert. Click to select the camera(s) to take a snapshot on input trigger. The snapshot will be sent out by E-Mail.

**2nd Right Arrow button:** Click to set the delay time to activate assigned alerts (E-Mail/Hotline/SMS).

- **Output Module:** If the input is invoked, the system will automatically send a signal to an output pin.

**Right Arrow button:** Click to set the delay time to activate the assigned output module.

- **Register Input Event:** This option logs the alarm events into System Log. Each event is labeled with ID, time, device name (camera or I/O input), corresponding module of the device, and event for later retrieval. For details on *System Log*, see Chapter 1.

**Note:** The delay functions in **Invoke to Send Alerts** and **Output Module** allow you time to deactivate prior to enabling alerts and the output device. To deactivate these settings, you may stop monitoring or enable the assigned input module set at “**Deactivate notification when selected pin ON**” in I/O Application window (Figure 2-8).

**[Output X]** Click the **Arrow** buttons to select an output. One GV-IO module provides up to 16 outputs.

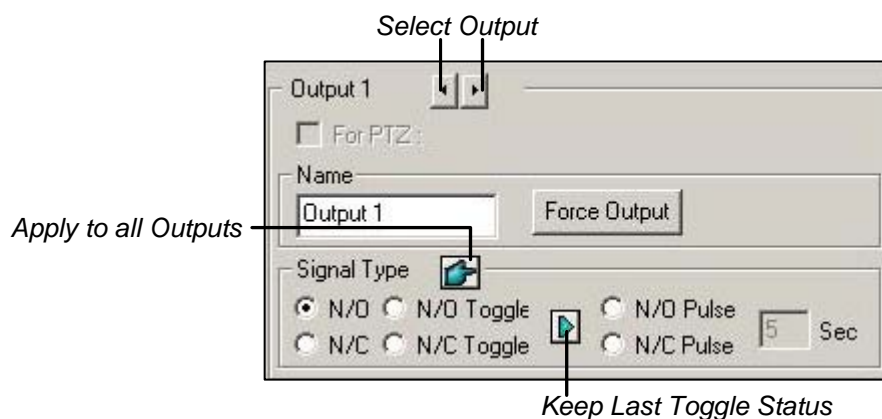

**Figure 2-3**

- **For PTZ:** This option opens the PTZ Control Panel, where to control movements of your PTZ camera.
- **Name:** Specifies a name for each output device in the Name field.
- **Force Output:** Click to test signal to the selected device.
- **Signal Type:** There are six signal types available: N/O (Normal Open), N/O Toggle, N/O Pulse, N/C (Normal Closed), N/C Toggle, and N/C Pulse. Choose the one that mostly suits the device you’re using. The N/O Toggle or N/C Toggle signal type is the output high mode that turns to output low until the monitoring is stopped. You can also specify the pulse duration for pulse type signals.
- **Keep Last Toggle Status:** See *Keeping Last Toggle Status* later in this chapter.

**Note:** PTZ camera and I/O devices cannot be assigned to the same port at the same time.

## Latch Trigger

Instead of constant output alarm in N/O and N/C, the Latch Trigger option provides a momentary alarm, and allows you to set the alarm duration.

### Setting up Latch Trigger:

On the main screen, click the **Configure** button, point to **General Setting**, click **System Configure**, click the **I/O Device** tab, and then check **Latch Trigger**. See the red square in this dialog box.

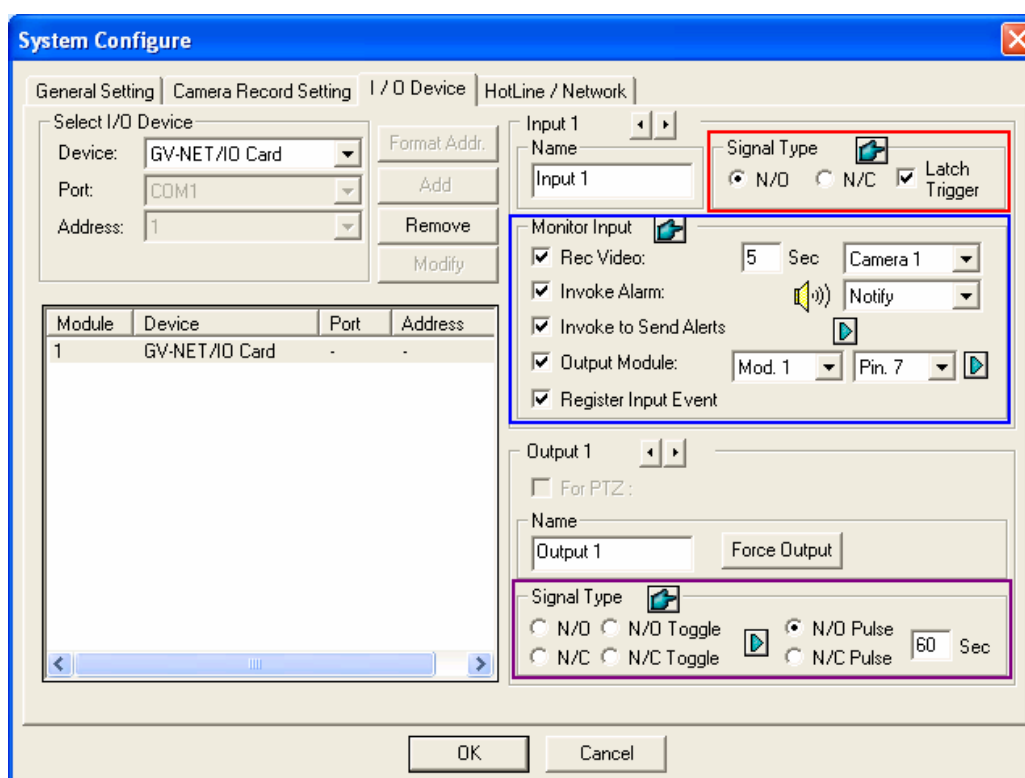

Figure 2-4

### Application Example:

In the above scenario, Input 4 is set to N/O and Latch Trigger as well. When Input 4 is triggered:

- Camera 1 starts recording for 30 seconds and stops itself until the next input trigger (see the Rec Video option).
- Computer Alarm sounds once (see the Invoke Alarm option).
- The output (Module 3, Pin 7) is triggered simultaneously based on the Latch Trigger mode (see the illustrations below).

Following illustrations can help you understand different output signals (see Purple Square in the above dialog box) working with the Latch Trigger option.

### 1. N/O (Normal Open) + Latch Trigger

Once the input triggers the output, the output will be triggered for a short moment and then turn off itself.

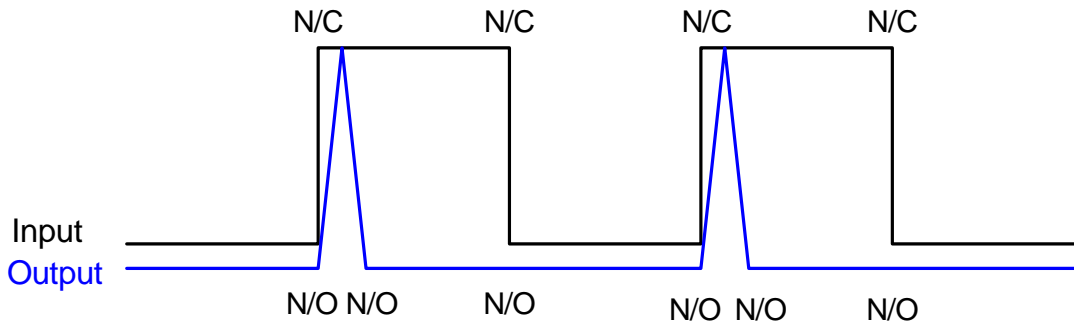

### 2. N/O Toggle + Latch Trigger

Once the input triggers the output, the output will keep triggering until a new input trigger.

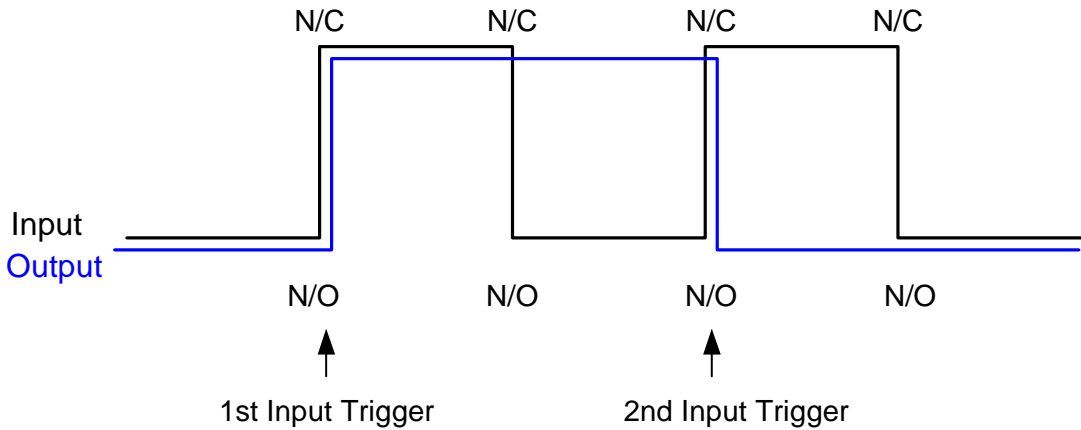

### 3. N/O Pulse + Latch Trigger

Suppose you set the Pulse time to 60 second. Once the input triggers the output, the output will remain ON for 60 seconds before turning off itself.

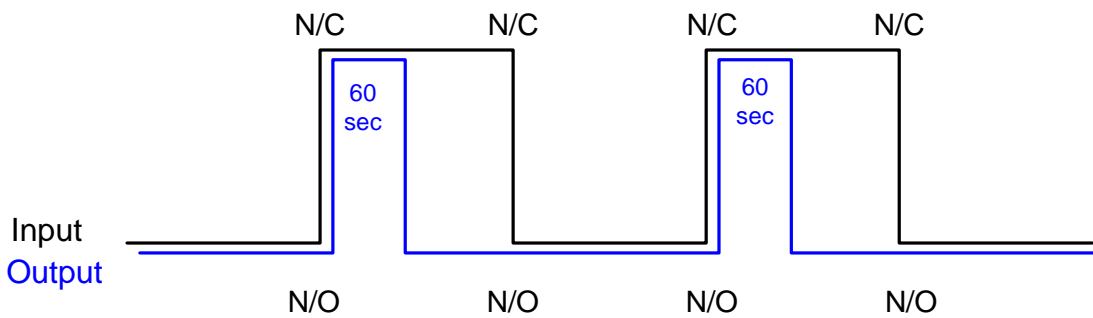



## Keeping Last Toggle Status

This feature can memorize the current output state when the monitoring is stopped or the system is restarted. For example, suppose the output is lights. When remaining on the premises, you stop monitoring but the triggered lights remain ON, not affected by the system state.

### Setting up “Keep Last Toggle Status”:

In the System Configure dialog box (Figure 2-3), select **N/O Toggle** or **N/C Toggle**, click the **Arrow** button beside to check **Keep Last Toggle Status**.

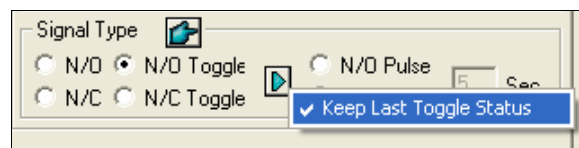

Figure 2-5

### Application Example:

Following two illustrations help you understand how the input works with the output set to **Keep Last Toggle Status**.

#### 1. Input (N/O) + Output (N/O Toggle + Keep Last Toggle Status)

The triggered output remains ON even when you stop monitoring or restart the system.

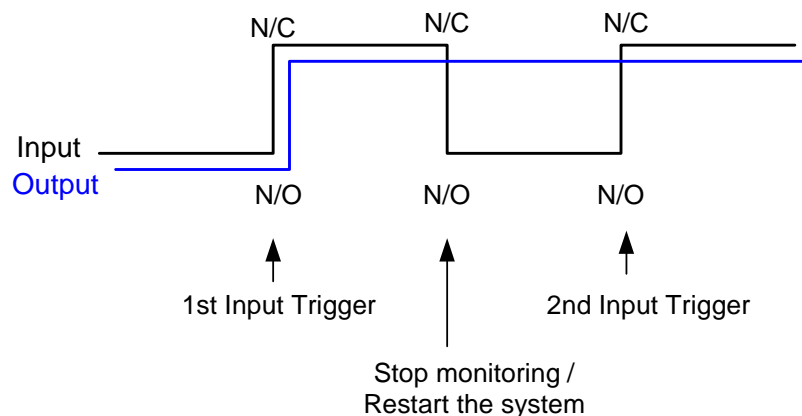

## 2. Input (N/O + Latch Trigger) + Output (N/O Toggle + Keep Last Toggle Status)

When “Latch Trigger” works with “Keep Last Toggle Status”, the output only has a momentary trigger but also needs to remain ON even when you stop monitoring or restart the system. Therefore under the two conditions, the output turns off until a new input trigger.

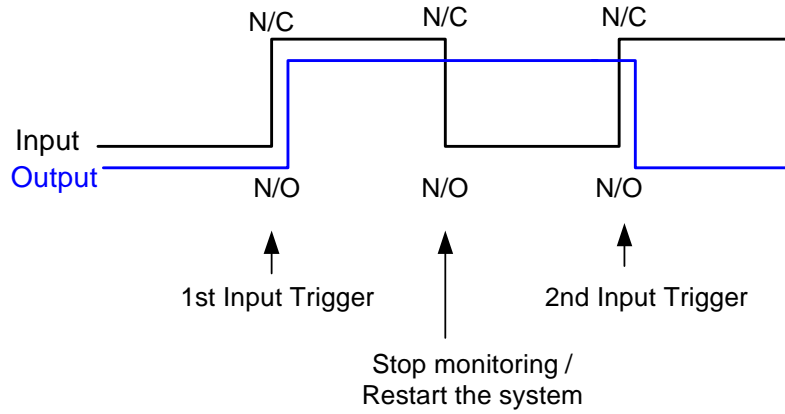

## I/O Control Panel

I/O control panel is used to control I/O devices that are added to the system. This control panel will not appear, unless at least one I/O device is connected to the system. To add and to configure a device, see *Setting Up I/O Devices* earlier in this chapter.

### I/O Input Control Panel

After a device is added to the system, click the **I/O** button on the main screen to bring out the on-screen control panel for inputs and outputs (Figure 2-6 and Figure 2-7). If only one I/O device is connected to the system, click the **I/O** button and select **Module 1** to bring up the control panel; if more than one I/O modules are connected to the system, clicking the **I/O** button will list all I/O modules connected to the system. Select one to bring out the control panel.

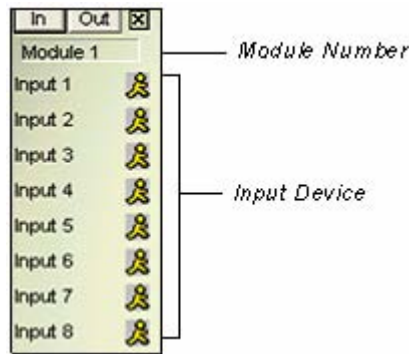

Figure 2-6 Input control panel

The input panel displays status of current input sensors. The “walking man” icon indicates the sensor is being triggered.

### I/O Output Control Panel

Click the **Out** button to switch to the following output panel. Pressing an alarm icon will send an output signal to the corresponding relay.

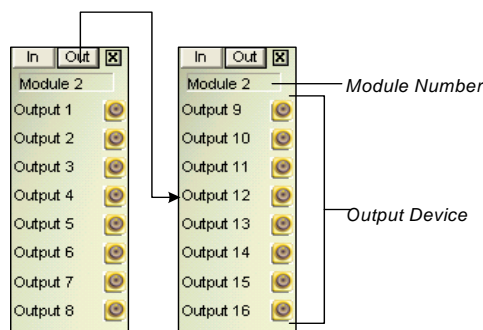
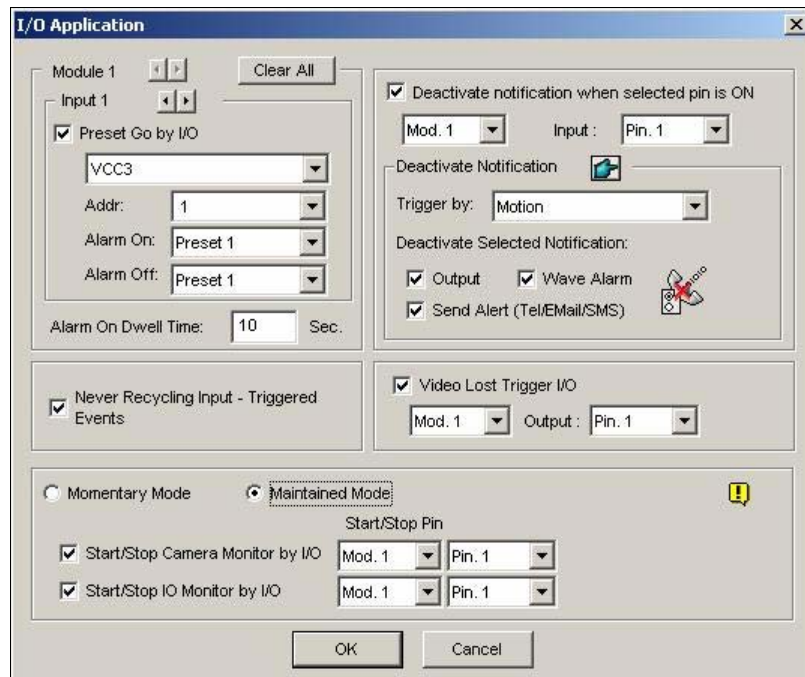

Figure 2-7 Output Control Panel

## Moving PTZ Camera to a Preset Location upon Alarm Event

It is possible to direct a PTZ camera to a present location upon an alarm event. The setup determines how the PTZ camera moves to respond to an I/O-triggered event. Click the **Configure** button, point to **Accessories**, click **I/O Application**, and select **I/O Application Setting** from the menu to bring up the following dialog box.



**Figure 2-8** I/O Application

The options here allow you to specify how the PTZ camera, and the GV-System will respond to an I/O-triggered event. Click the **Arrow** buttons, and select a **module** and its **input** to set up.

- **Preset Go by I/O:** Enable the option and select your PTZ camera from the drop-down list.
- **Addr:** Specify the address of the PTZ camera.
- **Alarm On:** Turns the PTZ camera to a preset point when the input is triggered.
- **Alarm Off:** Returns the PTZ camera to a preset point when the triggered input is off.
- **Alarm On Dwell Time:** Specify the amount of time the PTZ camera stays at “Alarm On” preset point, before returning to the “Alarm Off” preset point.

**[Never Recycling Input-Triggered Events]** When the item is checked, the files of input-triggered events won't be recycled by the system when disk space is full.

**[Video Lost Trigger I/O]** Activates the specified output module if any camera loses its video signal.

**[Momentary Mode]** Pushbutton switches that are normally open and stay closed only as long as the button is pressed. Momentary switches allow turn-on or turn-off from multiple locations. For example, certain premises have a designated entry/exit door. When the staff enters the entry door, the system starts monitoring. When the staff leaves from the exit door, the system stops monitoring.

**[Maintained Mode]** Push-on/push off button switches that stay open until thrown, and then stay closed until thrown again. Maintained switches are convenient for only one switch location.

For example, in the business hour when the door is opened, the system stops monitoring; in the non-business hour when the door is closed, the system starts monitoring.

## Deactivating Alarm and Alert Settings

The option lets you instantly deactivate all the prior alarm and alert settings (Output, Wave Alarm, Send Alerts), when an assigned input module is triggered. Open the I/O Application window (Figure 2-8), and find the following section.

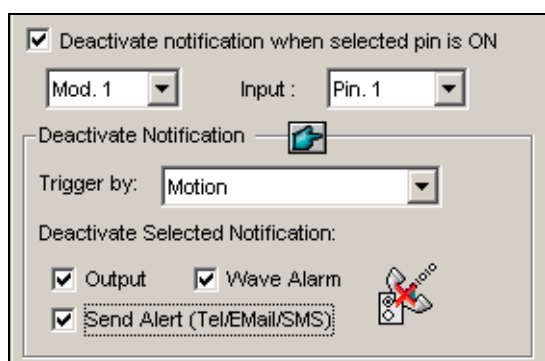

**Figure 2-9**

**[Deactivate notification when selected pin is ON]** When an assigned input module is activated, all designated alarms and alerts will be disabled. Assign an installed input module and a pin number for the application.

### **[Deactivate Notification]**

- **Triggered by:** Select an alert condition from the drop-down list for the application. For example, if you choose Motion, all designated alarms and alerts upon motion detection will be deactivated when an assigned input module is activated.
- **Deactivate Selected Notification:** Select the alarms and alerts you want to be deactivated, such as Output, Wave Alarm and/or Send Alert, when the assigned input module is activated.

## Detecting Input State

This feature is designed to monitor all inputs for a change of state whenever you start I/O monitoring. A change from the defined state (N/O to N/C or N/C to N/O) can activate an alarm condition, e.g. a warning light or buzzer.

1. On the main screen, click the **I/O** button, and then select **Detect Input Status**. This dialog box appears.

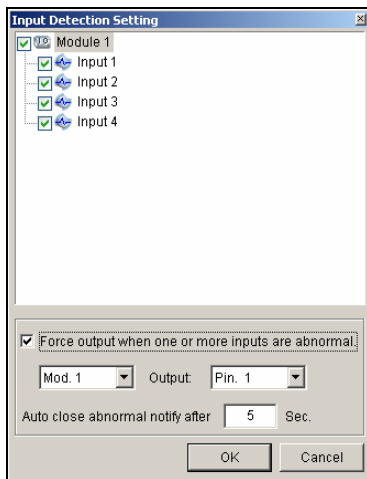

**Figure 2-10**

2. Check the Input(s) you want to monitor.
3. For any state change, you can trigger an alarm output by checking **Force Output when one or more inputs are abnormal**, and assigning the output module and pin number.
4. When the state change is detected, a warning message will pop up on the screen. In the **Auto close abnormal notify after x sec** field, you can define the duration of the message to close itself automatically.

After settings, you can manually detect all input states by selecting **Detect Input Status**. Or, you can just start I/O monitoring. When the system detects any change of input state, you may see this warning message:

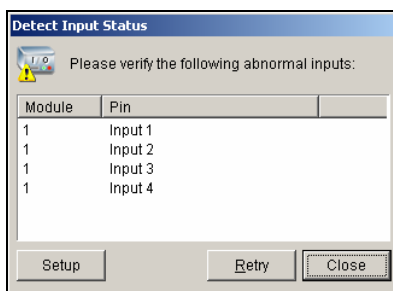

**Figure 2-11**

## I/O Enable Setting

You can manually arm or disarm any I/O devices without interrupting the monitoring. For example, when an output alarm is triggered at the front door, you can turn off the output while the system keeps on recording and I/O monitoring.

### Arming / Disarming I/O devices:

1. On the main screen, click the **I/O** button, and select **I/O Enable Setting**. This dialog box appears.

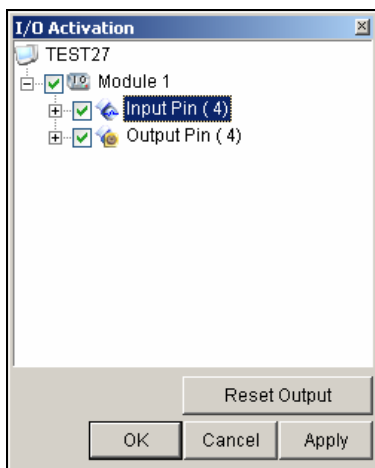

**Figure 2-12**

2. Check the Input/Output to arm or uncheck the Input/Output to disarm the device(s). Then click **Apply** to verify the changes.

## Advanced I/O Panel

The Advanced I/O Panel provides a centrally managing solution for I/O devices installed across a wide area. It simplifies the process of configuring and managing many I/O devices. Its major features are:

- Trigger I/O devices without starting I/O monitoring
- Group I/O devices for cascade triggers
- Monitor different I/O cascade configurations at different times of the day
- Quickly access triggered I/O devices by a Quick Link window

### The Advanced I/O Panel

To open the panel, click the **I/O** button on the main screen, and then select **Advanced I/O Panel**.

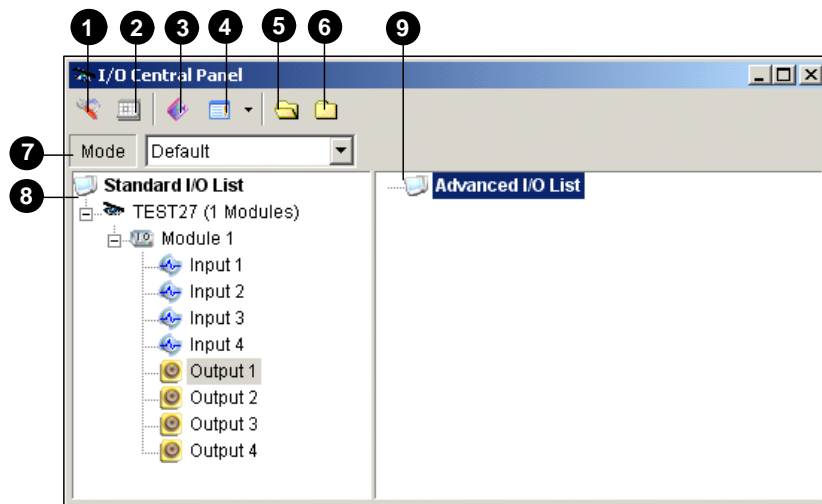

**Figure 2-13**

The controls on the Advanced I/O Panel:

No.	Name	Description
1	Configure	Accesses Panel and Schedule settings.
2	Mode Schedule	Starts/stops Mode Schedule.
3	Toggle Quick Link	Displays the Quick Link window for quick access to triggered I/O devices.
4	Advanced I/O List Style	Displays the Advanced I/O List in various styles: View/Edit, Icon and Detail.
5	Expand Tree Row	Expands tree branches.
6	Collapse Tree Row	Collapses tree branches.
7	Mode	Configures various cascade modes.
8	Standard I/O List	Displays connected I/O modules.
9	Advanced I/O List	Groups I/O devices in cascade mode.



## Creating a Group for Cascade Triggers

You can group I/O devices by function or geography. Further, the group allows cascade triggers, meaning that the trigger actions of one trigger can activate another trigger.

For example, you might have a group called “Entrance” that contains all I/O devices installed at entrances. The “Entrance” group might contain other sub groups, each of which contains just the related I/O devices in various geographic locations:

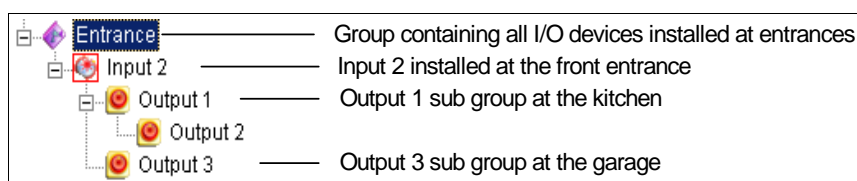
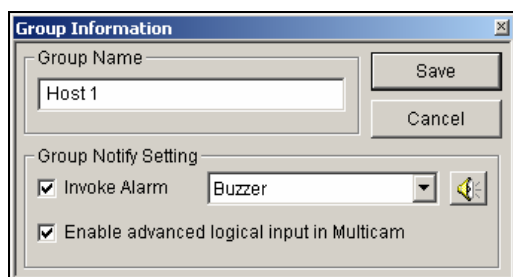

**Figure 2-14**

When Input 2 is triggered, it will trigger the sub groups of Output 1 and Output 3, and Output 1 will trigger Output 2 in a cascade series.

### Creating a Group:

1. Right-click on **Advanced I/O List**, and then select **Add A Group**. This dialog box appears.



**Figure 2-15**

- **Group Name:** Names the group.
  - **Invoke Alarm:** Invokes the computer alarm on I/O trigger. Select a sound from the drop-down list.
  - **Enable advanced logical input in Multicam:** See *Setting Advanced Logical Input Status* later in this chapter.
2. Click **Save** to apply the settings, and return to the panel.
  3. To create a cascading hierarchy, drag the desired inputs/outputs from the left **Standard I/O List** to the group.

---

**Note:** In the cascading hierarchy, each input can only be used once while the same output can be used repeatedly.

---

## Editing a Group:

To modify group settings, right-click a group, and select **View/Edit**. This dialog box appears.

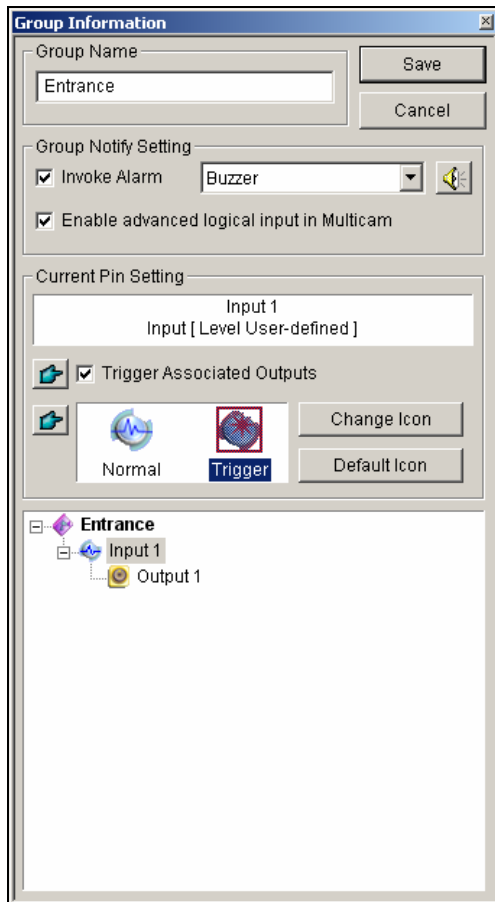

**Figure 2-16**

**[Group Name]** As described in Figure 2-15.

**[Group Notify Setting]** As described in Figure 2-15.

**[Current Pin Setting]** To enable this option, highlight an I/O device from the group list at the bottom.

- **Trigger Associated Outputs:** Triggers outputs in cascade mode. Click the **Finger** button to apply the change to all I/O devices at the same group.
- **Change Icon:** To enable this option, select one of two displayed icons: Normal or Trigger. Click the **Change Icon** button to change an icon. Click the **Finger** button to apply the change to all I/O devices at the same group.

## Editing an I/O Device

In addition to editing groups, you can also edit the settings of individual I/O device. Right-click an I/O device, and select **Setting**. This dialog box appears.

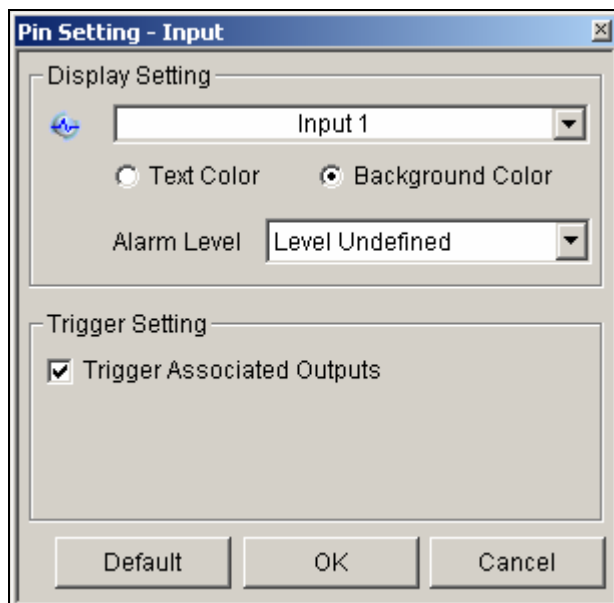

**Figure 2-17**

**[Display Setting]** You can define the nature of I/O devices by colors. Note that the setting only affects the **Detail** style of the Advanced I/O List (No. 4, Figure 2-13).

- **Alarm Level:** Click the **Alarm Level** drop-down list, and select one of the six default colors: Fire, Smog, Vibration, Intruder, Motion and Emergency. For the Level Undefined option, select **Text Color** or **Background Color**, and then click the Input/Output drop-down list to change its color.

### **[Trigger Setting]**

- **Trigger Associated Outputs:** Triggers outputs in cascade mode (see *Creating a Group for Cascade Triggers* above).

## Configuring the Advanced I/O Panel

On the panel toolbar, click the **Configure** button, and select **Panel Setting**. This dialog box appears.

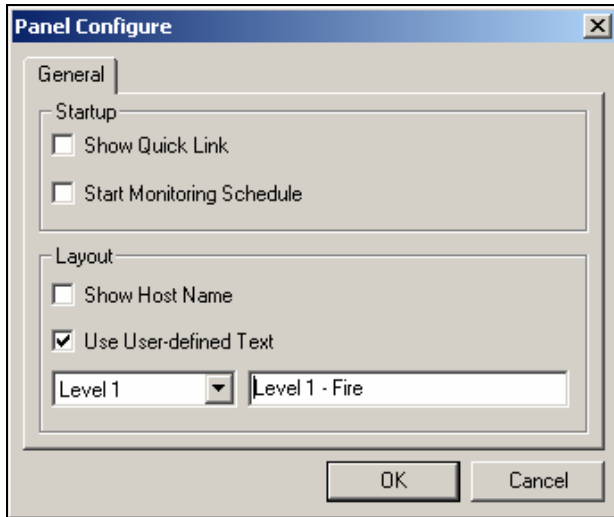

**Figure 2-18**

### [Startup]

- **Show Quick Link:** Opens the Quick Link window at panel startup.
- **Start Schedule Monitoring:** Starts Mode Schedule at panel startup. For details, see *Setting up Mode Schedule* below.

### [Layout]

- **Show Host Name:** Displays the host name of each I/O device on the Advanced I/O List.
- **Use User-defined Text:** Allows you to modify the text of Alarm Level (Figure 2-17).

## Setting Up Mode Schedule

The Mode Schedule allows you to monitor different I/O cascade configurations at different time. For example, you may want I/O cascade triggers one way during business hours and another way for non-business hours. Modes can be switched automatically at a scheduled time.

### Creating a Mode:

1. Click the Mode drop-down list (No. 7, Figure 2-13), and select **More Edit**. This dialog box appears.

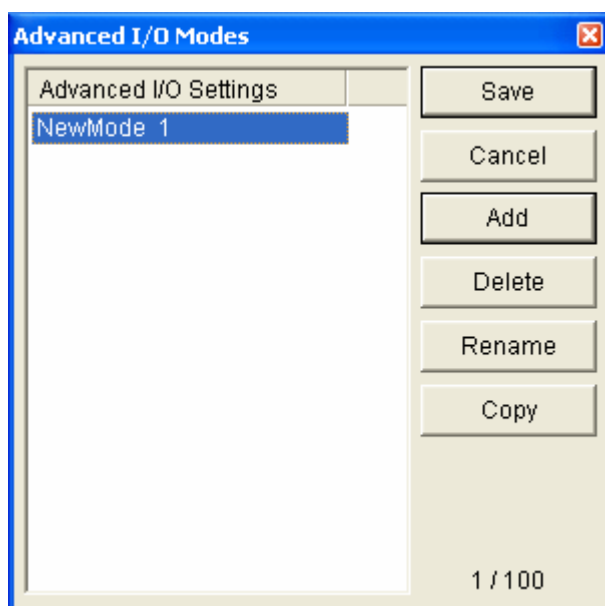

**Figure 2-19**

2. Click **Add**, and name the created mode. You can create up to 100 modes.
3. You can also apply the settings of the existed mode to the newly created mode. Click **Copy**, and select **from Default** to create a mode of default settings, or **select from selected Mode** to create a mode using the settings of the previously created mode.
4. Click **Save** to return to the panel.
5. Select the created mode from the **Mode** drop-down list, and create the groups in the Advanced I/O List. For details, see *Creating a Group for Cascade Triggers*.

## Creating a Mode Schedule:

Define the times and days you like the panel to switch modes.

1. On the panel toolbar, click the **Configure** button, and select **Schedule Setting**. This dialog box appears.

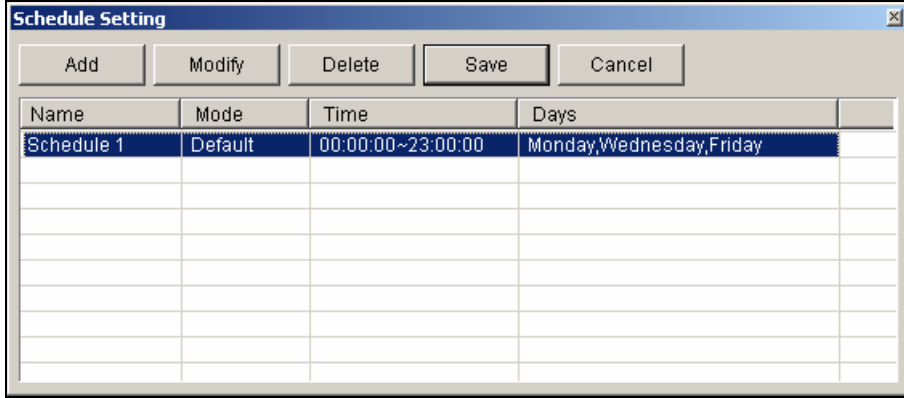

**Figure 2-20**

2. Click **Add** to create a schedule. This dialog box appears.

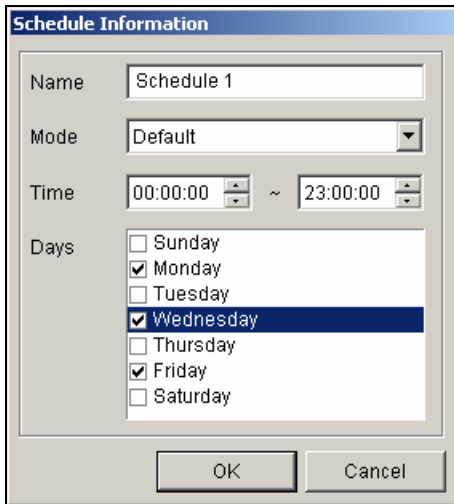

**Figure 2-21**

- **Name:** Type a name for the schedule.
- **Mode:** Select a mode from the drop-down list.
- **Time:** Define a time period you want the mode to run.
- **Days:** Check the day(s) you want the mode to run.

3. Click **OK** to apply the settings, and click **Save** to return to the panel.
4. To start the mode schedule, click the **Mode Schedule** button (No. 4, Figure 2-13), and then select **Mode Schedule Start**.

## Quick Link

The Quick Link provides a quick access to triggered I/O devices. It is a separate window to display all group icons. The group icon flashes when any included I/O device is triggered. Clicking the flashing icon will bring you to the I/O location in the Advanced I/O List.

- To open the Quick Link window, click the **Toggle Quick Link** button. (No. 3, Figure 2-13).
- To set the Quick Link window at panel startup, see the **Show Quick Link** option in Figure 2-18.

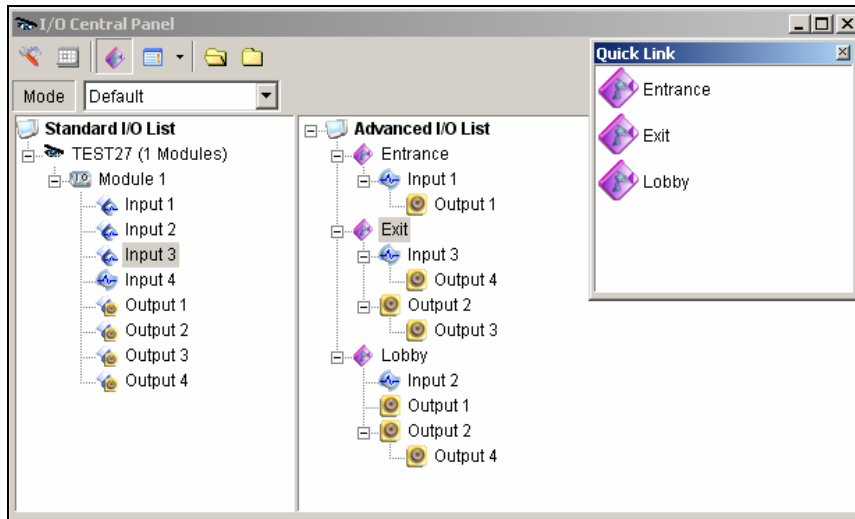

Figure 2-22

## Forcing Output

To manually force an output, click one output, and select **Force Output**.

- In the Standard I/O List, you can force the output individually.
- In the Advanced I/O List, considering cascade triggers, you can only manually force the output at the top level, e.g. Figure 2-23. Other outputs at sub levels cannot be forced manually, e.g. Figure 2-24.

However, if the output is not in a cascading hierarchy, you can definitely force it manually, e.g. Figure 2-25.

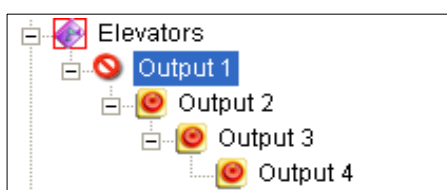

Figure 2-23

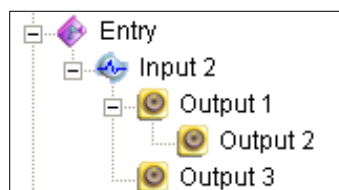

Figure 2-24

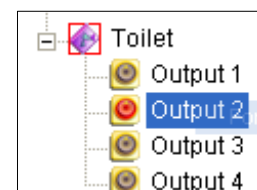
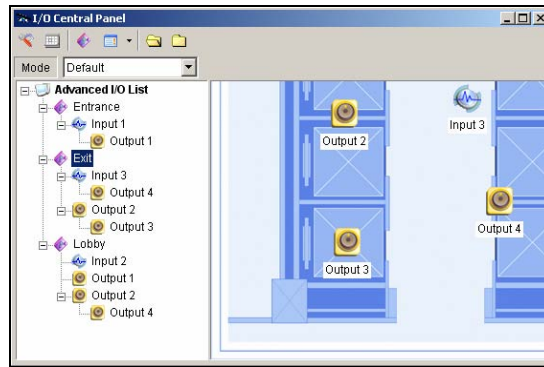

Figure 2-25

## Editing Background Image

With the Background Image feature, you can import a floor plan to lay out the locations of triggered I/O devices. This feature works in the **Icon** style of the Advanced I/O List.

1. To switch to the Icon style, click the **Advanced I/O List Style** button (No. 4, Figure 2-13) and then select **Icon**.
2. Select a group in the Advanced I/O List. The I/O icons of this group will be displayed.
3. Right-click on the right screen, and select **Background Image** to import a graphic file.
4. Right-click on the right screen, and uncheck **Auto Arrange**. Now you can freely drag the I/O icons to the desired locations on the imported map.
5. To add images to another group, repeat the steps 2 to 4.



**Figure 2-26**

---

**Note:** Highlighting **Advanced I/O List** in the Advanced I/O List, you can import another image.

---

## System-Wide Triggers

The System-Wide feature gives privileges to remote applications, such as Center V2 and VSM, to force the outputs in the Main System for cascade triggers.

For this example, the System-Wide feature is enabled in Output 1. When the VSM operator manually forces Output 1, Output 2, 3 and 4 will be triggered in a cascade series. If the System-Wide feature is disabled, the operator can only force Output 1 without cascade triggers.

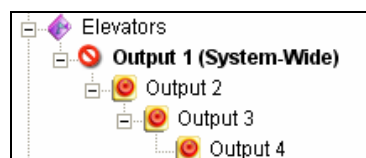

**Figure 2-27**

To enable this feature, right-click an output at the top level, and then select **System-Wide Output**.



## The “Advanced Logical Input Status in Mutlicam” Option

If you already set a specific input to trigger a specific output in the Main System, you can decide whether to apply the simple input-trigger-output setting in the Advanced I/O Panel.

For example, you have set a simple access system in the Main System: Input 2 (card reader) triggers Output 3 (the door opens).

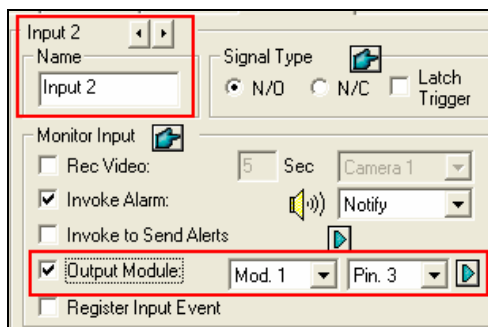

**Figure 2-28**

But to tighten security, you may set a group “Garage” in the Advanced I/O Panel. Both Input 1 (power switch) and Input 2 (card reader) should be activated together to trigger Output 1 (light), Output 2 (alarm) and Output 3 (the door opens) in a cascade series. Simply activating Input 2 (card reader) shouldn’t cause any output triggers in the cascading hierarchy.

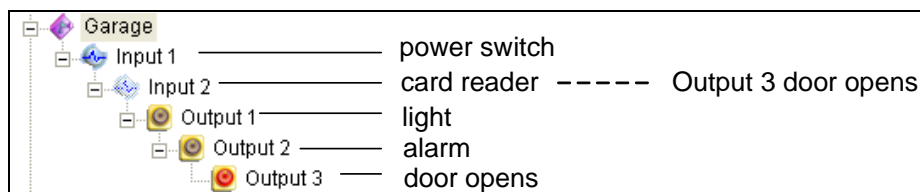

**Figure 2-29**

So now you have the options:

- At default, the simple input-trigger-output setting is applied at the Advance I/O Panel when **I/O monitoring** is activated. For this example, Input 2 will trigger Output 3.
- To only apply the cascade triggers set in the Advanced I/O Panel and ignore the simple input-trigger-output setting, enable **Use adv. Logical input result as input status** from the I/O icon on the main screen and **Enable advanced logical input in Multicam** from a certain group (see Figure2- 16) together.
- To switch to the simple input-trigger-output setting, just disable **Enable advanced logical input in Multicam**.

## Managing a Group of I/O Devices

With groups of I/O devices set up on the I/O Advanced Panel, you can enable or disable these I/O devices by groups.

### Enabling a Group

On the I/O Advanced Panel, right-click a desired group and select **Start Monitoring**. All input devices of this group are now enabled. When inputs are triggered, outputs will be activated in cascade mode.

### Disabling a Group

On the I/O Advanced Panel, right-click a desired group and select **Stop Monitoring**. All input devices of this group are now disabled. No cascade triggers will occur.

### Pausing the Triggered Inputs

This feature is designed for a group of outputs set to be Toggle mode. When inputs activate outputs in cascade triggers, right-click this group and select **Pause Monitoring**. The inputs of the group will be reset, but the outputs keep on alarming.

---

**Note:** With the **System-Wide Output** option (see *System-Wide Triggers* above) activated, you cannot use these three options to manage a group of I/O devices.

---

## Visual Automation

The Visual Automation helps you automate any electronic device by triggering the connected output. You can intuitively click on the image of the electronic device to change its current state, e.g. light ON.

### Setting Up Visual Automation

1. On the main screen, click the **Configure** button, point to **Accessories**, and select **Visual Automation Setting**. This dialog box appears.

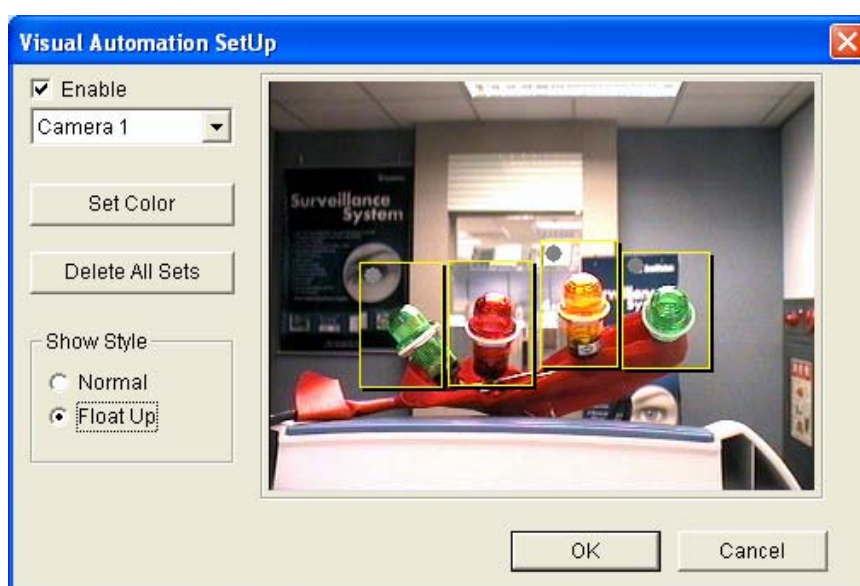

**Figure 2-30**

2. Select the desired camera from the drop-down list, and check **Enable**.
3. Drag the region on the image of the desired device. This dialog box appears.

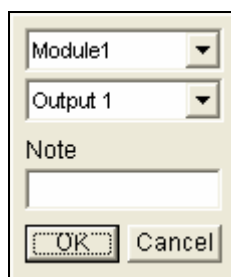
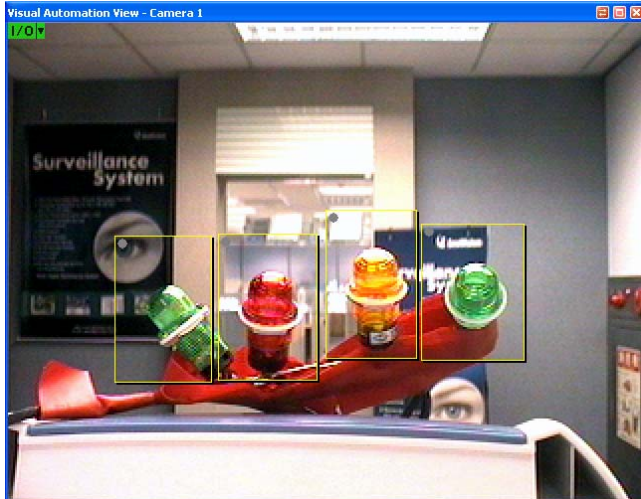

**Figure 2-31**

4. Select the connected module and output device. In the Note field, type a note to help you manage the device. Click **OK** to save the configurations.
5. To change the frame color of the set region, click the **Set Color** button.
6. To emboss the set region, check the **Float Up** option; or keep them flat by checking the **Normal** option.

## Using Visual Automation

1. On the main screen, click the desired camera name, and select **I/O Automation**. This window appears.



**Figure 2-32**

2. Click the set regions to force the connected output device.
3. To change the style of the set region, right-click the **I/O** icon to bring up these options:
  - **Show All:** Displays all set regions.
  - **Rect Float:** Embosses all set regions.
  - **Set Color:** Changes the frame color of all set regions.

## Virtual I/O Control

The GV-System can work with the GV-Video Server, GV-Wiegand Capture, GV-Compact DVR and GV-IP Cameras. The integration allows the GV-System to control their connected I/O devices respectively.

On the main screen, click the **Configure** button, point to **Accessories**, click **I/O Application**, and then select **Virtual I/O Setting**. This dialog box appears. The I/O device settings are similar to those of the Main System. For details, see *Setting Up I/O Devices* earlier in this chapter.

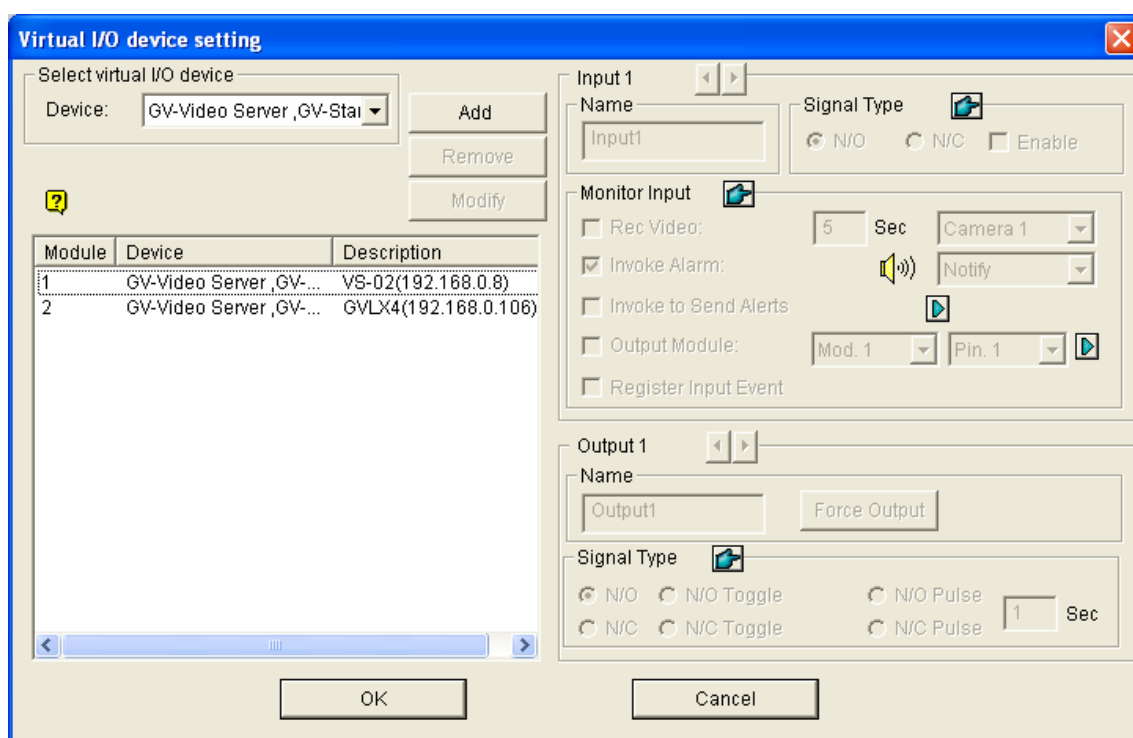
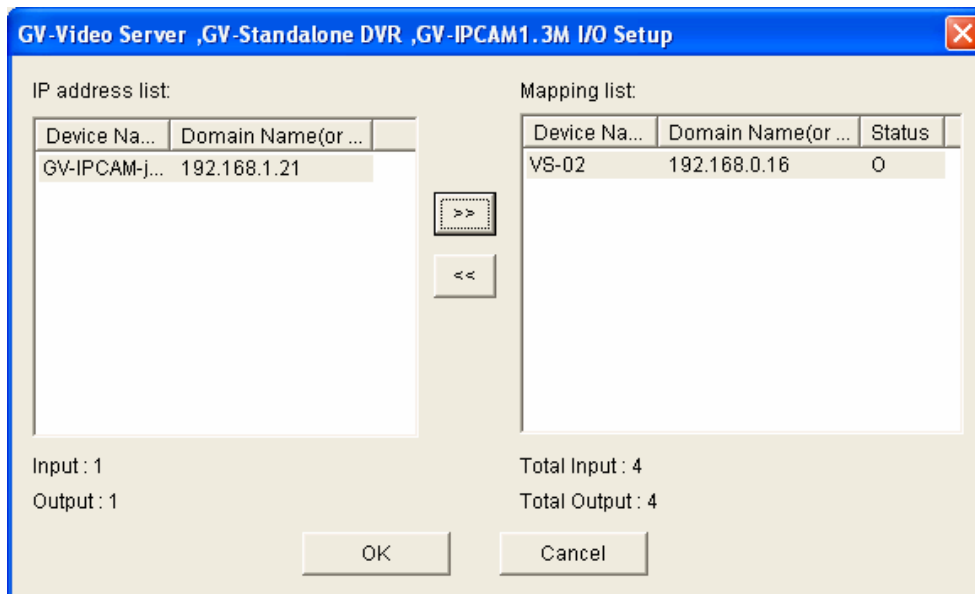

Figure 2-33

## Setting Up a Module

Up to 16 connected I/O devices can be combined to be one module for the GV-System to use. Note that I/O devices from GV-Video Server, GV-Compact DVR and GV-IP Camera can be combined to build a module. However, I/O devices of GV-Wiegand Capture can only combine with those of another GV-Wiegand Capture to set up a module.

1. Establish the connection to GV-Video Server, GV-Wiegand Capture, GV-Compact DVR or GV-IP Cameras. For details, see *Hybrid and NVR Solution* in Chapter 1.
2. In the Virtual I/O Device Setting dialog box (see Figure 2-33), select one device, e.g. **GV-Video Server**, **GV-Comact DVR**, **GV-IP CAM 1.3M I/O**, and then click the **Add** button. This dialog box appears.



**Figure 2-34**

3. The connected devices appear on the IP address list. Select the desired devices and click the [**>>**] button to add their I/O devices to the Mapping list. The total number of added I/O devices is displayed at the bottom of the Mapping list. Click **OK**.
4. Select the added module from the list, and define the input status in the Monitor Input section. For details, see *[Input x], Setting Up I/O Device*, earlier in this chapter. Click **OK**.
5. On the main screen, click the **I/O** button. This module is available from the selection list.

# Chapter 3

---

Point-Of-Sale (POS) Application.....	158
<b>POS System Connection</b> .....	<b>158</b>
POS Data Sender .....	159
<b>Setting a POS System</b> .....	<b>160</b>
<b>Superimposing POS Data onto Camera Screen</b> .....	<b>162</b>
<b>POS Field Filter</b> .....	<b>164</b>
<b>Abnormal Transaction Alerts</b> .....	<b>166</b>
Alarm Frequency Settings .....	167
<b>Codepage Mapping</b> .....	<b>168</b>
<b>Searching POS Data</b> .....	<b>169</b>
<b>POS Live View</b> .....	<b>170</b>
The POS Live View Window.....	170
Setting Up Live View.....	171
<b>POS Color Text</b> .....	<b>172</b>
Setting Up POS Color Text .....	172

## Point-Of-Sale (POS) Application

A POS system may be integrated to a GV-System through the GV-Data Capture box. Through the integration, you can investigate a transaction with transaction data overlaying on video footage, by either live viewing or playing back.

### POS System Connection

POS systems vary in different forms, with a receipt printer attached internally or externally (also called cash register), and with the text or graphic mode.

For the information on attaching the text-mode POS system to GV-System, visit the related links below.

To access	Visit
DB9 Interface POS System	<a href="http://www.geovision.com.tw/english/faq/POSflowchart/text/DB9_POS.pdf">http://www.geovision.com.tw/english/faq/POSflowchart/text/DB9_POS.pdf</a>
DB25 Interface POS System	<a href="http://www.geovision.com.tw/english/faq/POSflowchart/text/DB25_POS.pdf">http://www.geovision.com.tw/english/faq/POSflowchart/text/DB25_POS.pdf</a>
DB9 Interface Cash Register	<a href="http://www.geovision.com.tw/english/faq/POSflowchart/text/DB9_cash.pdf">http://www.geovision.com.tw/english/faq/POSflowchart/text/DB9_cash.pdf</a>
DB25 Interface Cash Register	<a href="http://www.geovision.com.tw/english/faq/POSflowchart/text/DB25_cash.pdf">http://www.geovision.com.tw/english/faq/POSflowchart/text/DB25_cash.pdf</a>

To attach the graphic-mode POS system to GV-System, first check if your POS system has these two characteristics:

- Windows operating system
- Serial port (COM port) for output

For the application of the graphic-mode POS system, you need:

- Additional USB dongle
- *POS Data Sender* program (included in the Software CD)

If you are not sure about the printing mode of your POS system, refer to *The Printing Mode of POS System/Cash Register* at this link:

[http://www.geovision.com.tw/english/faq/POSflowchart/The\\_printing\\_mode\\_of\\_POS\\_system\\_cash\\_register.pdf](http://www.geovision.com.tw/english/faq/POSflowchart/The_printing_mode_of_POS_system_cash_register.pdf)



## POS Data Sender

To attach the graphic-mode POS system with the Windows operation system and serial output to GV-System, follow these steps:

1. Connect the POS system as illustrated below.

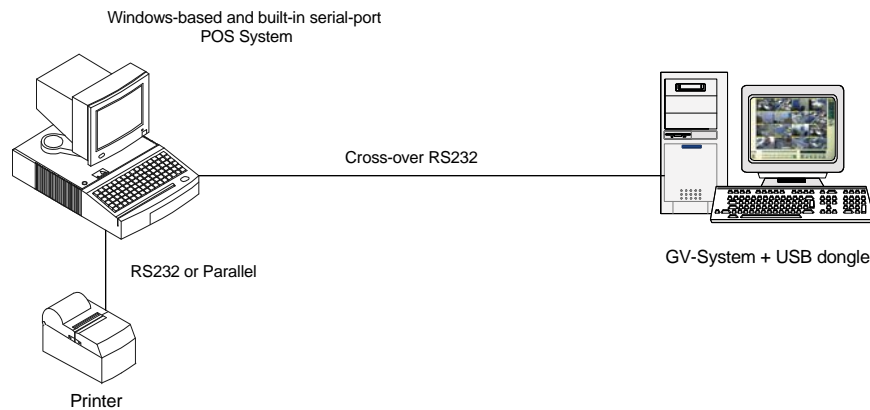

2. Insert the Surveillance System Software CD to the POS system. It will run automatically, and a window appears.
3. Select the **Install V 8.2.0.0 System**.
4. Select the **Software POS Driver (Only for Graphic mode POS System)**, and follow on-screen instructions to complete the installation.
5. Go to **Windows Start**, point to **Programs**, select **DVR-POS**, and then click **DVR POS Driver**. The following window appears.

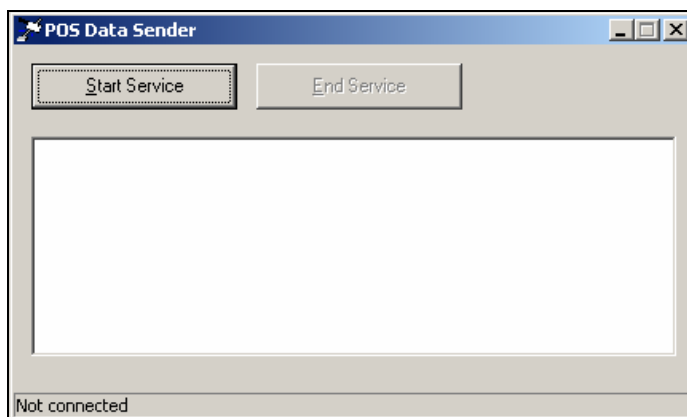

**Figure 3-1** POS Data Sender

6. Click **Start Service**, and then select the COM port to send graphic data to the GV-System.

---

**Note:** The GV-System must be configured and ready for this application. To set up the GV-System, see *Setting a POS System* below.

---

## Setting a POS System

To connect a POS system to GV-System, follow these steps:

1. On the main screen, click the **Configure** button, point to **Accessories**, click **POS Application Setting**, and then select **POS Device Setup**. The POS Sever Setup window appears.

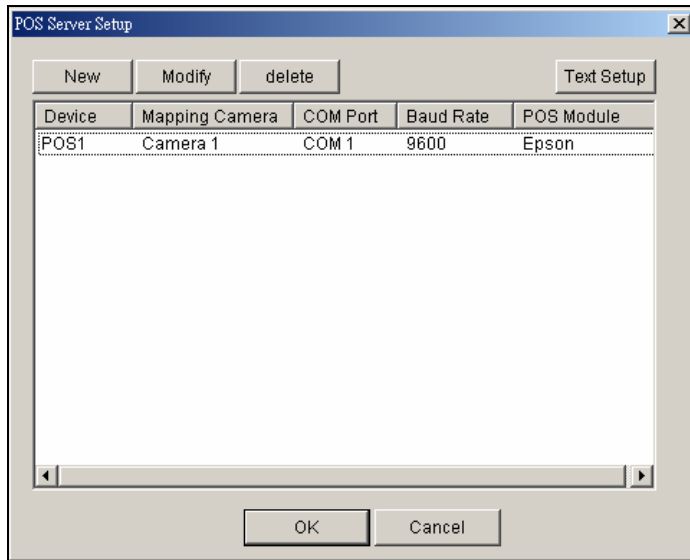

**Figure 3-2** POS Server Setup

2. Click the **New** button in the upper part of the window. The following dialog box appears.

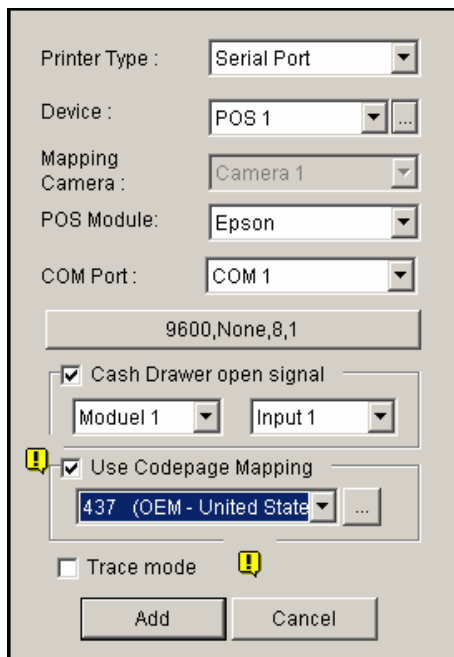

**Figure 3-3** POS system settings

- **Printer Type:** Select **Serial Port**, **Parallel Port** or **TCP/IP Port** that the POS system belongs to.  
For TCP/IP Port applications, see *GV-Data Capture V3 Series User's Manual*.
  - **Device:** Assign the POS system to a camera screen. POS 1 displays the images and data on the Camera 1 screen; POS 2 on the Camera 2 screen, and so on. Click the [...] button next to the item to rename the device.
  - **POS Module:** Select the printer attached to the POS system. If it's not Epson, select **General** for other brands. If the printing is in the graphic mode, select **GraphMode**.  
For Graphic mode applications, see the *POS System Connection* section above.
  - **COM Port:** Select the COM port that the POS system is connected to.
  - **The parameter button:** Click the button to configure Baud Rate, Data Bits, Parity, and/or Stop Bits to match those of the POS system, or keep them as defaults.
  - **Cash Drawer Open Signal:** This option is only available when an input module is configured in the Main System. Assign the input module connected to the cash drawer. Every time when the cash drawer is opened, a signal will be sent to the Main System and recorded in System Log for later retrieval.
  - **Use Codepage Mapping:** This feature is to support special characters and symbols display. For details, see *Codepage Mapping*.
  - **Trace Mode:** Check this item only after getting the recommendation from our technical support staff.
3. After above settings, click **Add** to add the POS system to the Main System.

## Superimposing POS Data onto Camera Screen

Follow these steps to set camera screens with POS text data:

1. Open the POS Device Setup window (Figure 3-2).
2. Click the **Text Setup** button to set text font and position of the data.

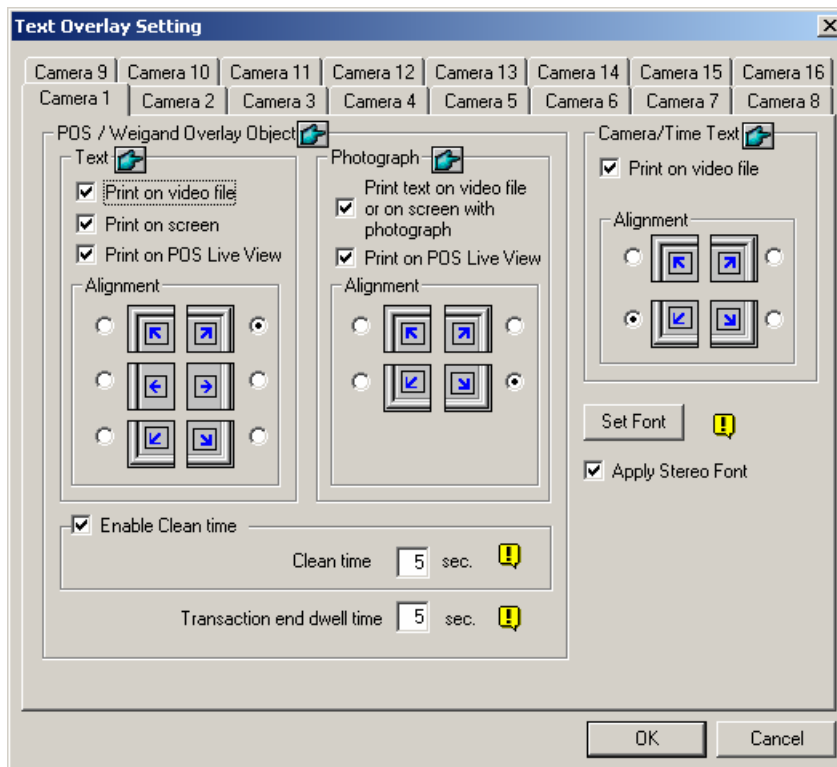

*Figure 3-4 Text Overlay Settings*

### [Text]

- **Print on video file:** Enable this option to display POS data on the recorded video file.
- **Print on screen:** Enable this option to display POS data on the transaction scene.
- **Print on POS Live View:** Enable this option to display POS data on the POS Live View window.
- **Alignment:** Select to set the position of text overlay on the screen.

### [Photograph]

- **Print text on video file or on screen with photograph:** Enable this option to overlay the photos with access text onto the live video or recorded file.
- **Print on POS Live View:** Enable this option to display the photos on the separate POS Live View window.
- **Alignment:** Select to set the position of photo overlay on the screen.

**[Enable clean time]** When the option is enabled, after the specified time in seconds that if GV-System hasn't received the transaction data from your POS system, the already-displayed data will disappear from the camera screen, i.e. the cashier stops entering the transaction data.

- **Transaction end dwell time:** Specify the amount of time in seconds that POS data stays on a view screen before the next transaction.

**[Camera/Time Text]**

- **Print on video file:** Enable this option to display camera ID and location name on the recorded video file.
- **Alignment:** Select how you want the camera information to be aligned on a view screen.

**[Set Font]** Click the **Set Font** button to set up the font for POS and Camera/Time text. The option **Apply Stereo Font** makes texts stand out from the background by giving white-edge to the texts.

## POS Field Filter

POS Field Filter allows you to create a column for a transaction item in System Log. It further filters the transaction conditions based on your criteria, and displays the results under the created column. To set up the function, follow these steps:

1. On the main screen, click the **Configure** button, point to **Accessories**, select **POS Application Setting**, and then select **POS Field Filter Setup**. This dialog box appears.

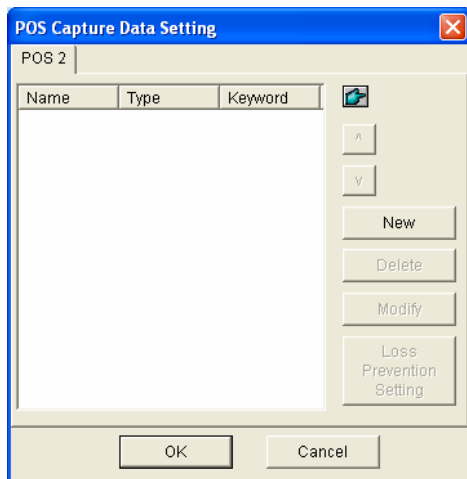

**Figure 3-5** POS Capture Data Setting

2. Click the **New** button and select **Caption Data**. This dialog box appears.

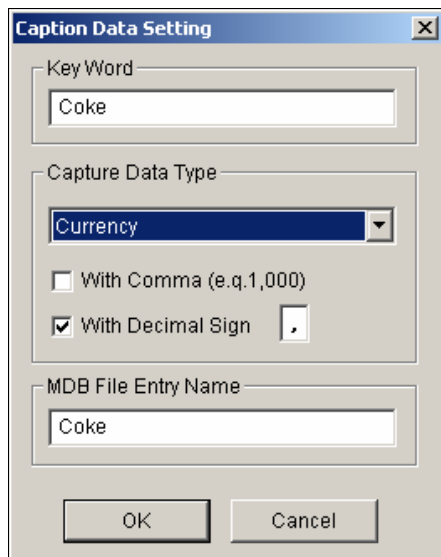

**Figure 3-6** Setting search criteria

**[Key Word]** Enter a meaningful keyword that matches exactly one of transaction items/texts in the receipt. The field is case sensitive. Suppose we enter Coke, and every text matching to Coke will be screened out.

**[Capture Data Type]** Select the type of data followed by the specified transaction item/text: **Numeric, Currency or Alphabetic**. If the specified transaction item/text is followed by a price amount, select **Numeric** or **Currency**. If it is followed by alphabets, select **Alphabetic**.

- **With Comma:** If there are commas in a price amount, check the option.
- **With Decimal Sign:** If there are decimal signs in a price amount, check the option.
- **With Space:** The option is only available when you select **Alphabetic**. If there is space among a series of characters, check the option.

**[MDB File Entry Name]** Enter a file name to store the data.

3. Click **OK** to apply the above settings.
4. Open System Log. In System Log, for this example, you can see the last column created for the transaction item Coke. The transactions matching the search criteria will be displayed under the created column.

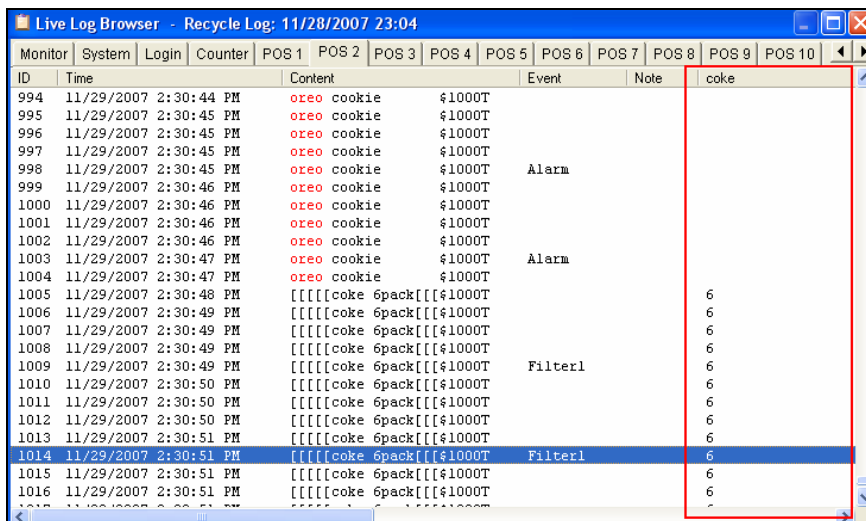
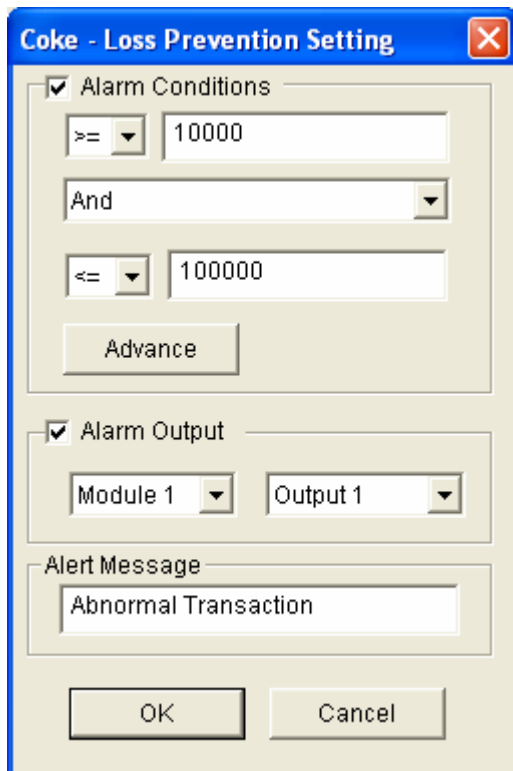

Figure 3-7 A created column in System Log

## Abnormal Transaction Alerts

When an abnormal transaction of the specified transaction item occurs, this function can automatically activate the output device and send out assigned E-Mail/SMS/Pager alerts. To set up this function, follow these steps:

1. Follow the instructions in *POS Filed Filter* earlier to set up a transaction item first.
2. In the POS Capture Data Setting dialog box (Figure 3-5), click the **Loss Prevention Setting** button. This dialog box appears.



**Figure 3-8** Loss Prevention Setting

**[Alarm Conditions]** Check this option and define the price range for an alarm condition. For this example, when the price amount in a transaction is *great than or equal to* ( $\geq$ ) 10000 and *less than or equal to* ( $\leq$ ) 100000, the assigned alarm will be activated.

**[Alarm Output]** Assign an installed output module for the application.

**[Alert Message]** Enter a desired alert message. To set up a notification type (E-Mail/Hotline/SMS), refer to *Send Alerts Approach* in Chapter 1.



## Alarm Frequency Settings

To eliminate false alarms and increase monitoring efficiency, you can set up alarm frequency conditions.

In the Loss Prevention Setting dialog box (Figure 3-8), click **Advance**. This dialog box appears.

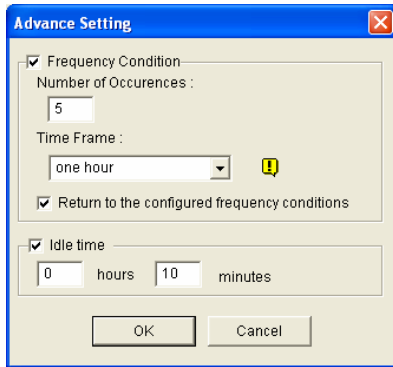

Figure 3-9

- **Frequency Condition:** Enable to set up the number of event occurrences within a given time period to trigger the alarm.
  - ⊙ **Number of Occurrences:** Specify the number of event occurrences.
  - ⊙ **Time Frame:** Select one of the time periods: **one hour, 12 hours, one day, one week or one month.**
  - ⊙ **Return to the configured frequency conditions:** After the alarm is triggered by the set frequency conditions, the system starts counting frequency again from zero. If this option was disabled and the frequency conditions have been met, the alarm will be triggered by every event.
- **Idle time:** To avoid constantly triggered alarms, you can set the time interval between each event occurrence.

In System Log, the events that match the alarm frequency settings are marked with “Alarm.”

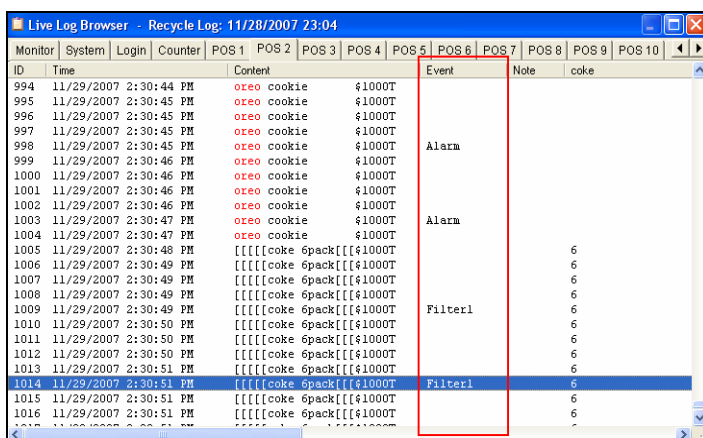

Figure 3-10

# Codepage Mapping

This feature is to support special characters and symbols display. When your transaction text appears on the screen incorrectly, your POS system may use different character code from GV-System's. To change a character code, follow these steps:

1. In Figure 3-3, enable **Use Codepage Mapping**, and then select a character code from the drop-down list.

---

**Note:** The codepage is related to “Script” in the **Set Font** option (Figure 3-4). When this option is disabled, it means there are no codepages matching your script setting.

---

2. To verify the character code you selected, click the [...] button to preview its codepage.

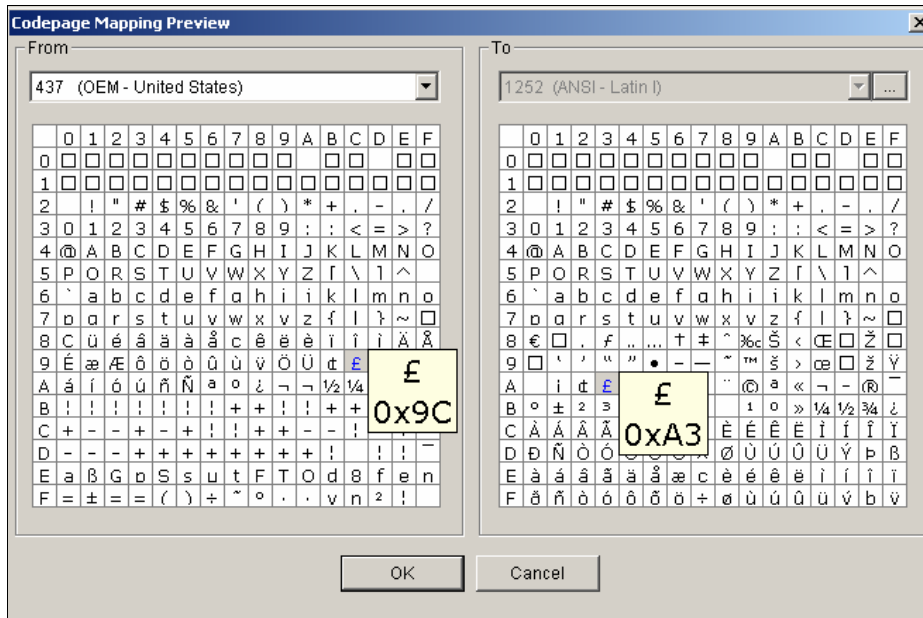

**Figure 3-11** Codepage Mapping Preview

3. In the From field, locate and click one of the symbols or characters that couldn't display correctly. For this example, you can see its previous character code (From side: 0x9C) has been transferred to the default equivalent (To side: 0xA3).

## Searching POS Data

You can locate any desired POS data and videos during a transaction. On the main screen, click the **ViewLog** button and then select **Search POS Data** to display the Quick Search window. When the Quick Search starts, the latest transaction video and data will always be displayed. For details on this feature, see *Quick Search* in Chapter 4.

---

**Note:** When POS data search is performed and IP cameras are in use with the POS system, please note the following:

1. In an Internet environment, POS data cannot match the images properly during the POS data search. Therefore, IP cameras are not recommended to be used on POS systems in this condition.
  2. In a LAN environment, there will be image delay between each POS data and images. The delay is about 3 frames before or after the matched data record.
-

## POS Live View

The POS Live View can display transaction data in a separate window instead of overlaying data on the main screen. It features:

- Fast access to transaction data without opening System Log.
- The View is designed for high screen resolution of 1280 x 1024. When your monitor supports 1280 x 1024 and the main screen is set to 1024 x 768, you can juxtapose the main screen and the POS Live View.

### The POS Live View Window

On the main screen, click the **ViewLog** button, and then select **POS Live View**.



**Figure 3-12**

The controls in the POS Live View Window:

No.	Name	Description
1	Previous Transaction	Goes to the previous transaction data.
2	Next Transaction	Goes to the next transaction data.
3	Freeze	Suspends the current transaction data display. Clicking this button again will restore to the live display.
4	Live View Menu	Accesses the settings of POS Live View.
5	Exit	Closes the POS Live View window.

## Setting Up Live View

To change the display status on the POS Live View window, click the **Live View Menu** button (No.4, Figure 3-10) and select **Live View Setup**. This dialog box appears.

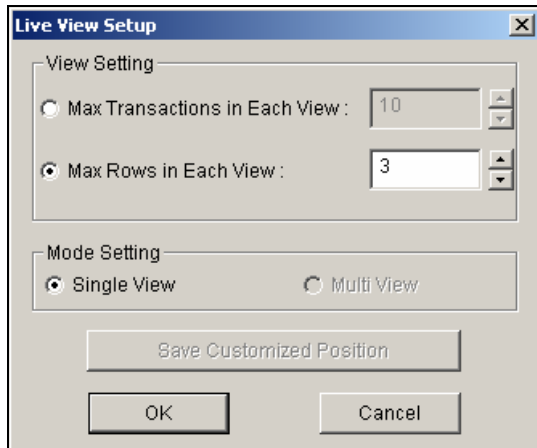

**Figure 3-13**

### [View Setting]

- **Max Transactions in Each View:** Enter the number of transactions you want to keep on the POS Live View window. For example, if you enter 99, there are always 99 transactions kept on the window. When the 100th transaction is entered, the oldest transaction data will be deleted to remain the max. transaction number to 99.
- **Max Rows in Each View:** Enter the number of transaction rows you want to keep on the POS Live View window, which includes any materials printed by POS System, e.g. data and time.

### [Mode Setting]

Select one single POS Live View window or multiple windows to display on the screen.

**Save User Define Arrange Position:** Allows you to freely place the multiple windows on the screen.

To use this feature:

- (1) Drag the windows to the desired places on the screen.
- (2) Open the Live View Setup dialog box, and click this option. When this warning message appears: *Are you sure to save User Define Arrange Position?*, click **Yes** to save your arrangement.

Whenever you want to place the POS Live View windows as your previous arrangement, click the **Live View Menu** button, point to **Arrange Views**, and select **Custom View**.

## POS Color Text

You can use different colors and time periods to identify any desired transaction items. When the transaction item is identified, the feature can trigger the alarm and send out the alert message. The identification is recorded in the System Log for later retrieval as well.

For example, if the liquor is prohibited from being sold in the midnight, a seller can use this feature to prevent from any unintentional sale.

### Setting Up POS Color Text

1. On the main screen, click the **Configure** button, point to **Accessories**, click **POS Application Setting**, and select **POS Filed Filter Setup**. The POS Capture Data Setting dialog box (Figure 3-5) appears.
2. Click **New** and select **Color Keyword**. This dialog box appears.

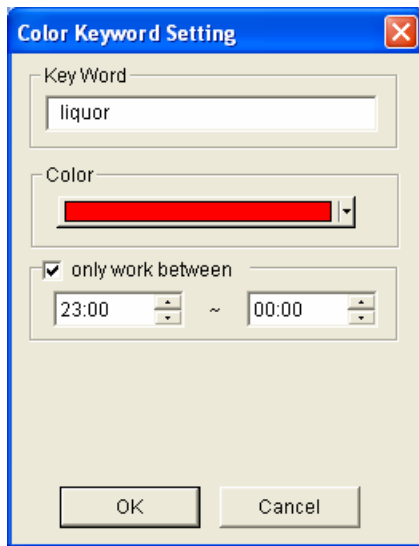

**Figure 3-14**

**[Key Word]** Type the text to be identified in the transaction data. The keyword setting is case sensitive.

**[Color]** Specify a color to identify the defined text.

**[only work between]** Specify the time period to identify the defined text in the transaction data.

- To trigger an alarm when the defined text is detected during the transaction, click the **Loss Prevention Setting** button in the POS Capture Data Setting dialog box (Figure 3-5). This dialog box appears.

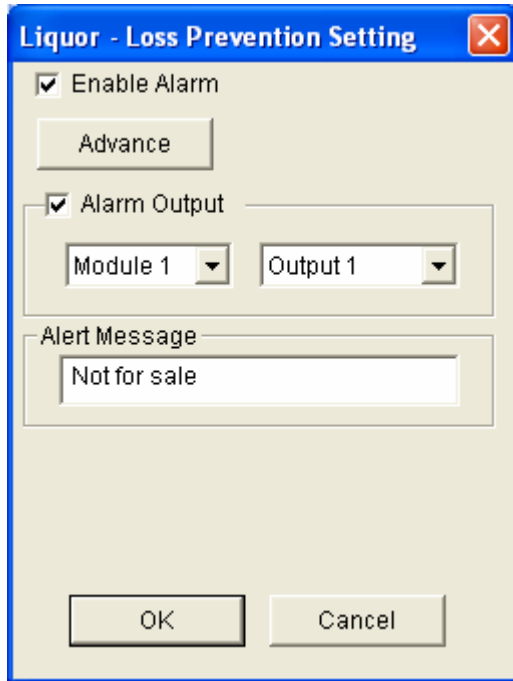

**Figure 3-15**

- **Enable Alarm:** Check this item to enable the alarm when the identified text is detected. To set up alarm frequency conditions, click the **Advance** button. For details see *Alarm Frequency Settings* earlier in this chapter.
  - **Alarm Output:** Check this item and use the drop-down lists to select the connected module and output device.
  - **Alert Message:** Type the message for the E-mail or SMS alerts to be sent out when the alarm is triggered.
- Click **OK** to save the above settings.

- When the defined text is identified in the transaction data, the identification appears not only on the main screen but also on the POS Live View window. It is also recorded in the System Log.

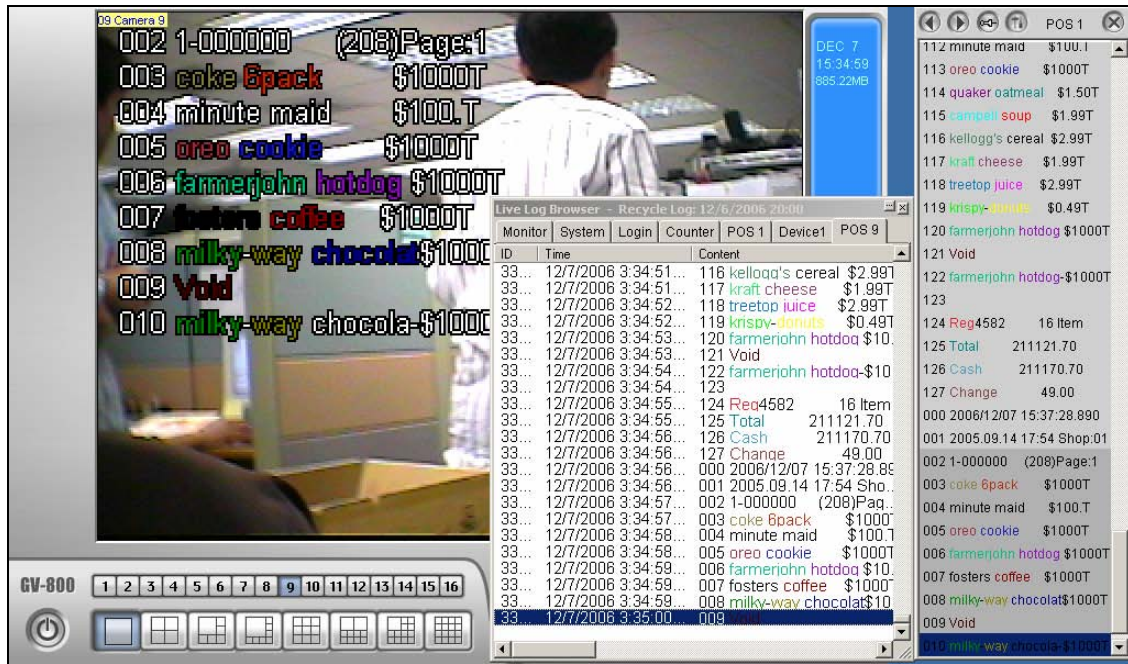

Figure 3-16

**Note:** You can set the maximum of 32 keywords for identification.



# Chapter 4

---

## Playing Back Video Files ..... 176

<b>Playing Back on ViewLog .....</b>	<b>176</b>
Playback Screen Layout.....	180
Playback Control Buttons .....	181
A to B Playback Mode .....	181
Searching a Video Event .....	182
Timeline Search.....	184
Exporting Video .....	185
Extracting Frames from a Video Clip.....	188
Saving Images.....	189
Printing Images.....	190
Object Search .....	191
Searching and Playing Back Motion, Alarm, and POS Event .....	193
Advanced Setup .....	200
<b>Recycling Option for Video Files .....</b>	<b>206</b>
Unmarking All Never-Recycling Flags .....	206
Reserving Never-Recycling Flags .....	206
<b>Playing Back over Local Area Network (LAN) .....</b>	<b>207</b>
<b>Playing Back over Internet Using Remote ViewLog Service.....</b>	<b>209</b>
Retrieving Recorded Video.....	209
Viewing Connection Status.....	210
Resuming Backup.....	211
<b>Accessing Recordings from Multiple Hosts .....</b>	<b>212</b>
<b>Playing Back over Internet Using Remote Playback.....</b>	<b>213</b>
Working with Remote Playback Server at the Server PC .....	213
Working with Remote Playback Client at the Client PC .....	215
<b>Touch Screen Support.....</b>	<b>222</b>
<b>Fast Key Reference.....</b>	<b>223</b>
<b>Specifications.....</b>	<b>223</b>

## Playing Back Video Files

Recorded files can be played back using five different software applications offered by the system – ViewLog, Quick Search, Remote Playback System, Remote Playback System WebCam version, and Q-View. Following is a comparison table for these applications. This is not a complete comparison table, because many of these features are dealt with in details throughout the manual. However, this table may help you to decide which application to use under a given situation.

Application	Description
ViewLog	Plays back video files on the servers and computers within the LAN, as well as supporting the Backup function.
Quick Search	A more convenient tool that allows you to search video files recorded on motion, alarm, or POS events.
Remote Playback System	Plays back files through network connection. Offers most complete playback features among the five. This application is a management system itself. It can download and play back history video files from several servers over Internet. See <i>Playing Back over Internet Using Remote Playback</i> , later in this chapter.
Remote Playback System WebCam version	No additional software installation is necessary. Just play back by your web browser. See <i>Remote Playback on WebCam</i> in Chapter 6.
Q-View	Plays back files saved at the remote site. It comes with the installation of any GV remote applications (Remote View and IP Multicast) for instant playback. This feature is discussed in Chapter 8.

This chapter discusses ViewLog, Quick Search, and Remote Playback System in details.

### Playing Back on ViewLog

The ViewLog would play back recorded video files without affecting recording. There are two ways to launch ViewLog:

- Start **Video Log** from the GV-folder (Windows Start menu/Programs)
- On the Main System, click the **ViewLog** button and then select **Video/Audio Log**. Or press **[F10]** on the keyboard.



**Figure 4-1** The ViewLog Window

By default when you open ViewLog, it will play the last event of camera number 1. Without further settings you could already play back the event by clicking the **Play** button on Playback Panel. Click the **View Mode** button (No. 6, Figure 4-1) to switch the current view mode to a multi-channel view. Use controls on Playback Panel to view the event in the way you want. Move the slider in Playback Meter (No. 11, Figure 4-1) forward and backward to navigate video frames.

To play back multiple events, keep pressing **[CTRL]** on the keyboard and highlight the desired events on the Video Event List (No. 4, Figure 4-1). Then click the **Play** button to play these events. To select events from different dates, click the date from the Date Tree (No. 3, Figure 4-1). Events of that date will be listed in the Video Event List.

---

**Note:** By default, the ViewLog is set to play back video “frame by frame without audio”. To change the playback method to real time with audio playback, please find the “Real Time or Frame by Frame” button (No.19, Figure 4-1) on the Playback Control Panel.

- **Frame by Frame (without audio):** Plays back video frame by frame. This method delays playback depending on bandwidth and computer performance, but all video frames are fully played back. When the view mode is set to be Panorama View, Quad View or MultiView, the default play mode is Frame by Frame.
  - **Real time:** Plays back video on real time. This method saves waiting time for rendering, but drop frames to give the appearance of real-time playback. When the view mode is set to be Single, the default play mode is Real Time.
-

The controls in the ViewLog window:

No.	Name	Description
1	Camera Name	Indicates the given camera name.
2	Camera View	Displays the playback video.
3	Date Tree	Displays date folders.
4	Video Event List	Displays video events within a certain date folder.
5	Arrow Switch	Switches between video event list and multiple host connection list.
6	View Mode	Sets screen divisions: Single View, Panorama View, Quad View or Multi View. Single View also includes these options: Standard, Thumbnail, Mega Pixel (PIP) and Mega Pixel (PAP).
7	Camera Select	Sets a desired camera for display.
8	Advanced	Accesses the basic, advanced search, timeline search and reloads video event list.
9	Normal	Displays the date tree, video event list and multiple host connection list.
10	Function Panel	Provides various settings for ViewLog.
11	Scroll Bar	Scrolls forward or backward of the playback video.
12	Audio Playback	Enables audio playback.
13	Playback Panel	Contains typical playback control buttons.
14	Function Icons	A highlighted icon indicates an enabled function. From left to right are the A to B Mode, auto playing of next events, the contrast and brightness function, the light enhancement and equalization function, the sharpness and smoothness function, the grayscale function, reconnection to Remote ViewLog, the defogging function and stabilizer function.
15	Playback Speed	Indicates the playback speed. x1 represents normal playback speed.
16	Time Display	Indicates the time of the playback video.
17	Date Display	Indicates the date of the playback video.
18	Exit	Closes or minimizes the ViewLog window.
19	A to B Mode	Plays repeatedly the set frames A to B.
20	Frame by Frame / Real Time	Plays back video frame by frame or on real time.

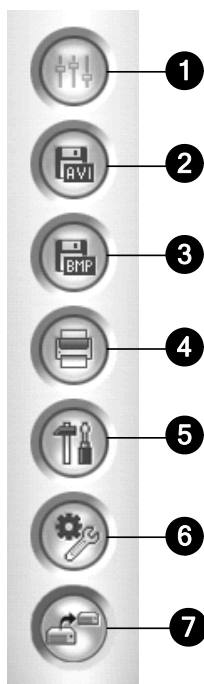

**Figure 4-2** Function Panel

The controls in the Function Panel:

No.	Name	Description
1	Effects	Adds effects to the images. The effect options include: Sample, Contrast/Brightness, Light Enhancement, Equalization, Sharpen, Smooth, Defog, Stabilizer, Grayscale, Copy, Undo to Prev. Action and Undo All Effects.
2	Save As AVI	Save a video file as avi or exe format. See <i>Exporting Video</i> later in this chapter.
3	Save As Image	Save a video image as bmp, jpg, gif, png, or tif format. See <i>Saving Images</i> later in this chapter.
4	Print	Specifies various settings for printing.
5	Setting	Accesses system settings of ViewLog. See <i>Advanced Setup</i> later in this chapter.
6	Tools	Brings up these options: Object Search, Advanced Log Browser, Delete, Remote ViewLog Service, Address Book, Full Screen and Tool Kit. See <i>Object Search</i> , <i>Searching and Playing Back Motion</i> , <i>Alarm and POS Event</i> , <i>Playing Back Over Internet Using Remote ViewLog Service</i> later in this chapter.
7	Backup	Backs up video files. See <i>Backing Up and Deleting Files</i> in Chapter 5.

## Playback Screen Layout

Click the **View Mode** button to select the following screen layouts:

- **Single View:** Includes four types of layout:
  - Standard:** Displays one playback channel only.
  - Thumbnail:** Reviews images frame by frame in thumbnails. Only one camera at a time can be selected for this function.
  - Mega Pixel (PIP):** Crops a video to get a close-up view or zoom in on the video. For details, see *Picture-in-Picture View* in Chapter 1.
  - Mega Pixel (PAP):** Creates a split video effect with multiple close-up views on the image. For details, see *Picture-and-Picture View* in Chapter 1.
- **Panorama View:** Plays back in continuous scenes. For details, see *Panorama View* in Chapter 1. Note this function is only available when an appropriate USB dongle is used.
- **Quad View:** Plays back in a quad layout.
- **Multi View:** Plays back all available cameras.

Click the **View Mode** button (No. 6, Figure 4-1) any time when you want to change the current view mode. The option of Thumbnail View is disabled while a video file is playing back. Wait until the video ends or click the **Pause** button to make the option available.

In a thumbnail view, a video file is divided into a set of frames. The frames are displayed in 25 playback windows, shown as follows. The key frame is in the center, with 12 video frames occurred before and after the key frame. This helps to locate required frames you may otherwise miss by other viewing methods.



**Figure 4-3**

## Playback Control Buttons

Video files may be played back with or without audio. To play back with audio, click the **Audio Playback** button, as shown below. (Please note not all GV cards support the audio function.)

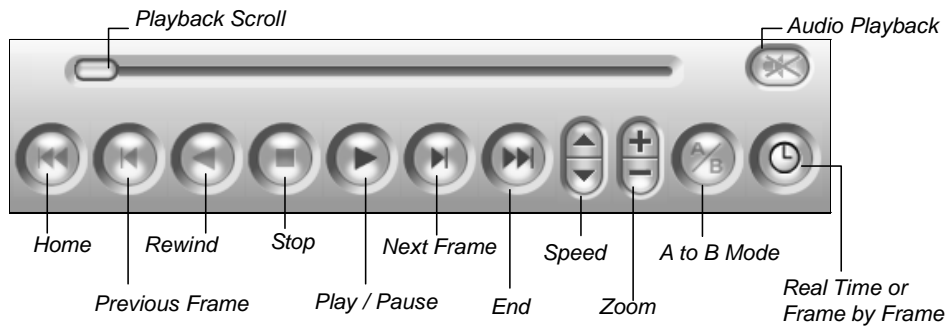

**Figure 4-4**

## A to B Playback Mode

When playing video events, you can set a starting and an ending frame for auto-playing:

1. To set the starting frame A, click the **A to B Mode** button (Figure 4-4). The message *A to B Mode (Set A)* appears on the screen.
2. To set the ending frame B, click the **A to B Mode** button. The message *A to B Mode (Set B)* appears on the screen.

ViewLog will start playing the set frames A to B repeatedly. To stop the playing, click the **A to B Mode** button; the message *A to B Mode (Cancelled)* will appear.

## Searching a Video Event

ViewLog offers two search methods: the Basic and the Advanced, allowing you to locate a video event within a certain date, time or camera.

### Basic Search

1. Click the **Advanced** button (No. 8, Figure 4-1) and select **Basic Search** to display the following dialog box. Alternatively, press **[CTRL] + [F8]** on the keyboard to call it up.

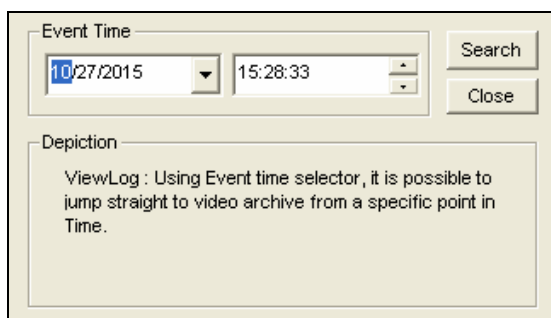

**Figure 4-5**

2. Specify a desired date and time.
3. Click the **Search** button for the search. If the specified time can't be found, a prompt will appear for you to select a next or previous video event available.



## Advanced Search

1. Click the **Advanced** button (No. 8, Figure 4-1) and select **Advanced Search** to call up the following dialog box. Alternatively, press **[F8]** on the keyboard to call it up.

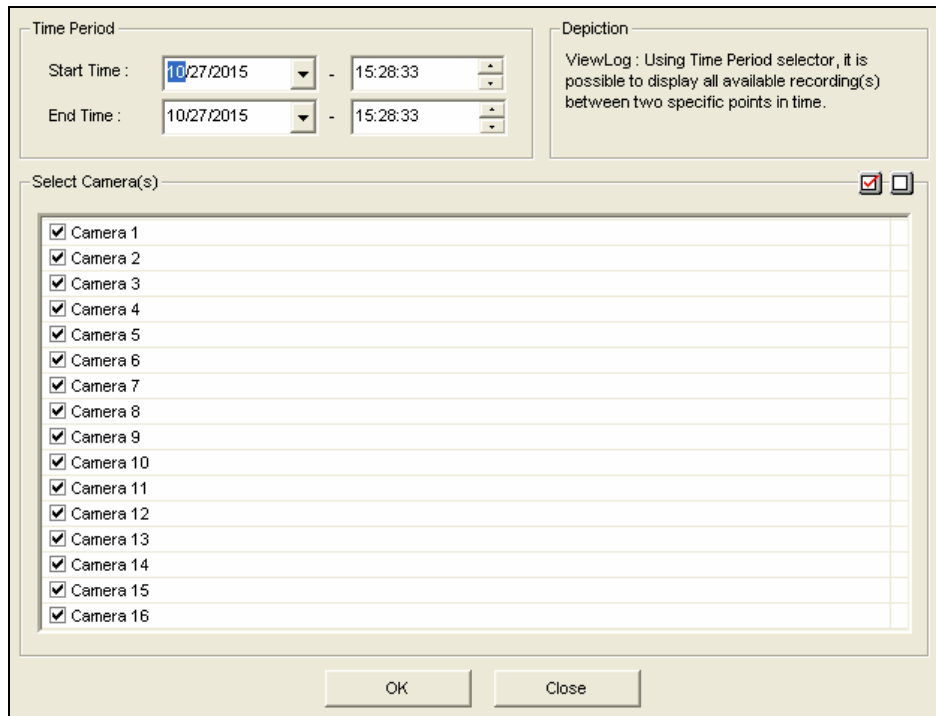

The dialog box is titled "Advanced Search" and is divided into several sections. At the top left, under "Time Period", there are two rows of time selection. The first row is for "Start Time" with a date dropdown set to "10/27/2015" and a time dropdown set to "15:28:33". The second row is for "End Time" with a date dropdown set to "10/27/2015" and a time dropdown set to "15:28:33". To the right of this section is a "Depiction" area containing the text: "ViewLog : Using Time Period selector, it is possible to display all available recording(s) between two specific points in time." Below the time period section is a "Select Camera(s)" section with a list of 16 cameras, each with a checked checkbox. At the bottom of the dialog are "OK" and "Close" buttons.

Camera	Selected
Camera 1	<input checked="" type="checkbox"/>
Camera 2	<input checked="" type="checkbox"/>
Camera 3	<input checked="" type="checkbox"/>
Camera 4	<input checked="" type="checkbox"/>
Camera 5	<input checked="" type="checkbox"/>
Camera 6	<input checked="" type="checkbox"/>
Camera 7	<input checked="" type="checkbox"/>
Camera 8	<input checked="" type="checkbox"/>
Camera 9	<input checked="" type="checkbox"/>
Camera 10	<input checked="" type="checkbox"/>
Camera 11	<input checked="" type="checkbox"/>
Camera 12	<input checked="" type="checkbox"/>
Camera 13	<input checked="" type="checkbox"/>
Camera 14	<input checked="" type="checkbox"/>
Camera 15	<input checked="" type="checkbox"/>
Camera 16	<input checked="" type="checkbox"/>

**Figure 4-6**

2. Specify the desired date, time period, and cameras for search.
3. Click **OK** to start searching.
4. In the Video Event list, the events matching the search criteria will be highlighted in gray color. Click the **Play** button to play back the highlighted events.

## Timeline Search

In addition to Date Tree, the system provides you another graphical search method called “Timeline” to locate the desired video events within a set period of time.

1. Select the desired view mode for playback by clicking the **View Mode** button. If you select **Single View**, assign a camera from the Camera drop-down list.
2. Click the **Advanced** button (No.8, Figure 4-1), and select **Timeline Search**. This window appears.

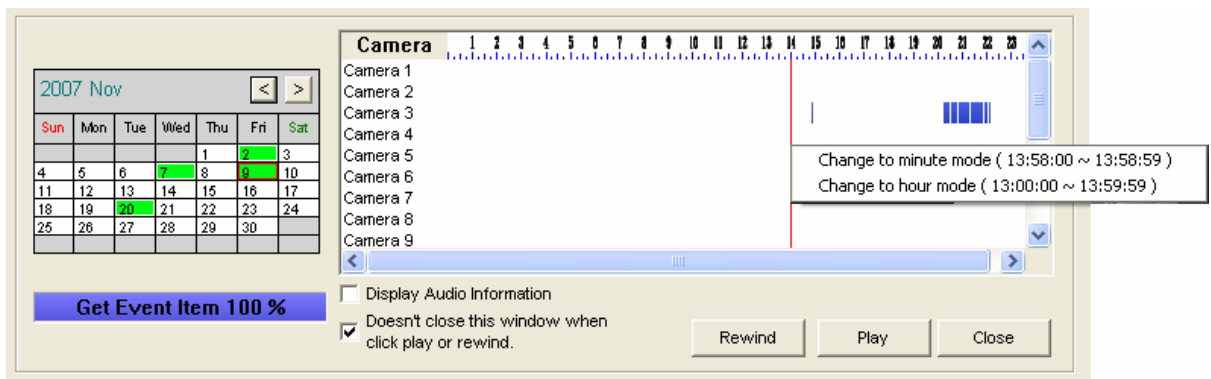

**Figure 4-7**

3. Select a date from the calendar.
  - The date with recorded events is displayed in GREEN color.
  - On the right panel, the BLUE blocks indicate which camera has recorded events on the selected date and at which hour.
4. Move the mouse pointer on the desired BLUE block, and right-click it to have the sub Timelines of hour mode and minute mode. Three types of timeline modes are available:
  - **Change to day mode:** The default mode displaying at which hour the events have been recorded.
  - **Change to hour mode:** Opens the sub Timeline displaying at which minute the events have been recorded.
  - **Change to minute mode:** Opens the sub Timeline displaying at which second the events have been recorded.
5. Click on the BLUE block of the desired time, and then click **Play** or **Rewind** for playback. If you do not want to close the Timeline Search window during playback or rewinding, select the **Doesn't close this Window when click play or rewind** option.

## Exporting Video

You can export a certain time period within a video event and play it back at the place where ViewLog is not available. The maximum length of the exported file is 1 hour.

1. Locate a desired file from the date tree and video event list (No. 3 & 4, Figure 4-1).
2. Select the screen division from the View Mode button (No. 6, Figure 4-1).
3. Click the **Save As AVI** button (No. 2, Figure 4-2). This window appears.

Alternatively, press **[S]** on the keyboard to call it up.

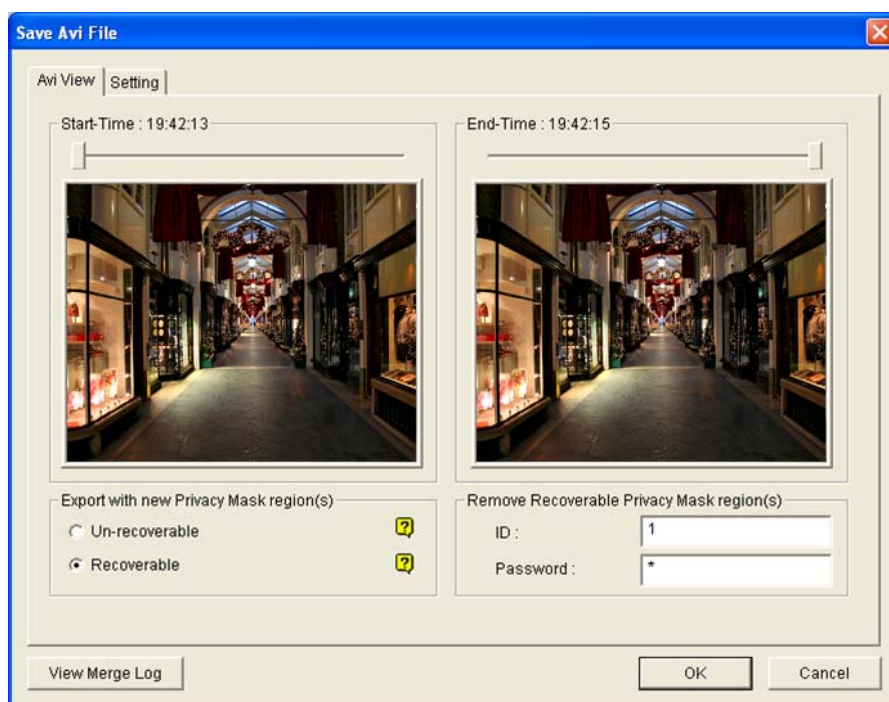

**Figure 4-8** Save AVI File

5. Drag the timelines to define a starting and ending time of the file.
6. If the video event has the Privacy Mask settings, and you want to retrieve the recoverable block-out area(s) in the exported file, type a valid ID and password in the Remove Recoverable Privacy Mask region(s) field. If you want to remain the recoverable block-out area(s) in the exported file, leave the field blank.
7. If you want to add more Privacy Masks onto the video, follow the instructions in *Privacy Mask Settings* below.
8. To configure the saving path and format of the exported video, click the **Setting** tab. For details see *AVI File Settings* below.
9. Click **OK** to export and save the file.

## Privacy Mask Settings

In case you forget to set the Privacy Mask at the Main System or need to add more Privacy Masks onto the video for special requirements, you can do that in ViewLog.

1. In the Export with New Privacy Mask Region(s) section (Figure 4-8), select **Un-recoverable** and/or **Recoverable**.
  - **Un-recoverable:** The block-out area(s) in the recorded clips cannot be retrieved.
  - **Recoverable:** The block-out area(s) is retrievable with password protection.
2. Drag the area(s) where you want to block out on the image. You will be prompted to click **Add** to save the setting.

Using a valid ID and Password, you can retrieve the recoverable block-out area(s) in the exported file. For details on the Privacy Mask, see *Privacy Mask Protection* in Chapter 1.

## AVI File Settings

To configure the format of exported video, follow these steps:

1. Click the **Setting** tab on the Save AVI File window. This window appears.  
Note that when you save the AVI file in single view mode, the window looks slightly different.

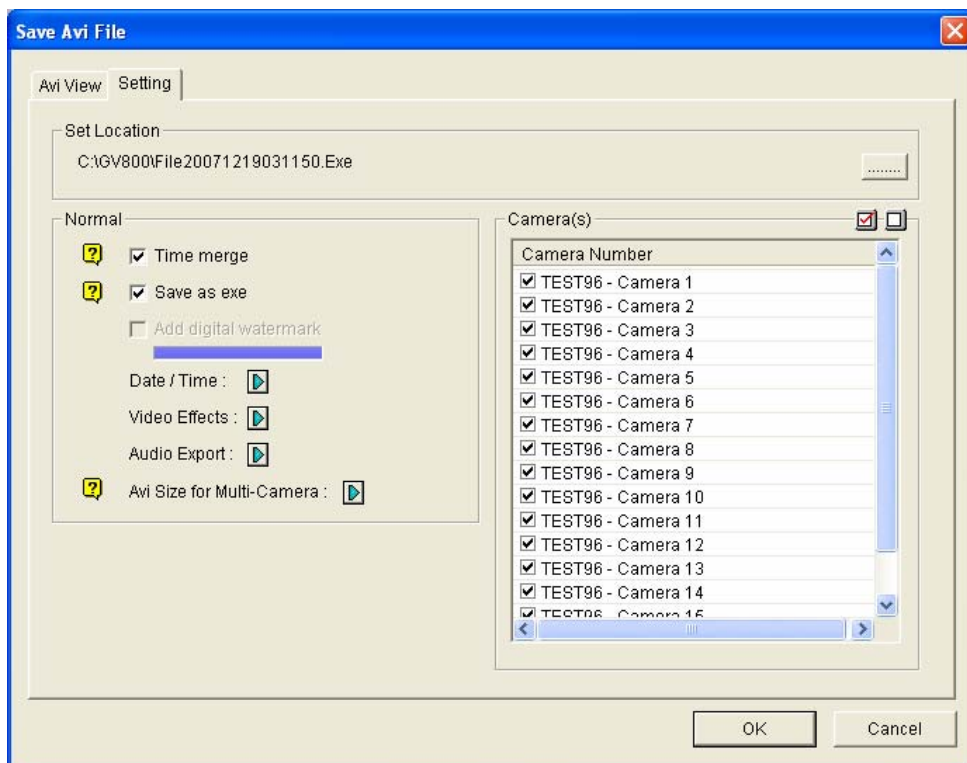

**Figure 4-9**

**[Set Location]** Click the [...] button to assign a saving path.

**[Normal]**

- **Time Merge:** Select whether to save a full-length video with recorded and non-recorded periods. The non-recorded period will display a blank blue screen. This option is designed to accurately reflect your recording status.
- **Save as EXE:** Select whether to save files in EXE format. Enable this feature if you want to play back video at the computer without installing GV-System. This format allows you to auto-play the files with any third-party player.
- **Add digital watermark:** Select whether to include the watermark in the exported video. This option is only available when the watermark has been applied on the recorded video.
- **Date/Time:** Select whether to include date and/or time stamps. You can also select the stamp color.
- **Video Effects:** Select whether to include the special effects in the exported video. To include the effects of Defog, Stabilizer, Overlay's Camera and Time and Overlay's POS, you must have applied these functions on the recorded video.
- **Audio Export:** Select **Denoise** to remove audio noises from the video, or select **Channel** for audio exporting.
- **AVI Size for Multi Camera:** Select the screen size of the saved file.

**[Camera(s)]** Select which camera file for exporting.

2. Click **OK** to apply above settings.



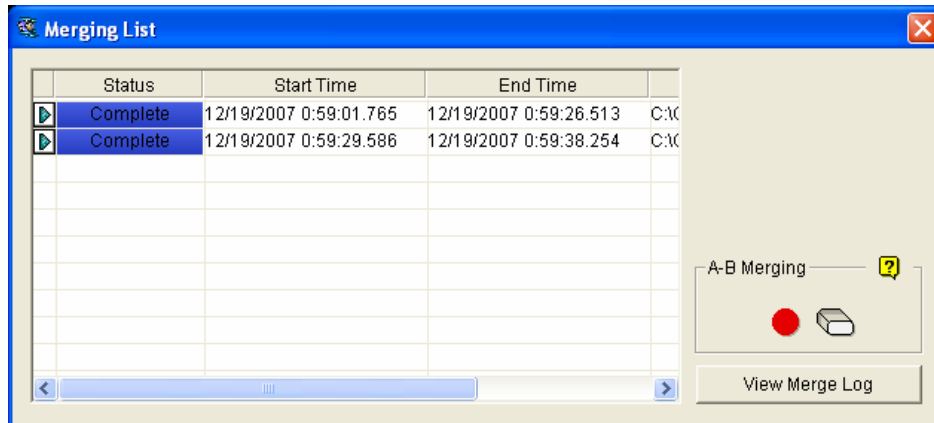

## Extracting Frames from a Video Clip

You can extract certain frames of a video clip and save them as another clip.

1. Click the **Save As Avi** button, and select **Display Merging List**. This dialog box appears.



**Figure 4-10**

2. Select a desired video file from the Video Event list.
3. Click the **Play** button on the Playback Panel to play the video.
4. To set the start frame, click the **A to B Mode** button  in the Merging List dialog box. The button turns black. If you want to reset the start frame, click the **Cancel** button  and then click the **A to B Mode** button  again to set a new start frame.
5. To set the end frame, click the **A to B Mode** button . The system starts extracting the specified frames from the file. When the extract is complete, the Status field displays “Complete”.
6. To view the video clip, click the arrow button beside the desired file, and select **Open**.

---

**Note:** If you want to clear the entries on the Merging List, click the arrow button beside the desired entry, and select **Clear**. The entry will be deleted, but the saved clip is still kept in the storage location.

---

## Saving Images

You can save the current camera view as an image file.

1. Click the **Save As Image** button (No. 2, Figure 4-2). This dialog box appears.

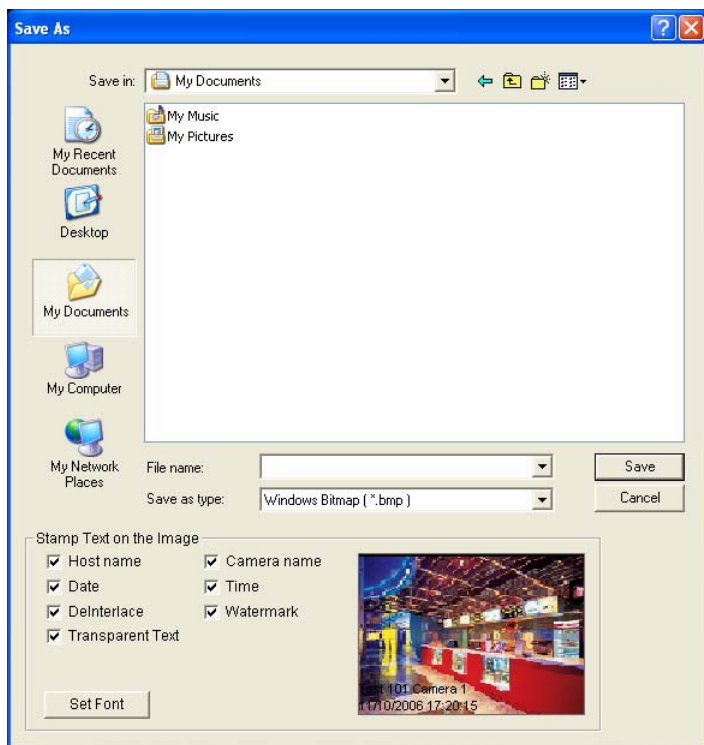

**Figure 4-11**

### [Stamp Text on the Image]

Select whether to include host name, camera name, date and/or time stamp on the image.

Selecting **Transparent Text** will create the stamp on the transparent background.

Selecting **Watermark** and **Deinterlace** will include the two features in the saved image.

Click the **Set Font** tab to set the font for the stamp.

**[The image]** Click on the image at the bottom to preview the stamp text. Click on the image again to close the preview window.

2. Name the file, select a file format, and then assign the location to save the image file.

## Printing Images

You can print images in three layout styles: single view, quad view or multi view.

1. Click the **View Mode** button (No. 6, Figure 4-1) to decide the screen layout.  
Note that Thumbnail View is not available for print.
2. Select an event in the Video Events list (No. 4, Figure 4-1), and then click the **Print** button. This dialog box appears.

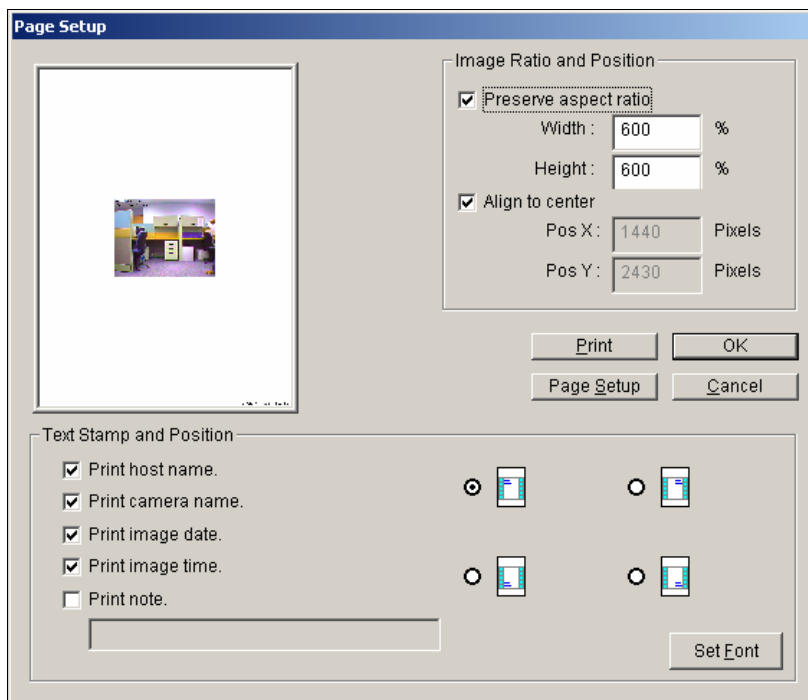

**Figure 4-12**

**[Image Ratio and Position]** Changes the size of the image and its position on the page. This option is only available in Single View mode.

- **Preserve aspect ratio:** Click to maintain the aspect ratio when resizing an image.
- **Align to center:** Click to change the position of the image on the page.

### **[Text Stamp and Position]**

Select whether to include the host name, camera name, date and/or time stamp on the printed image.

Select **Print note** to include a note below the image. Under the Print note field, type the text of less than 64 characters.

- **Stamp position icons:** Sets the position where the stamp is printed.
- **Set Font tab:** Click to select the font type for the stamp.

3. Click **OK** to save the settings or **Print** to print out the page.



## Object Search

This feature allows you to perform two functions: 1. Detect motion, missing objects or unattended objects within a certain region of a recorded file. 2. Perform the counting function within certain regions in a recorded file. The following gives an example of motion detection. For details on missing objects, unattended objects and counting, refer to *Configuring Object Counting* and *Detecting Unattended and Missing Objects* in Chapter 1.

1. Select a desired video file from the Video Event list for the search. Or select multiple files by clicking on each file while keeping pressing **[CTRL]** on the keyboard.
2. Click the **Tools** button (No.6, Figure 4-2) on the function panel, and then select **Object Search** to display the following window.

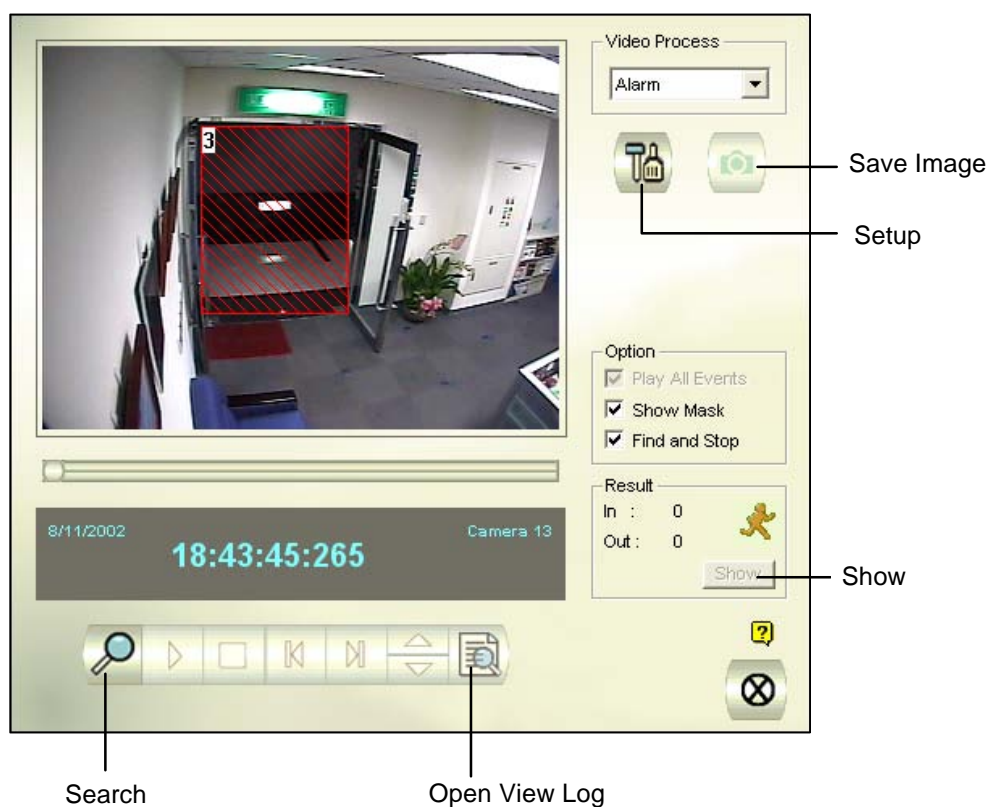

**Figure 4-13** Object Search

3. In the Video Process drop-down list, select **Alarm**.

- Click the **Setup** button for further settings. The following window will appear.

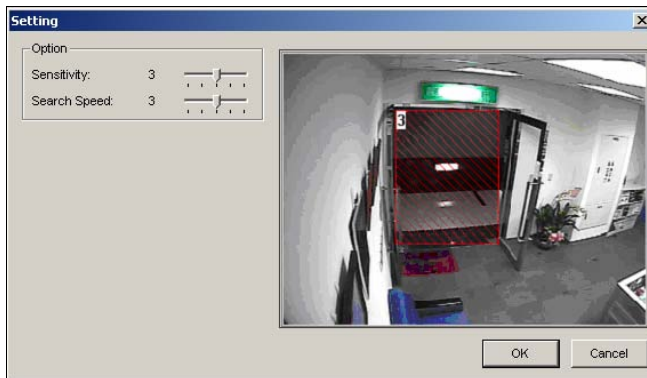

**Figure 4-14**

- Use the mouse to outline a region for motion detection. You will be prompted to enter **Alarm Region**.
- Keep detection Sensitivity and Search Speed as defaults or adjust them if needed.
- Click **OK** to finish the settings and close the window.
- In the Option section, you have several options:
  - **Play All Events:** Plays back the video segments found as a continuous series of images.
  - **Show Mask:** Shows masks on the detection regions.
  - **Find and Stop:** (recommended) Pauses the search process when motion is detected.
- In the control panel, click the **Search** button for the search.
- When any video segment matches the search criteria of motion detection, the **Show** button will be available. Click **Show** to display the Event List window.

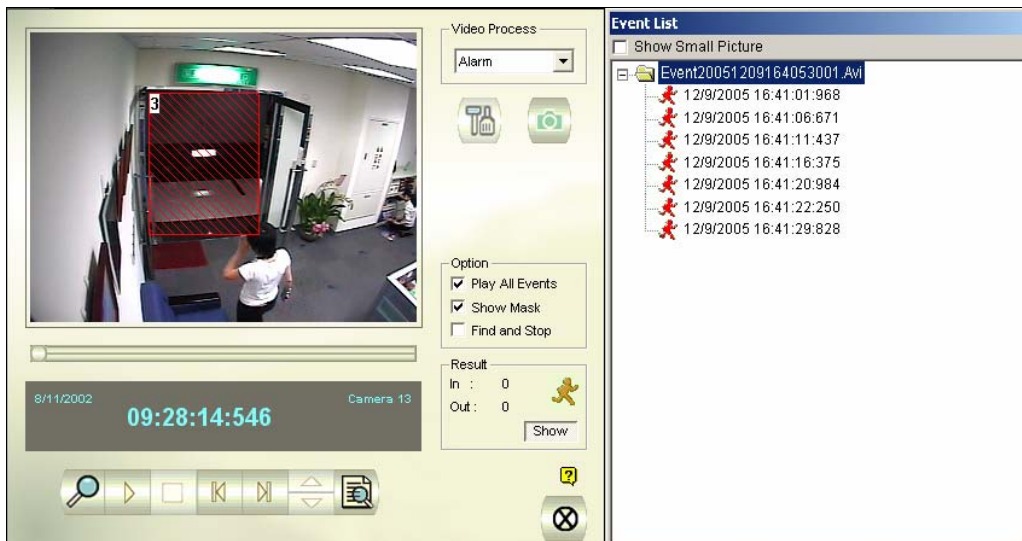

**Figure 4-15**

- Expand the event folders to see the video segments inside. Or, enable **Show Small Pictures** at the upper of window to access the thumbnail view.
- Select one video segment, and then click the **Play** button in the Object Search window to play it back. Or, click the **Open ViewLog** button to play it with ViewLog.

## Searching and Playing Back Motion, Alarm, and POS Event

1. Click the **Tools** button and select **Advanced Log Browser**. This dialog box appears.

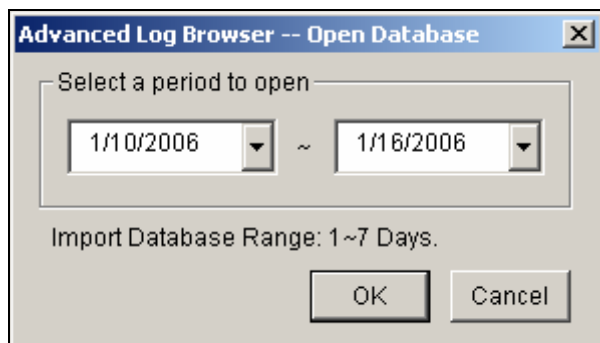

Figure 4-16

2. Specify a time range and click the **OK** button. All events within the specified range will be displayed on this Advanced Log Browser window.

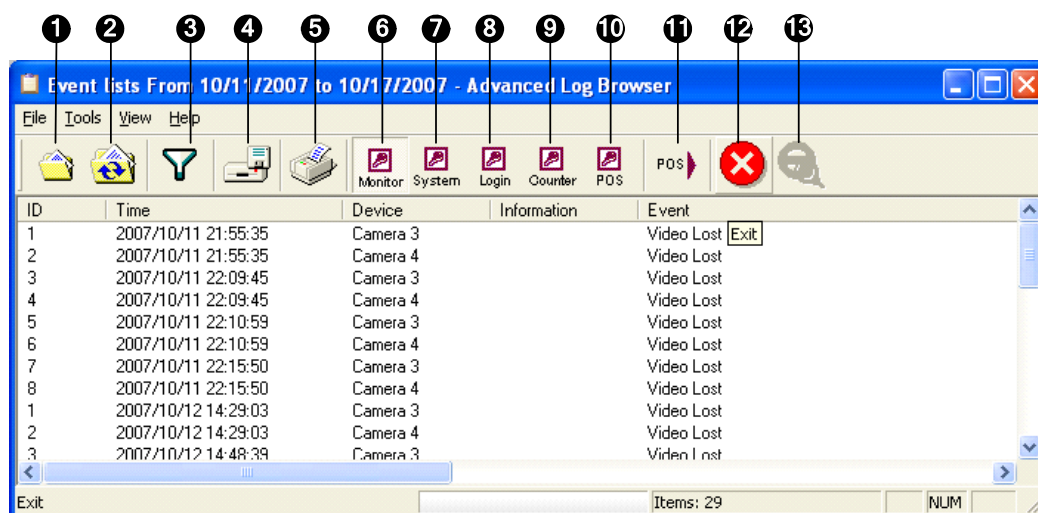

Figure 4-17 Advanced Log Browser

The buttons on the Advanced Log Browser:

No.	Name	Description
1	Open	Opens an event log.
2	Reload	Select <b>Reload All Table</b> or <b>Reload Current Table</b> to refresh loaded data.
3	Filter	Defines the search criteria.
4	Backup	Select <b>All Tables</b> to back up all log data, or selects <b>Current Table</b> to back up the current log table you are at.
5	Print	Prints the current log table.
6	Monitor Table	Displays the monitor log.
7	System Table	Displays the system log.
8	Login Table	Displays user's login/logout log.
9	Counter Table	Displays the counter log.
10	POS Table	Displays the POS log.
11	POS List	Accesses one POS channel for log data.
12	Exit	Exits the browser.
13	Filtering / Cancel Filtering	Appears to indicate the filtering process is being performed. You can click it to cancel the filtering. After the filtering is complete, this icon appears dimmed.

### Quick Search

Quick Search is a very useful tool for searching and playing back video files that are based on motion detection, alarm, or POS events. In the Advanced Log Browser Window, double-clicking the motion, alarm or POS event in Monitor table and POS table. The Quick Search window will appear. The following figure and table give you an overview on Quick Search's features and functional buttons.

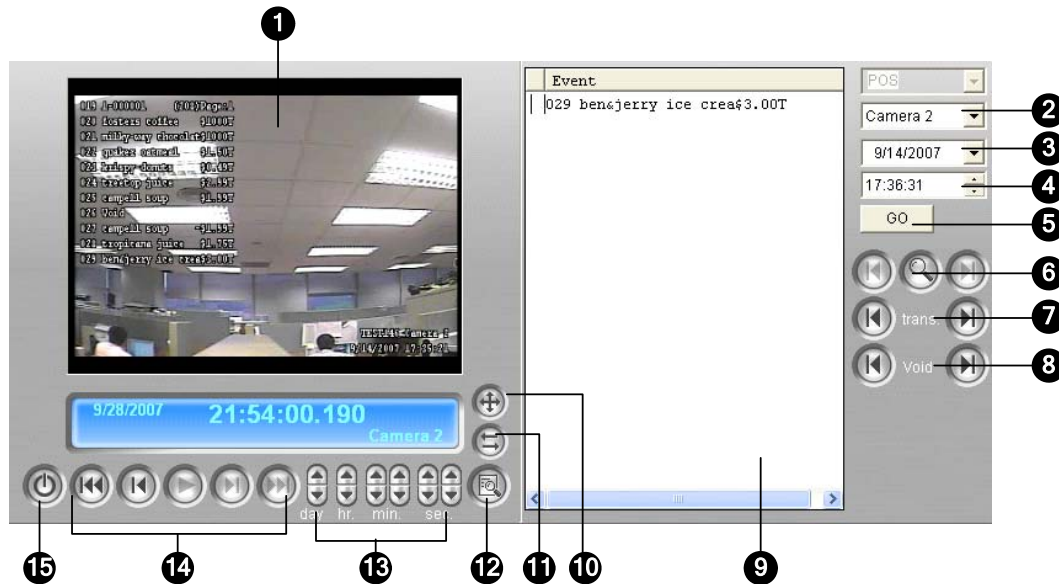
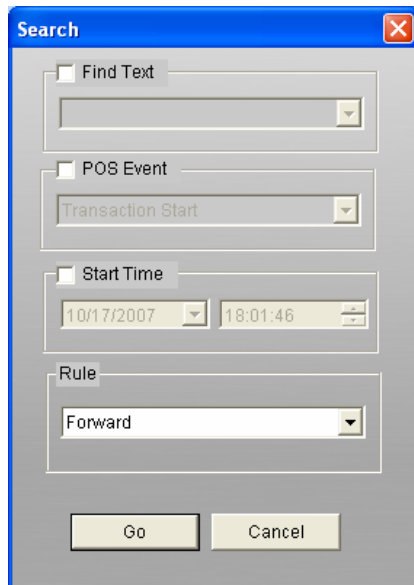

Figure 4-18 Quick Search

The controls on the Quick Search window:

No.	Name	Description
1	Monitoring Window	Displays video associated to the event
2	Camera Select	Use the drop-down list to select camera
3	Day Select	Use the drop-down list to select date
4	Time Select	Use the drop-down list to select time
5	Go Button	Click to search files that match to the parameters set above.
6	Event Query	Click to specify event query
7	Transaction	Use the arrow buttons to select previous or next transaction event.
8	Void	Use the arrow buttons to select previous or next void event.
9	Transaction Window	Displays POS transaction
10	320<->640	Click to switch between 640 x 480 and 320 x 240 display.
11	Expand / Shrink Dialog	Select <b>Expand/Shrink Dialog</b> to display the Transaction window or select <b>Advanced Search</b> to display the Advanced Search panel.
12	View by ViewLog	Click to open ViewLog player.
13	Time Period	Use these buttons to search event within the specified time.
14	Playback Panel	Includes Play, Pause, Previous 10 frames, Home, Next 10 frames, End buttons.
15	Exit	Click to close Quick Search screen

Click the **Event Query** button (No. 6, Figure 4-17) on the Quick Search window, and the following dialog box will appear. Use this function to find POS events by a specific item, transaction, or date.



**Figure 4-19**

**[Find Text]** Enable this option to find video events that match to the key word.

**[POS Event]** Enable this option to find video events that match to the specified transaction type.

**[Start Time]** Enable this function and use the drop-down list to specify date and time

**[Rule]** Specify to search forward or backward from the set date.

## Advanced Search Setting

To decide the size of Quick Search monitoring window and set up a list of favorite texts for search, follow these steps:

1. Click the **Expand/Shrink Dialog** button (No11, Figure 4-17), and select **Advanced Search**. The Advanced Search panel appears.
2. Click the **Setting** button  on the right side of the panel. This dialog box appears.

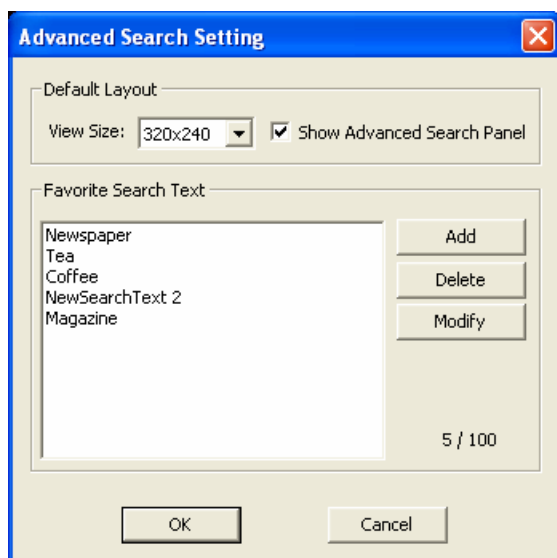

*Figure 4-20*

### [Default Layout]

- **View Size:** Selects 320 x 240 or 640 x 480 for the monitoring window size when the Quick Search is opened.
- **Show Advanced Search Panel:** Displays the Advanced Search panel when the Quick Search is opened.

### [Favorite Search Text]

Click the **Add** button to create a list of favorite texts for search. When you use the **Find Text** drop-down menu on the panel, this list is available for use. Up to 100 kinds of texts can be added to the list.

## Importing / Exporting Filter Configurations

You can import and export the Filter configurations in the Advanced Log Browser.

1. Click the **Advanced Log Browser** button  on the upper left corner, and select **Advanced Log Browser** to open the database.
2. On the toolbar, select the desired type of log table (Monitor, System, Login, Counter, POS), select **Default Filter**, and then click the **Filter** button. This dialog box appears.

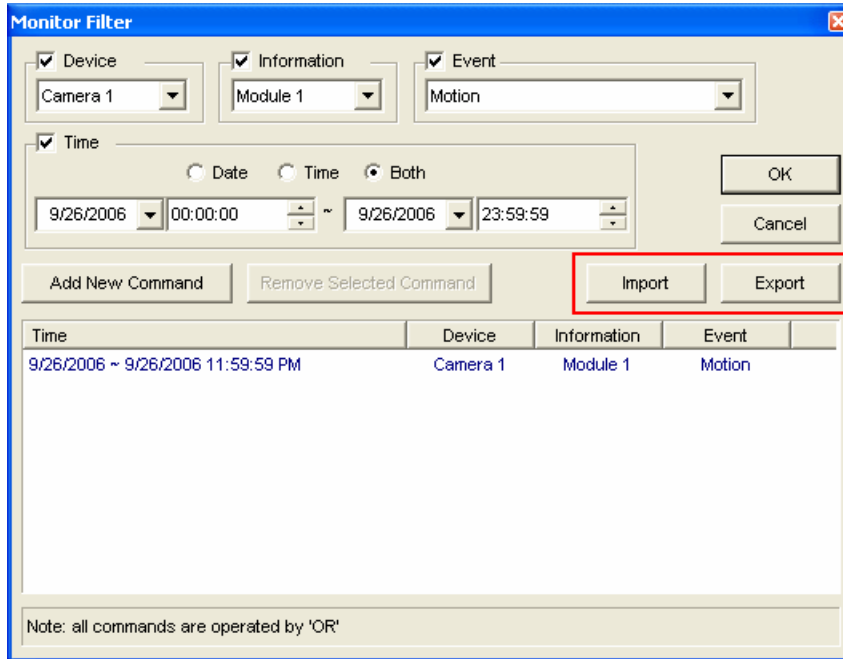

**Figure 4-21**

3. Click the **Import** or **Export** button to start the file transfer.

---

**Note:** This feature is only available in version 8.1 or later. If you want to export the configurations to the older version, it is not applicable.

---



## POS Filter Setup

You can use the POS Filter function in the Advanced Log Browser to locate the desired transaction data.

- **Filter the conditions in below to the selected POS table:** Apply the filter configurations to the selected POS devices.
- **Period between:** Set the employee IDs or names for filtering.
- **Import / Export:** Import or export the POS Filter configurations.

**Pos Filter**

Filter the conditions in below to the selected POS table

1  2  3  4  5  6  7  8  9  10  11  12  13  14  15  16

Sort by: ID

Clear All Select All

Content

Period between: ~

Event  Note

Time

Date  Time  Both

2006/09/25 00:00:00 ~ 2006/09/27 23:59:59

OK Cancel

Advance Search

Add New Command Remove Selected Command Import Export

Time	Content	Event	Note
9/25/2006 ~ 9/27/2006 11:59:59 PM			

Note: all commands are operated by 'OR'

**Figure 4-22**

## Advanced Setup

The **Setting** button on the Function Panel (No. 5, Figure 4-2) allows you to configure (1) Quad View, (2) Thumbnail View, (3) Play Setting, (4) Display and (5) Database / Cache. Click this button to open the System Configuration dialog box.

### [Quad View]

Select four desired cameras to display in Quad View mode.

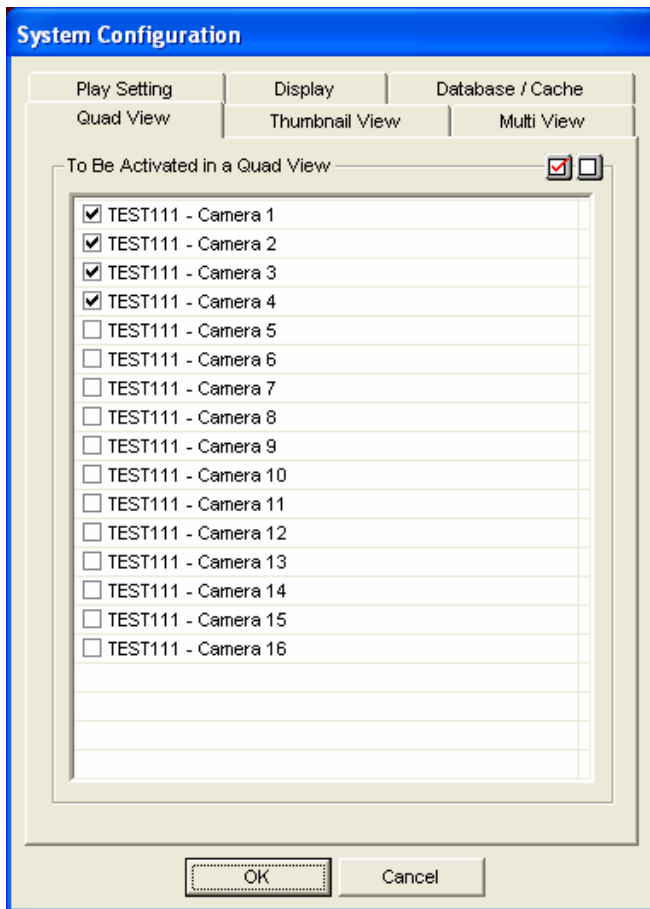

**Figure 4-23**

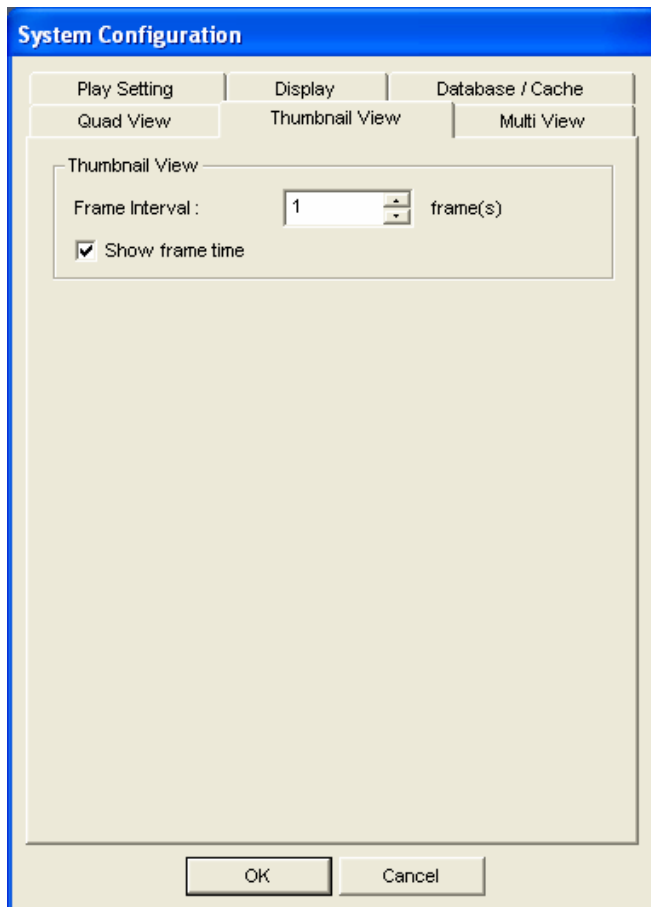
**[Thumbnail View]**

**Figure 4-24**

- **Frame Interval:** Specify the number of frames between each video thumbnail. Set the interval between 1 and 600.
- **Show frame time:** Displays time stamp on each thumbnail.

## [Play Setting]

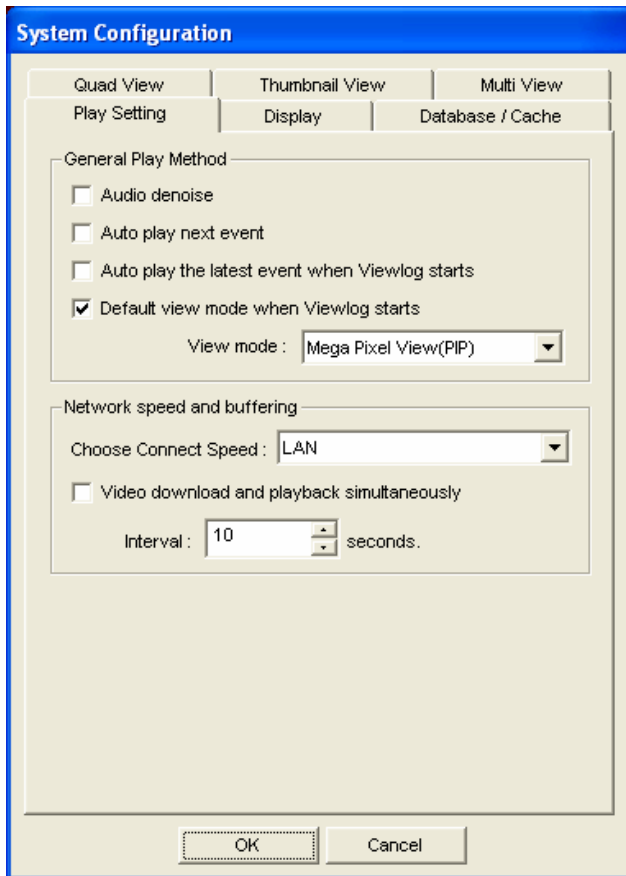

**Figure 4-25**

### [General Play Method]

- **Auto Denoise:** Improves the audio quality during playback without affecting the files.
- **Auto play next event:** The next events can be put in sequence for auto playing.
- **Auto Play the latest event when Viewlog starts:** The latest event starts playing when ViewLog starts.
- **Default view mode when Viewlog starts:** Select the desired view mode at startup.

**[Network Speed and Buffering]** This feature provides network-buffering options to meet your bandwidth needs. This section is only available when the Connect to Remote ViewLog Service feature is enabled. For Remote ViewLog Service, see *Playing Back over Internet Using Remote ViewLog Service* later in this chapter.

- **Choose Connect Speed:** Select your connection speed for LAN, Broadband or Narrowband. The selection will bring up default settings in the Advanced Play Method and Network Buffering options.
- **Video download and playback simultaneously:** This method is recommended for broadband and busy network. It partially downloads and stores a file in a buffer before it begins to play. Specify the interval between downloaded files.

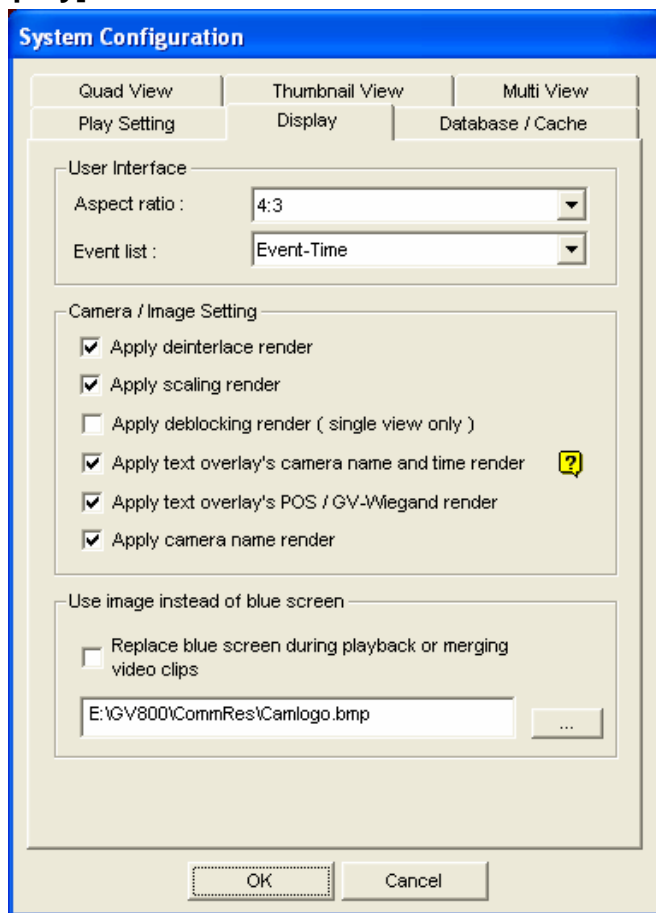
**[Display]****Figure 4-26****[User Interface]**

- **Aspect Ratio:** Select the ratio between the width of the image and the height of the image.
- **Event List:** Click the drop-down list to select the display layout of Video Event List. You can select to display Event Time only, Event Time together with Total Frame, Event Time together with Total Time, or Event Time together with File Size.

**[Camera/Image Setting]**

- **Apply De-interlace Render:** Enable the De-interlace function, and then restart ViewLog to apply it.

---

**Note:** This function requires DirectX 9.0C. The De-interlace only works in single view with the resolution of 640 x 480 and 720 x 480.

---

- **Apply Scaling Render:** Select to smoothen mosaic squares when enlarging a playback video. Restart ViewLog to take effect.

---

**Note:** This function requires DirectX 9 and VGA card with the video scaling support. And the scaling only works in single view.

---

- **Apply deblocking render (single view only):** Select to remove the block-like artifacts from low-quality and highly compressed video, greatly increasing the overall quality of video.
- **Apply text overlay's camera name and time render:** Displays the overlaid information of camera ID, location name, date and time on the recorded files. For details, see *Superimposing POS Data onto Camera Screen* in Chapter 3.
- **Apply text overlay's POS / GV Wiegand render:** Displays the overlaid information of POS or GV-Wiegand Capture on the recorded files. For details, see *Superimposing POS Data onto Camera Screen* in Chapter 3.
- **Apply camera name render:** Displays the camera number and name on the screen.

**[Use image instead of blue screen]**

- **Replace blue screen during playback or merging video clips:** Select a customized image in **.jpeg** or **.bmp** format to replace the blue screen. Note the image size is limited to 720 x 576. The blue screen is the default setting for no image in the recording.

**[Database / Cache]**

Specify the duration of event files to be loaded at ViewLog startup.

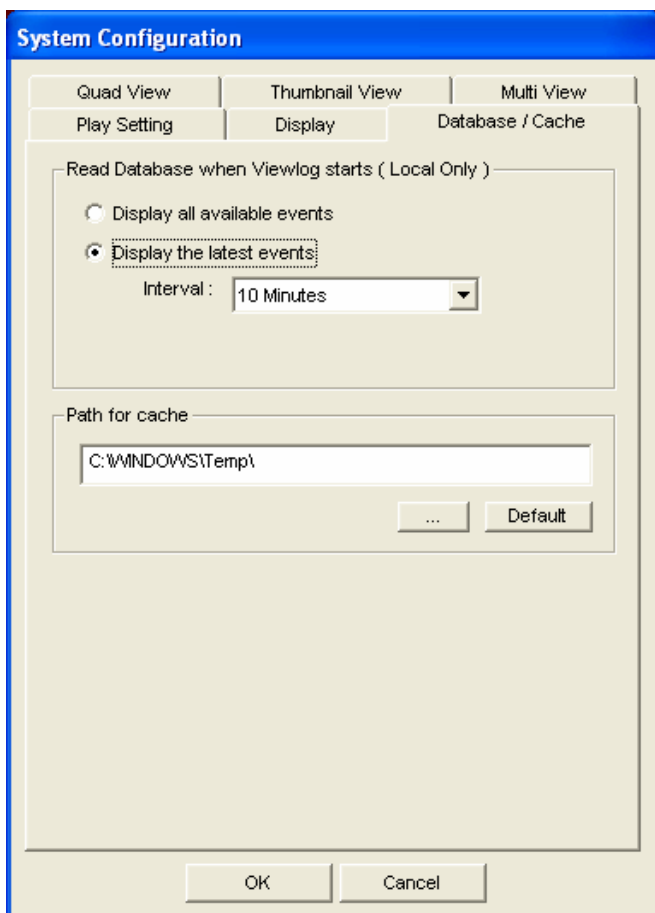

**Figure 4-27**

- **Display all available events:** Load all recorded event files.
- **Display the latest events:** Check this option and select time length of the event files to be loaded.

---

**Note:** If you check the **Display the latest events** option, the Event List will not be refreshed as the latest event is recorded. To refresh the List, click the **Advanced** button, select **Reload Database**, select **DVR**, and then select

- **Default Setting** to reload the specified time length of the event files, or
  - **Read All** to reload all record event files.
- 

**[Path for Cache]** A cache is memory location that is used to store data temporarily, when you are using the function of Save AVI, Export DVD or Network Buffering. If the default path does not have sufficient space for this temporary storage, assign another path by clicking the [...] button.

## Recycling Option for Video Files

You can choose whether to recycle your video files. To apply this function, follow the steps below.

1. Select a desired video event from Video Event List, and then right-click it to call up a menu as shown below.

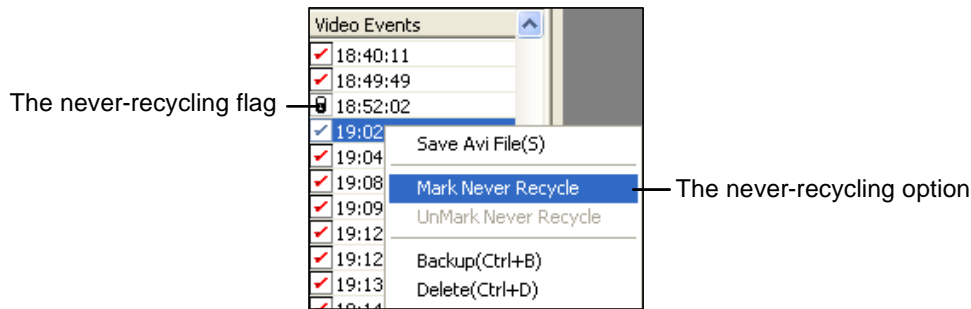

**Figure 4-28**

2. Select the **Mark Never Recycle** option. A never-recycling flag will appear next to the video event.
3. To disable the never-recycling function, right-click the video event again and select **Unmark Never Recycle**.

## Unmarking All Never-Recycling Flags

The above step 3 illustrates how to unmark never-recycling flag one by one. When you like to unmark all the never-recycling flags in certain cameras, follow the steps below.

1. Shut down ViewLog and Main System if they are running.
2. Go to the **Windows Start** menu, select **Programs**, point to the GV folder, and then click **Repair Database Utility**. A valid ID and a password are required.
3. When the Select Camera for Repair Database dialog box appears, select the cameras of video files that you want to unmark their never-recycling flags
4. Click **OK** to open the Repair Database dialog box. See Figure 5-17 in Chapter 5.
5. Click the **Use Default Path** button to unmark all the never-recycling flags.

## Reserving Never-Recycling Flags

If you like to reserve all the never-recycling flags you marked on video events even after repairing the database, check **Reserve Never-recycle Flag** on the Repair Database window before making repairs. See Figure 5-17 in Chapter 5.



## Playing Back over Local Area Network (LAN)

Using LAN ViewLog, it is possible to play back video files across the Local Area Network (LAN). This application provides access to file locations and allows playback in any local computer. Same tasks would be accomplished by using Windows My Network Places but in a much more complicated process.

Before you start, make sure both your system folder and to-be-view video files are made available to network users, done through the proper setup in **Windows Sharing And Security**.

After the folders and files are made available, you must download **LAN ViewLog** and install **GV codec** to your local computer first:

1. At the local computer, go to **Windows My Network Places**. Find the server where the GV-System is located.
2. To download LAN ViewLog, locate **LANViewLogCtrl.exe** from the system folder (Figure 4-29-1), and copy and paste this program to your local computer.
3. To install GV codec, locate the Install Codec folder in the system folder, and run **InstallCodec.exe**.

To view video files:

1. At the local computer, execute **LANViewLogCtrl.exe** to bring up the LAN ViewLog Controller window (Figure 4-29-2).

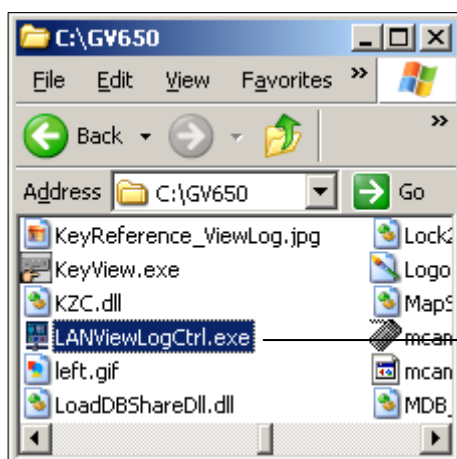

Figure 4-29-1

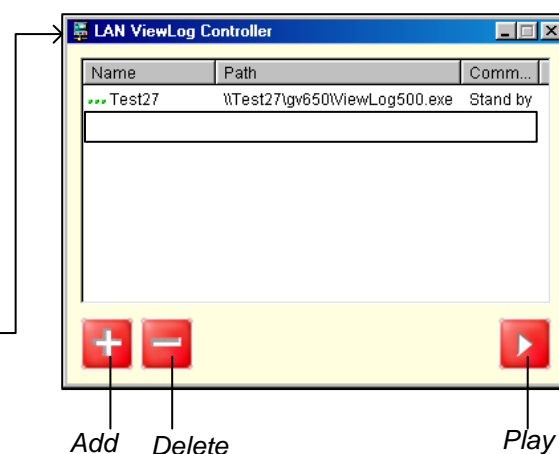
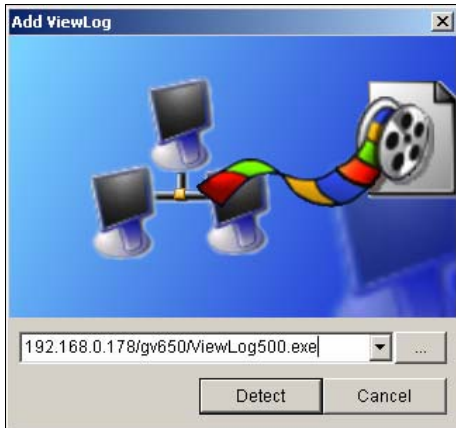

Figure 4-29-2

- Click the **Add** button to bring up the Add ViewLog dialog box.



**Figure 4-30**

- Click [...] the Browse button, and locate **ViewLog500.exe** in the server computer.
- Click the **Detect** button to load video files from the server computer.  
If you see a Red Cross sign instead of green checks (Figure 4-31), go back to your Windows Sharing And Security in the server PC and check if you've made these folders shared for intended PCs.
- Click the **Add** button. A path to the server is now established.

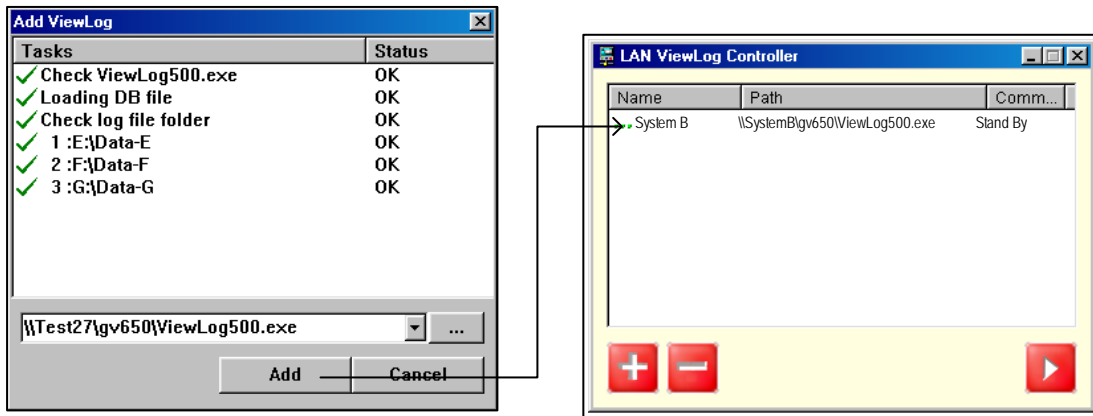

**Figure 4-31**

- Highlight the path, and click the **Play** button to open ViewLog that is loaded with video files. More paths may be added for fast access through the application.

## Playing Back over Internet Using Remote ViewLog Service

Through the Internet, you can retrieve the files from a remote video device, such as GV-System (DVR), Video Server and Compact DVR, and play video back. This feature is made possible through the Remote ViewLog Service. The Remote ViewLog Service features:

- All functions provided by ViewLog are available, such as Backup, Save as AVI, Object Search, Export to DVD Format, Database Files Backup, and so on.
- Capability of disabling certain camera connections under heavy network load
- Resuming file transfers for backup

### Retrieving Recorded Video

Before you can review video recorded on a remote video device, the following function must be enabled at the remote video device to allow access:

- **GV-System (DVR):** Enable **Remote ViewLog Service** on Control Center Server
  - **Video Server, Compact DVR:** Enable the **Remote ViewLog** function
1. On the function panel, click the **Tools** button (No. 6, Figure 4-2), and select **Remote ViewLog Service**. This dialog box appears.

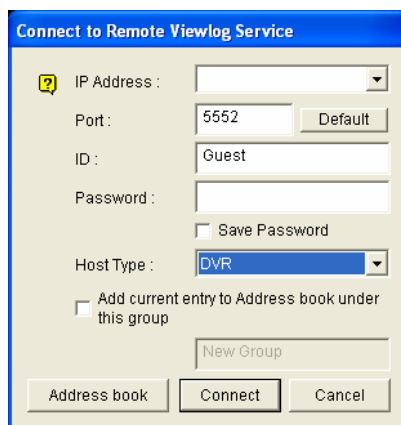

**Figure 4-32**

2. Enter the IP Address, ID and Password of the remote video device. Keep the default port as **5552** or modify it if necessary.
3. In the Host Type, select **DVR, Video Server** or **Compact DVR**.
4. Click the **Connect** button.

When the connection is established, you will see the events of the remote video device appearing on the Event List. Then you can use all ViewLog features for playback.

## Viewing Connection Status

You can view connection status of each camera, and disable certain camera connections when the Internet is overloaded.

On the function panel, click the **Setting** button (No. 5, Figure 4-2), and then click the **Mult View** tab. This dialog box appears.

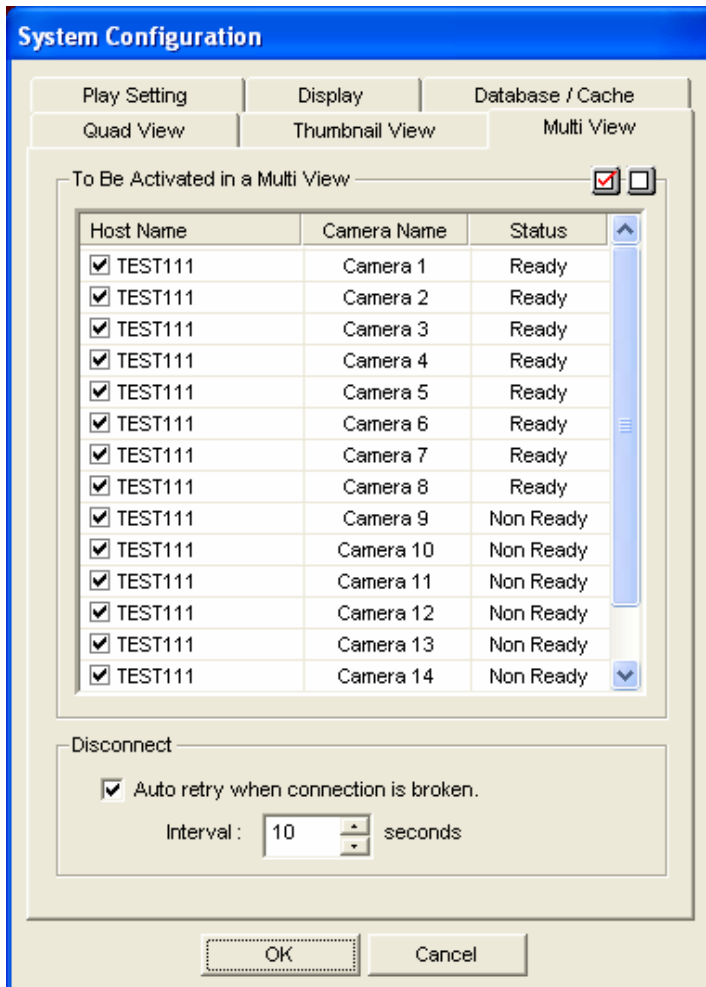

**Figure 4-33**

**[Host Name column]** Indicates the host name of a remote camera. Uncheck to disconnect from one camera.

**[Status column]** The message **Ready** indicates an established connection while **Fail** means a failed connection.

**[Auto retry when connection has broken]** When the connection is broken for a specified time, the system will automatically re-connect to the remote video device.

## Resuming Backup

The Remote ViewLog Service allows you to back up files from a remote video device, such as GV-System (DVR), Video Server and Compact DVR. When the file transfer is interrupted by a network error, you can even resume backup.

1. When the backup is interrupted, this message will appear: *There are x file(s) couldn't be backup. Do you want to keep a log file and backup them later?*
2. Click **Yes**. You will be prompted to save the partial backup file as \*.lv format.
3. To resume backup, click the **Resume** button in the Backup dialog box, and then locate the partial backup file to continue.

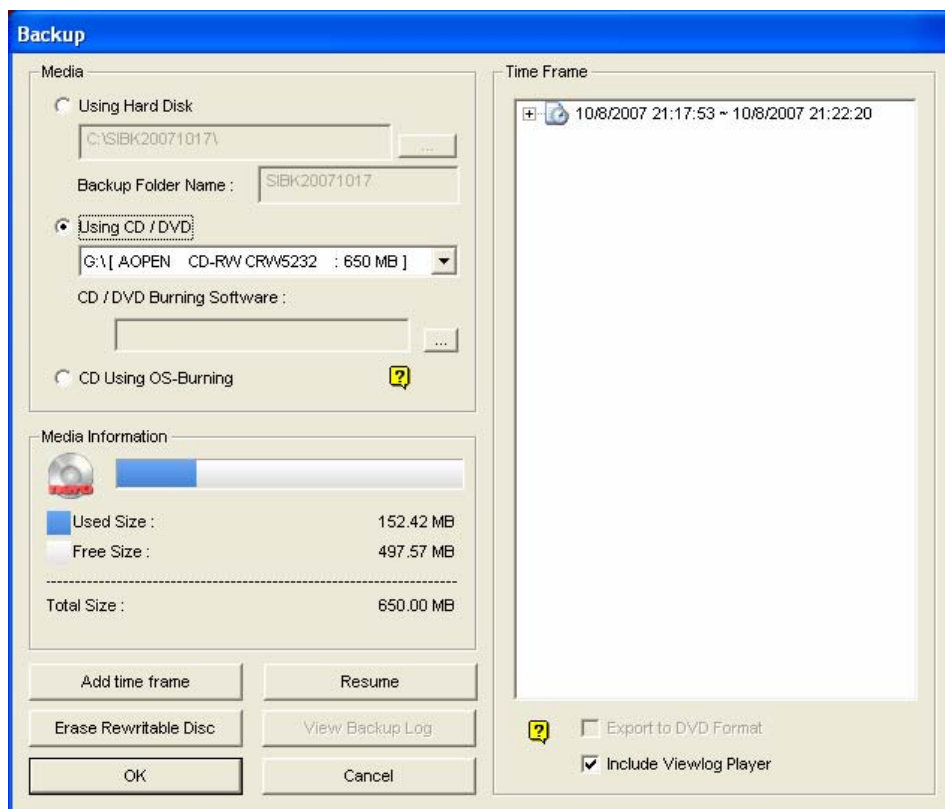
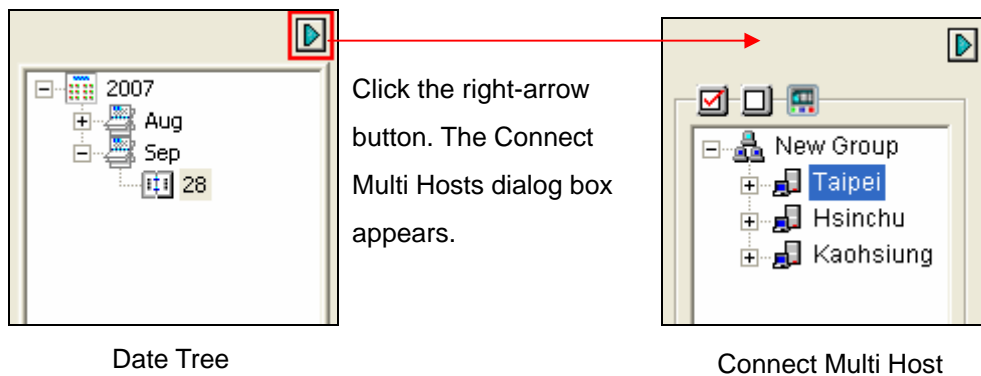

**Figure 4-34**

## Accessing Recordings from Multiple Hosts

You can access the video files of up to 16 cameras from multiple hosts of GV-Systems (DVRs), Video Servers and Compact DVRs over network.

1. To create several hosts, click the **Tools** button (No. 6, Figure 4-2), and select **Address Book**.
2. Click the **Normal** button (No. 9, Figure 4-1) to display the date tree, click the right-arrow button, and select **Connect Multi Host**. The Connect Multi Host dialog box appears.



**Figure 4-35**

3. When this dialog box appears, the ViewLog will automatically detect and connect to the hosts created in the Address Book. Once the connection is built, the available cameras will be displayed.
4. Expand the hosts, select up to 16 cameras from different hosts you want to access, and click the **Connect** button . The selected camera images will appear on the ViewLog player.

## Playing Back over Internet Using Remote Playback

Remote Playback Client (RPB Client) allows client PCs to download history video files from server PCs through Remote Playback Server (RPB Server). Before getting started, make sure the following requirements are met:

OS	Windows 2000, XP, Server 2003, Vista
CPU	Pentium 500 (minimum)
Memory	128 MB RAM
Hard Disk	20 GB (minimum)
VGA	NVIDIA GeForce II 32 MB, 800 x 600 screen resolution (minimum)
Network	TCP/IP

### Working with Remote Playback Server at the Server PC

To establish a connection, first activate RPB Server at one server PC. RPB Server comes with the installation of Main System. Follow these steps to activate it.

1. Go to **Windows Start**, select **Programs**, point to the GV folder, and then select **Remote Playback Server**. This RPB window appears.

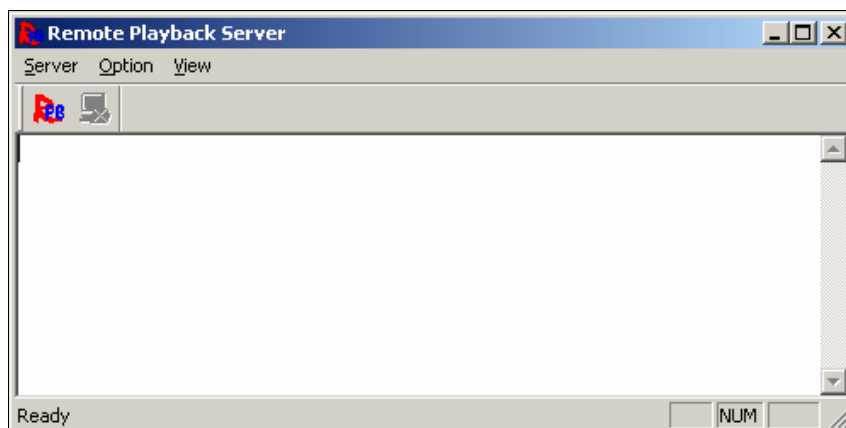

**Figure 4-36**

2. Click the **Start Service** button . A valid ID and Password are required. In the RPB window, you can see the message, for example, "1/4/2005 6:14:36PM Start Sever", indicating when the server is activated.

To stop a connection, click the **End Server** button . A valid ID and Password are required.

To minimize the RPB window in Windows taskbar, select **Option** from the menu bar, and then select **Hide When Minimize**.

## Configuring RPB Server

To configure the RPB Server, select **Option** from the menu bar, and then select **Setup**. This displays the following dialog box.

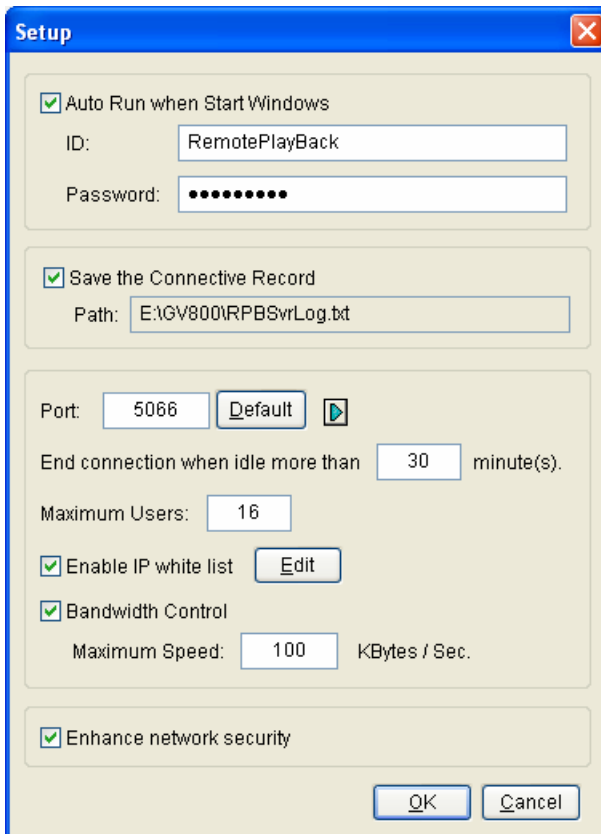

The screenshot shows the 'Setup' dialog box for the RPB Server. It contains several sections with checkboxes and input fields:

- Auto Run when Start Windows:** Checked. ID: RemotePlayBack. Password: [masked].
- Save the Connective Record:** Checked. Path: E:\GV800\RPBSvrLog.txt.
- Port:** 5066. Default button and Arrow button.
- End connection when idle more than:** 30 minute(s).
- Maximum Users:** 16.
- Enable IP white list:** Checked. Edit button.
- Bandwidth Control:** Checked. Maximum Speed: 100 KBytes / Sec.
- Enhance network security:** Checked.

Buttons at the bottom: OK, Cancel.

**Figure 4-37**

**[Auto Run when Start Windows]** Automatically starts RPB Server at Windows startup. Enter an ID and a password that are allowed to use the server.

**[Save the Connective Record]** Check to create a log that keeps the login and logout status of the server. Type a storage path in the Path field.

**[Port]** The default port is 5066. To automatically configure the port on your router by UPnP technology, click the **Arrow** button. For details, see *UPnP Settings* in Chapter 6.

**[End connection when idle more than x minute(s)]** Stops the connection after the assigned idle minutes.

**[Maximum Users]** One RPB Server allows the maximum of 16 connections. You can determine the maximum number of client PCs allowed to log in your RPB Server.

**[Enable IP White List]** Check the item and click **Edit** to create a list of IP addresses only which are allowed to access the RPB server. For the setting details, see *IP White List Settings* in Chapter 6.



**[Bandwidth Control]** Check to prevent overloading on slow network. You can set the bandwidth from 0 to 100,000 Kbytes to transfer in one second.

**[Enhance network security]** Enable to enhance Internet security. Please note when the feature is enabled, the subscribers using earlier version than 7.0 cannot access the RPB any more.

## Working with Remote Playback Client at the Client PC

RPB Client software is to be installed at the client PC, and the software is included in the Surveillance System Software CD. Install and execute **Remote Playback Client Site**.

Camera views from different servers may be displayed in a single 16-channel screen view. Clicking the **Page Select** button turns the screen view to the next page. Maximum two pages (total 32 channels) may be displayed in one RPB Client.

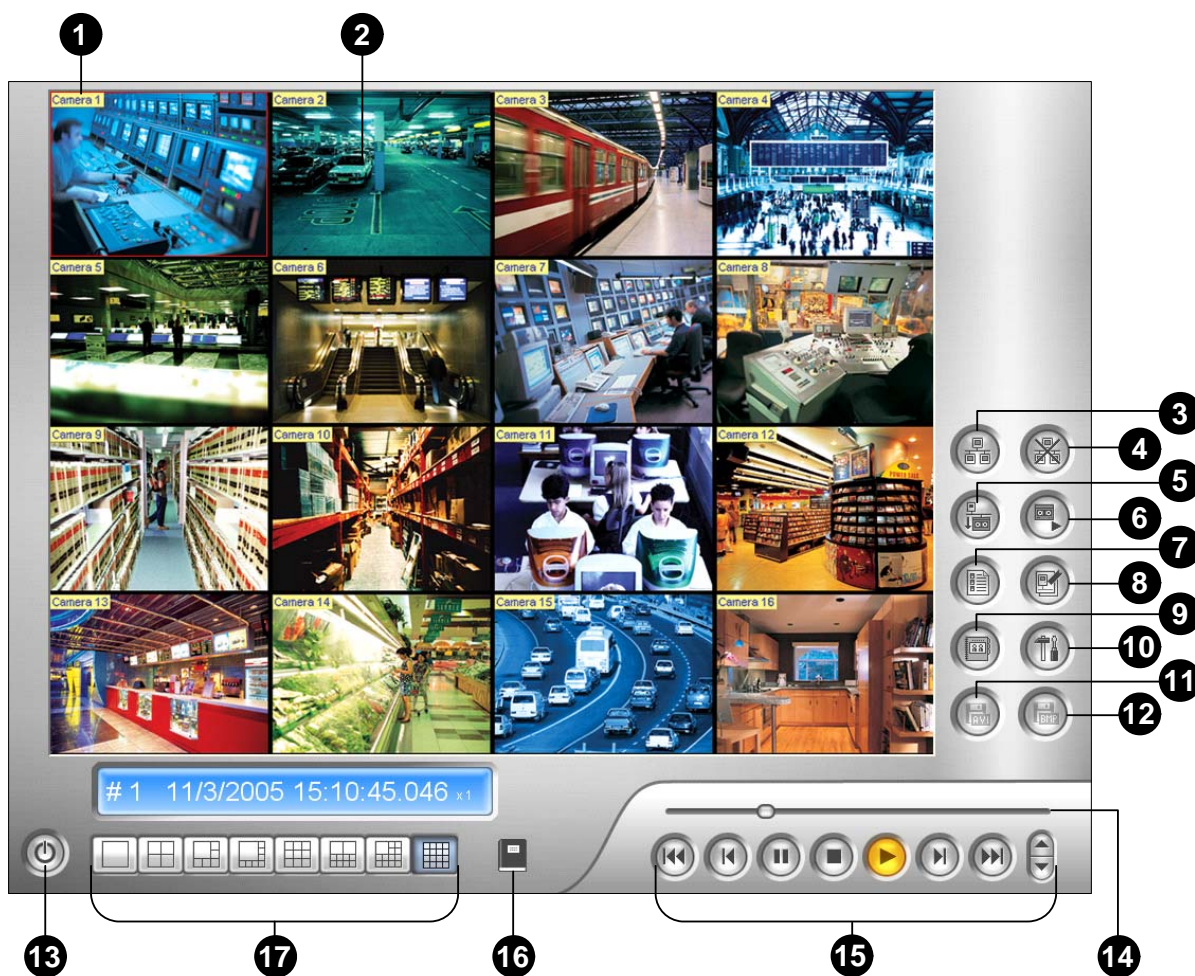

Figure 4-38

The controls in the RPB Client:

No.	Name	Description
1	Camera Name	Indicates the given camera name.
2	Camera View	Displays playback video.
3	Connect	Sets the connection to the RPB server.
4	Disconnect	Closes all or selected connections to the RPB server.
5	Download (Play) Remote Video	Downloads and plays the remote video.
6	Play Local Video	Plays back video files at the client computer.
7	View List	Keeps record of connection activity.
8	Connection Record	Keeps track of the connections.
9	Address Book	Creates a quick connection to the RPB Server.
10	Preference Setting	Sets download status, text display and panel resolution.
11	Save As AVI	Saves a video file as avi or exe format. See <i>Exporting Video</i> earlier in this chapter.
12	Save As BMP	Saves a video image as bmp format.
13	Exit	Closes or minimizes the RPB Client window.
14	Scroll Bar	Moves forward and backward of the playback video.
15	Playback Panel	Contains typical playback buttons.
16	Page Select	Toggles between channels 1~16 and 17~32.
17	Screen Division	Sets the screen divisions.

### Connecting to RPB Server

Click the **Connection** button on RPB Function Panel (No.3, Figure 4-38). This displays the following Connect to dialog box.

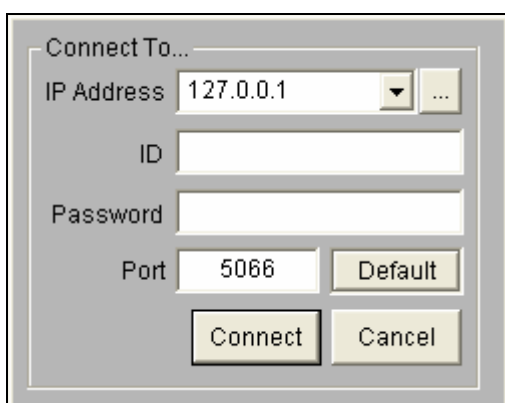

**Figure 4-39**

Enter the login information. You may enter the IP address or the domain name of the RPB server. Alternatively, you may click the drop-down list to find recently visited servers, or click the **Browse** button to select a RPB server from the folder.

## Disconnecting from RPB Server

Click the **Disconnect** button (No.4, Figure 4-38) and select to close all connection by choosing **All Connections**, or close only the selected connections by choosing **Select Disconnection**.

## Downloading and Playing Remote Video

There are two options to download and play remote video: Normal and Advanced.

**[Normal]** Select **Normal** from the **Download (Play) Remote Video** button (No.5, Figure 4-38). This displays the following Search & Download panels.

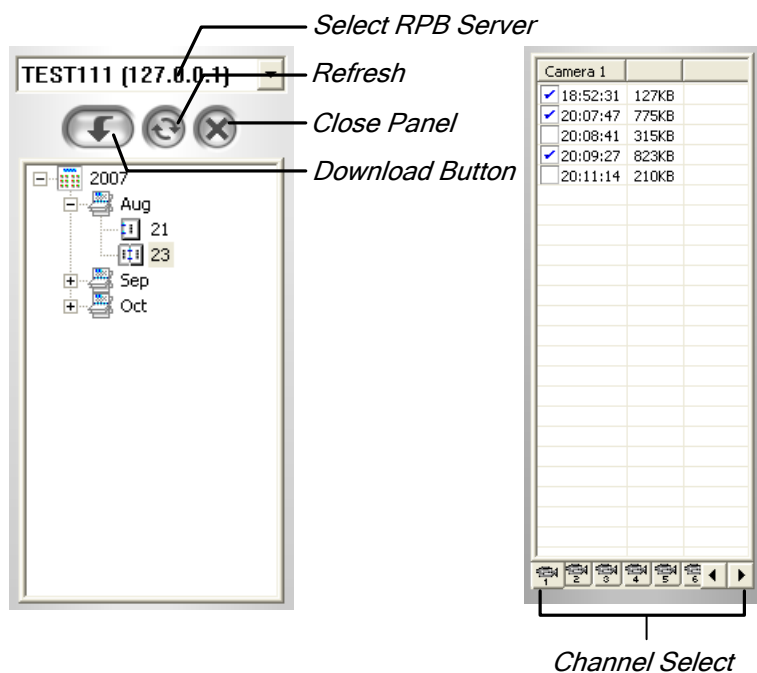
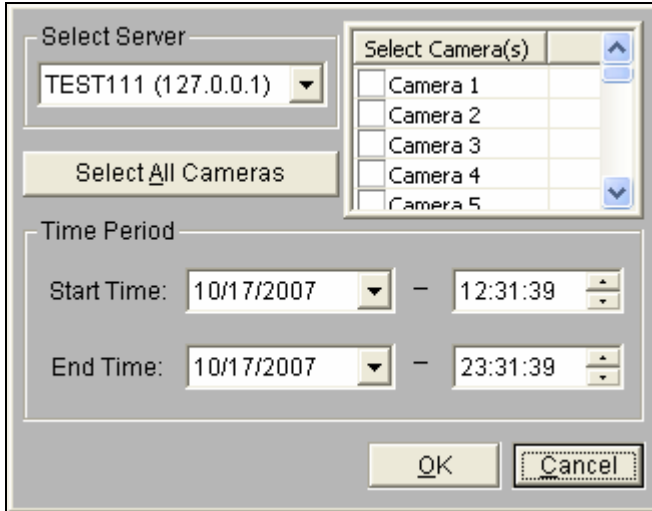

**Figure 4-40**

Follow the steps to search desired files:

1. Select the desired RPB server from the drop-down selection field.
2. Choose the required date from tree folder.
3. Select the required camera from the Channel Select tab, and select the video files from Event List Window.
4. Click the **Download** button to download by the four available options:
  - **Download & Play:** Play the selected files while downloading into the RPB Client.
  - **Just Download:** Download files only.
  - **Just Play:** Play files without downloading them into the RPB Client.
  - **Download & Play (Period):** Download files by frames. Select only one file at a time to apply this function.

**[Advanced]** Select **Advanced** from the **Download (Play) Remote Video** button (No.5, Figure 4-38). This displays this following dialog box.



**Figure 4-41**

The files can be searched by time and date, and by camera. Follow these steps to select cameras to load at specified times:

1. Select the desired RPB Server from the drop-down selection field.
2. Select the required camera from Select Camera(s) window, or click **Select All Cameras** button to select all cameras.
3. Specify the time range. Click **OK** to start the search.

---

**Note:** A warning message may appear if the downloaded file size is greater than the designated storage space.

---

## Playing Local Video

After loading the video files from the server PC to the client PC, click the **Play Local Video** button (No.6, Figure 4-38) to play back the files at the client PC through the RPB Client.

## View List

The list keeps record of connection activity, and it is available in four listing options:

**[Channel List]** Lists all RPB Servers and their respective cameras. Click the **Up and Down** buttons to move up and down the list. The **Disconnect** button ends the connection of the selected camera. The **Exit** button closes the list while all connections remain.

**[Connection List]** Indicates the number of files currently engaged in the connecting activity. The number shown in the Total Works field drops as connection completes. Click the **Work List** to show the type of connecting activity engaged, listed in the Type field. Click the **Back** button to go back to the list; the **Disconnect** button to end the connection; the **Exit** button to close the list.

**[Download List]** Displays a list of files that is currently being downloaded to the RPB Client. The Ratio field shows each file's download progress and the Save Path field shows the location where files are downloaded to.

**[Download History]** Displays a history list of downloaded files in the RPB Client. Double-click the list will play back related files in the RPB monitoring window.

### **Connection Record**

Connection Record keeps track of the connections, which makes your next connection more easily.

**[Save Connective Status]** Saves current connections to a path. When open the RPB Client next time, click the **Connection Record** button and then select **Load Connective Status** (see descriptions below) to look for this path for fast access to current connections.

**[Load Connective Status]** Loads connection status that was previously saved into a file by Save Connective Status, described as above, into the RPB Client.

**[Load Resume File]** If the connections were ended, select this option to continue the downloading process.

## Address Book

The Address Book not only keeps connection information about the RPB sever, but also allows quick connection and auto login to the RPB server. Follow these steps to create an entry in Address Book:

Click the **Address Book** button (No.9, Figure 4-38) to bring up the following dialog box.

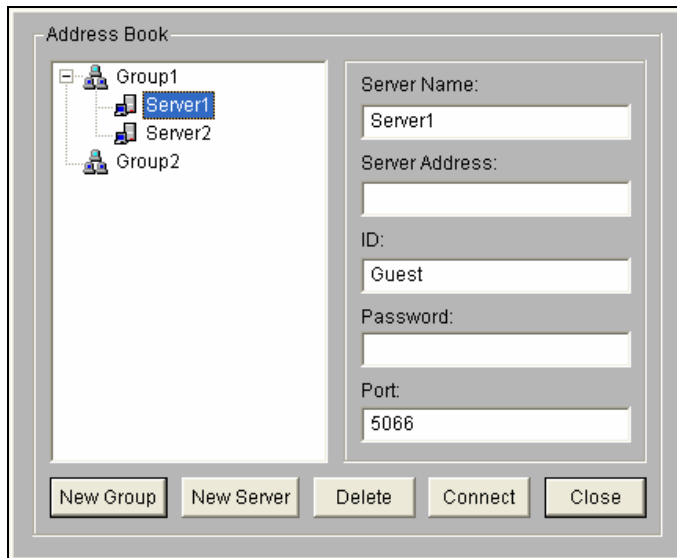

**Figure 4-42**

Click the **New Server** button and provide information to the fields:

- **Server Name:** Give a descriptive name to the server.
- **Server Address:** Enter the IP address or domain name of the server.
- **ID:** Enter an ID that was already created in the server.
- **Password:** Enter the password associated with the ID.
- **Port:** Use the default port 5066, unless otherwise necessary.

You may create a group (click the **New Group** button) before adding any user. Click on any group, and then click the **New Server** button to add users to that group.

Click the **Close** button to finish the setup; **Delete** to remove the entry from Address Book; **Connect** to connect the RPB Client to the RPB Server instantly.

## Preference Settings

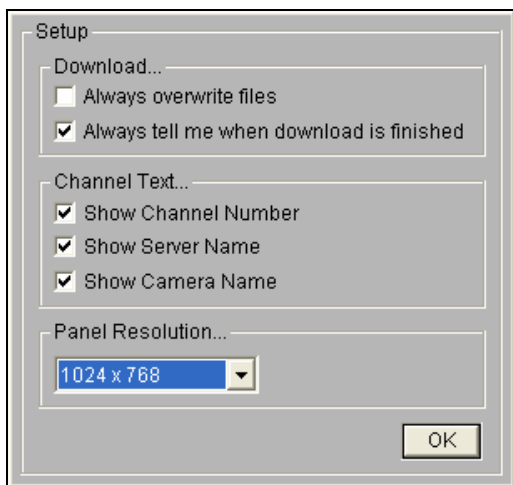

Figure 4-43

**[Download]** The options allow you to specify how your files are saved when your storage space is full.

**[Channel Text]** The selections determine the effect you want your camera view to display.

**[Panel Resolution]** Select the screen resolution of the RPB Client window.

## RPB Client Playback Control Panel

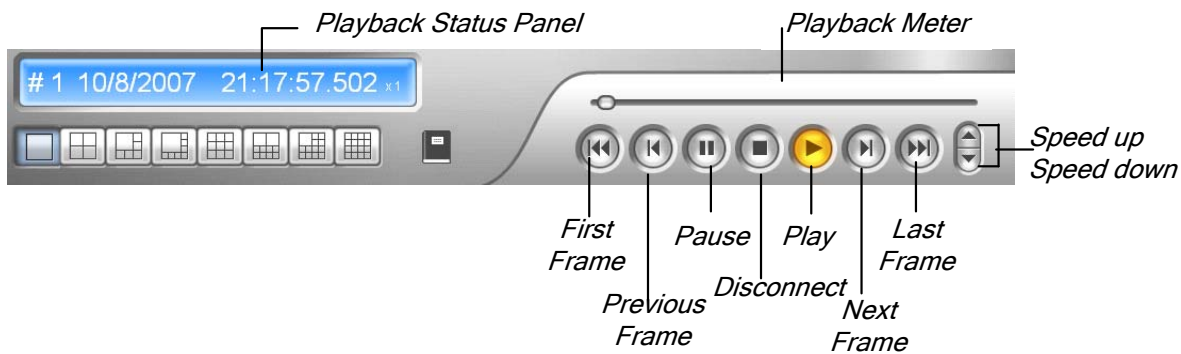
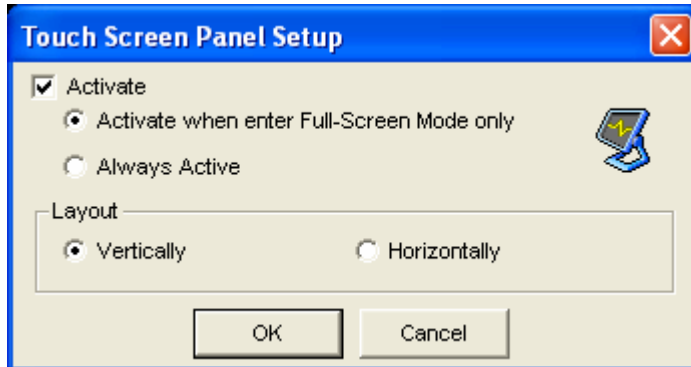

Figure 4-44

## Touch Screen Support

By the touch of a finger, the touch screen panel allows you to change screen divisions, switch to full screen and close the ViewLog screen.

1. Click the **Tools** button (No.6, Figure 4-2), point to **Tool Kit**, select **Touch Screen Panel**, and click **Panel Setup**. This dialog box appears.



**Figure 4-45**

2. Click **Active** to have these options:
  - **Active when enter Full-Screen Mode only:** Launches automatically the panel when the full screen view is applied.
  - **Always Active:** Always displays on the ViewLog screen.
  - **Layout:** Select a vertical or horizontal panel.
3. Click **OK** for the above settings.
4. To activate the panel, click the **Tools** button, point to **Tool Kit**, select **Touch Screen Panel**, and click **Panel Active**.
5. At the upper left corner of the screen, an information window indicating date, time and storage space will appear. Right-click it to open this touch panel.



**Figure 4-46**



## Fast Key Reference

To view the fast key list, click the **Tools** button (No.6, Figure 4-2), point to **Took Kit**, and then select **Fast Key**. The ViewLog fast key list appears.

## Specifications

Feature	Notes
Support for Defogging	Yes (4 channels)
Support for Stabilizer	Yes (4 channels)
Support for PIP View	Yes
Support for PAP View	Yes
Support for Panorama View	Yes (4 sets of Panorama View )
Videos Exported as .AVE Files	Yes
Object Search	Yes

## Chapter 5

---

<b>Backing Up and Deleting Files .....</b>	<b>225</b>
<b>Backing Up Files Using Backup System.....</b>	<b>225</b>
<b>Backing Up Log Data Using System Log .....</b>	<b>229</b>
<b>Backing Up Files Using ViewLog.....</b>	<b>230</b>
<b>Splitting Files for Backup onto Multiple Discs .....</b>	<b>233</b>
<b>Backing Up at the Client PC .....</b>	<b>235</b>
<b>Deleting Files Using Backup System .....</b>	<b>236</b>
<b>Deleting Files Using ViewLog .....</b>	<b>237</b>
<b>Repairing Damaged File Paths.....</b>	<b>238</b>
<b>Repairing Damaged Video Files .....</b>	<b>239</b>



- Click the **Backup** button on the toolbar to bring up the following Backup Log dialog box. Alternatively, you may click **Log** and select **Backup** from the menu bar.

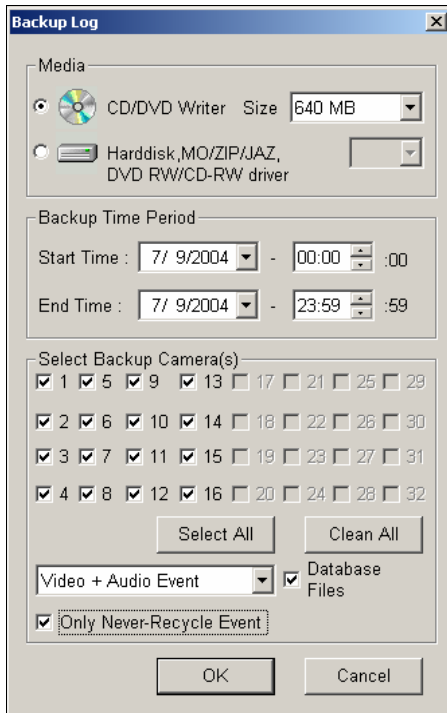

**Figure 5-2 Backup Log**

**[Media]** Select the media where you want to back up the files.

**[Backup Time Period]** Specify a time period for backup. The minimum time for backup is 1 minute.

**[Select Backup Camera(s)]** Select desired cameras for backup

- **The drop-down list:** Select the types of video events for backup. Back up video and audio events together, video events only, or audio event only.
- **Database Files:** Check this item to back up the files from System Log.
- **Only Never-Recycle Event:** Check this item only to back up the never-recycle events.

3. After the above settings, click **OK** to bring up the following window. It shows the information about the backup files.

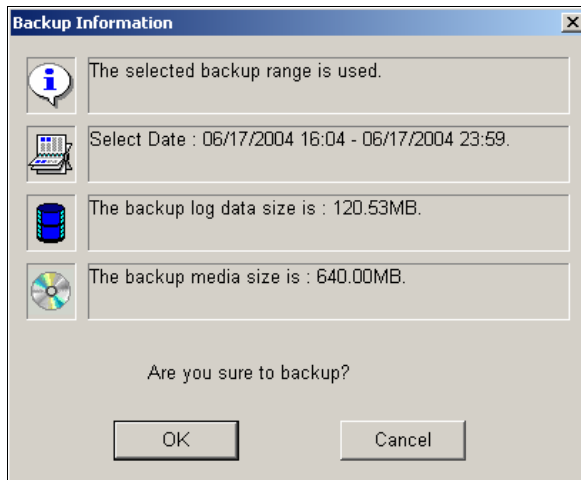

**Figure 5-3 Backup Information**

4. Click **OK** if all the information stated is correct. This pastes all copied files to the CD writer.
5. When the following message appears, click **OK**.

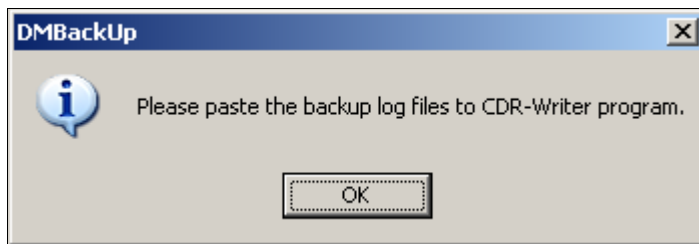

**Figure 5-4**

- Open your CD writer program. Right-click anywhere on the program interface to call up a menu, and then select **Paste**.



*Figure 5-5 Pasting files*

- After pasting, you can see backup files pasted onto the CD writer program.

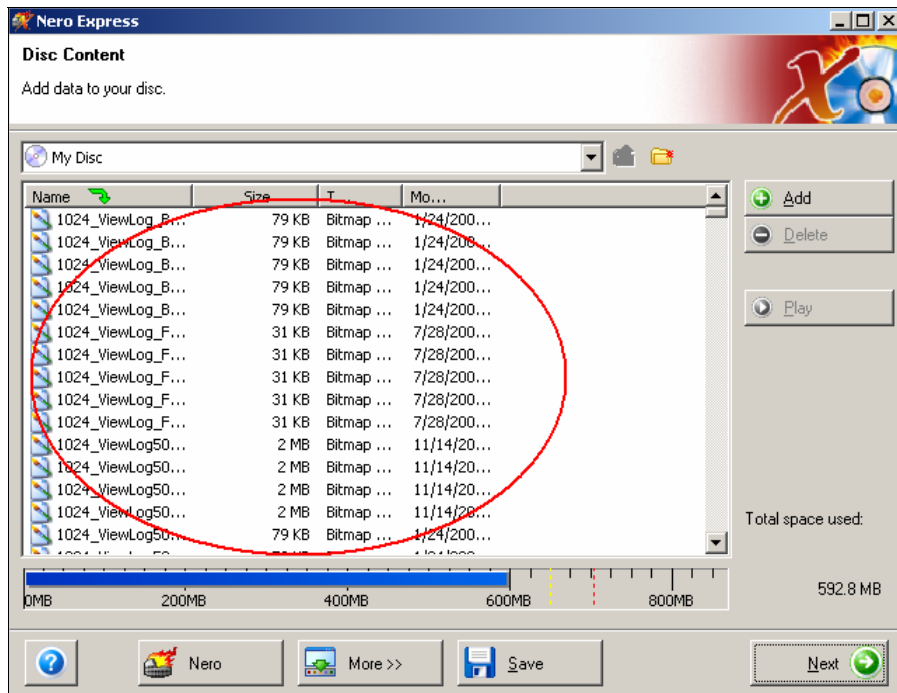

*Figure 5-6 The pasted files on the CD writer program*

- You can then start to copy these files onto your CD-R.

## Backing Up Log Data Using System Log

Using the System Log, you can back up all log data or filtered data based on criteria.

1. To open the System Log, click the **ViewLog** button on the main screen, and select **System Log**.
2. To open the Advanced Log Browser, click the  icon at the top left corner on the System Log window.
3. Click the **Backup** button on the toolbar. This dialog box appears.

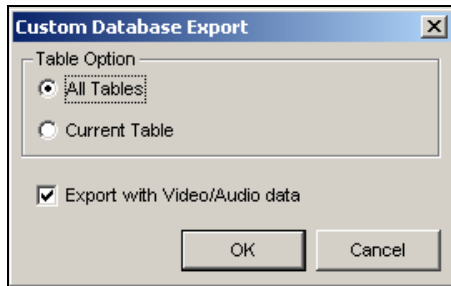

**Figure 5-7**

### [Table Option]

- **All Tables:** Backs up all log data.
- **Current Table:** Backs up only the log table you are currently at.

**[Export with Video/Audio data]** Backs up video/audio attachments with log data.

4. Click **OK**. The Backup dialog box (Figure 5-8) appears.
5. In the Media section, select the destination to back up the log files, and then click **OK** to back up.

---

### Note:

- To back up the filtered data, use the **Filter** function to define search criteria first.
  - To open the backup data, run **EZSysLog.exe** from the backup file.
-

## Backing Up Files Using ViewLog

Using ViewLog, you have three backup options:

- Back up to hard disk
- Create CD/DVD using a third party software, e.g. Nero, Roxio, etc.
- Create CD using Windows XP / Server 2003 / Vista inbuilt burning software

To back up files:

1. On the function panel, click the **Tools** button, and then select **Backup**. This dialog box appears.

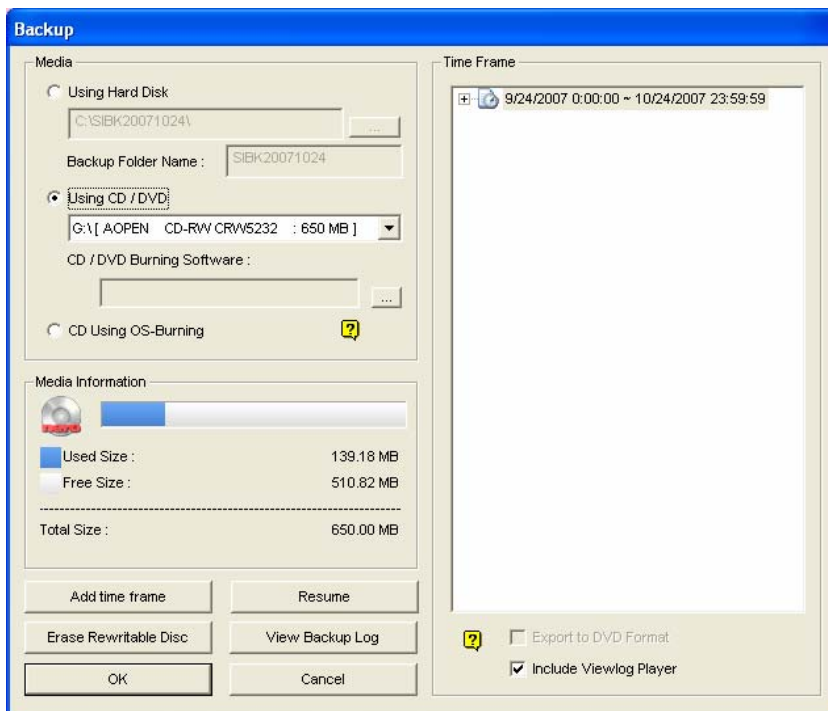

**Figure 5-8**

2. Select a destination media to back up files.

### [Media]

- **Using Hard Disk:** Click to back up files to the hard disk you select. Click the [...] button to select the desired hard disk.
- **Backup Folder Name:** Enter a desired name for the backup folder.
- **Using CD/DVD:** Click to back up files to the CD or DVD media using the third-party software.
  - Click the [...] button to assign the desired burning software (.exe file). When you click **OK** on the Backup dialog box (Figure 5-8), the system will ask you to paste the backup files to the CDR-Writer program (Figure 5-4), and call up the assigned burning software for you to paste and backup files.



- If Nero software of version 6.6.0.1 or later is installed, the backup feature provides the direct burn function. It allows you to directly burn the files onto CD/DVD without the steps of assigning the burning software and pasting the backup files to the CDR-Writer program.
- If Nero software of version 7.0 is installed, the backup feature allows you to directly burn the files to blu-ray media.
- **Using OS-Burning:** This option is only available when you use Windows XP or Server 2003. It burns files using the inbuilt software of the operation system. Note that your hard disk needs at least 1 G buffer space.

**[Media Information]** This section indicates free and used space on CD/DVD media or the local disk.

3. Click the **Add Time Frame** button to define a time period for backup.

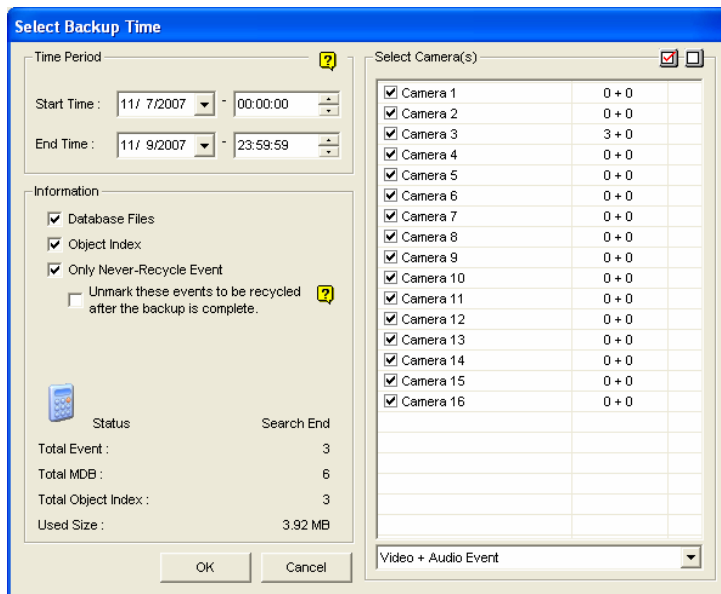

Figure 5-9

**[Time Period]** Specify the time periods for backup.

**[Select Camera(s)]** Click to select the camera(s) for backup. The number of video and audio files of each camera is indicated respectively, e.g. "Camera 1 1+0" means Camera 1 has 1 video file and 0 audio file.

- **Video + Audio drop-down list:** Select the types of video events for backup.

**[Information]**

- **Database Files:** Click to back up the files from System Log.
- **Object Index:** Click to back up the Object Index files.
- **Only Never-Recycle Event:** Click to only back up the never-recycle events.

- **Unmark these events to be recycled after the backup is complete:** After the backup is complete, the never-recycle events will be unmarked for recycling. Please note if the first file in the database has been marked and then unmarked in this condition, the first file will be deleted automatically.
  - **The Status and Search End section:** Indicates the number of backup files and their total size. (Total MDB refers to the System Log files.)
4. Click **OK** to add the schedule. You can repeat step 3 to create up to 10 periods of time.
  5. Click **OK** on the Backup dialog box for backup.

**Tip:** If you just want to back up a specific event or several events of one day, select the event or multiple events on the Video Event list, and right-click to select **Backup**. The Select Backup Time dialog box will then appear, and you can follow the steps described above to back up files without setting up the time period.

---

**Note:**

1. If you are unable to record a CD, make sure the CD recording is enabled in your CD burner: open **My Computer**, right-click the CD Drive icon, click **Properties**, click the **Recording** tab, and then check **Enable CD recording on the drive**.
  2. The **Export to DVD Format** option, at the right bottom of Backup dialog box (Figure 5-8), outputs your files in DVD movie format, meaning that it will play in any DVD player that supports writable DVD disks. To enable this option, MPEG2 files recorded by the GV-Hybrid DVR Card / GV-2004 Card / GV-2008 Card need to be selected first (see the Select Camera(s) option), and a DVD±RW disk is required as well.
-

## Splitting Files for Backup onto Multiple Discs

When the size of the backup files exceeds the disc space limit, the ViewLog can automatically split the files to be burned onto multiple discs. For this feature to work, **Nero 6.6.0.1** is required to be installed on your system.

---

**Note:** This feature is not available when

- the **Export to DVD Format** option is enabled to back up files to DVD, or
  - the **CD Using OS-Burning** option is enabled to back up files using the inbuilt burning software of the operating system.
- 

To access this feature, click the **Backup** button. You may choose to include the ViewLog player in the backup files or not.

### Excluding ViewLog Player in the Backup Files

If you choose not to include the ViewLog player in the backup files, there are two backup modes:

- **Mode 1:** This mode intelligently burns files onto CD/DVD by shifting the complete event(s) to a new CD/DVD if space is not enough on the current CD/DVD. You may see some blue screen images at the beginning or the end of each CD/DVD.
  1. When you start burning, a dialog box appears.



**Figure 5-10**

2. For Mode 1, select **No**. A dialog box indicating the number of required discs for burning appears.



**Figure 5-11**

3. Select **Yes** to start the backup.

- **Mode 2:** This mode will keep some buffers at the end and beginning of each CD/DVD, thus overlapping some videos in the beginning of each CD/DVD from the end of the previous CD/DVD.
  1. When you start burning, a dialog box (Figure 5-10) appears.
  2. For Mode 2, select **Yes**. A dialog box indicating the number of required discs for burning (Figure 5-11) appears.
  3. Select **Yes** to start the backup.

### Including ViewLog Player in the Backup Files

If you choose to include the ViewLog player in to backup files, the **Model 2** backup method will be applied. You may see some overlapping videos in the beginning of each CD/DVD from the end of the previous CD/DVD.

1. To include the ViewLog player in the backup files, check the option of **Include ViewLog Player** at the right bottom of the Backup dialog box.

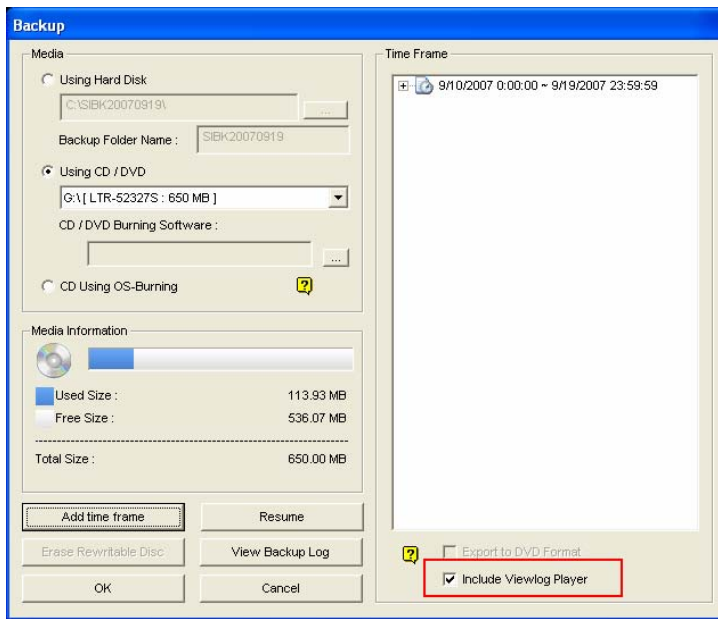

**Figure 5-12**

2. When the backup process starts, a dialog box indicating the number of discs required for backup appears.
3. Click **Yes** to start the backup.

## Backing Up at the Client PC

The program **DMBackUp500.exe**, located in the system folder, makes it possible to back up video files at a client PC. Before you start, make sure both your system folder (GV-650 folder, for example) and video files you wish to save are made available to network users, and done through proper setups in Windows Sharing And Security. After the folder and files are made available, follow these steps:

1. At any client computer, go to **My Network Places** in Windows.
2. Find the server computer where the GV-System is located, and then locate **DMBackUp500.exe** in the system folder, as shown below (assuming that the system is running GV-650 on drive C:).

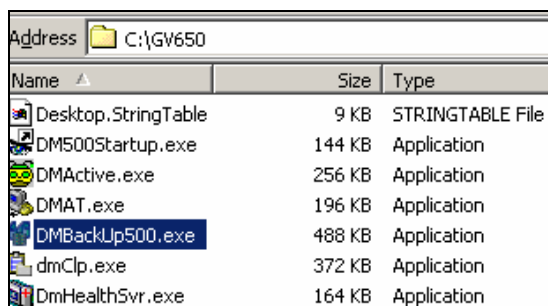

Name	Size	Type
Desktop.StringTable	9 KB	STRINGTABLE File
DM500Startup.exe	144 KB	Application
DMActive.exe	256 KB	Application
DMAT.exe	196 KB	Application
<b>DMBackUp500.exe</b>	488 KB	Application
dmClp.exe	372 KB	Application
DmHealthSvr.exe	164 KB	Application

**Figure 5-13** Executing DMBackUp 500.exe

3. Double-click to run the program.
4. You should be promoted with the DMBackUp dialog box, as shown in Figure 5-1. Follow the same steps as instructed in *Backing Up Files Using Backup System*. This backs up files to the client PC.

## Deleting Files Using Backup System

To delete files using Backup System, follow these steps:

1. In the DMBackUp window, click the **Delete** button. Alternatively, you can click **Log** on the menu bar, and select **Delete** to bring up the following Delete Log dialog box.

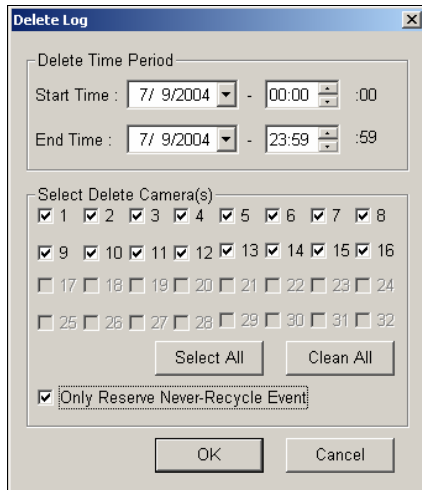

**Figure 5-14** Delete Log

2. Define a time period for the file deletion. The minimum time for deletion is 1 minute.
3. Select the desired camera channels for the file deletion.
4. If you like to reserve the never-recycling events after the deletion, check **Only Reserve Never-Recycle Event**.
5. Click **OK**. This brings up the Delete Information dialog box, indicating how many files will be deleted, and how much storage space will be free.

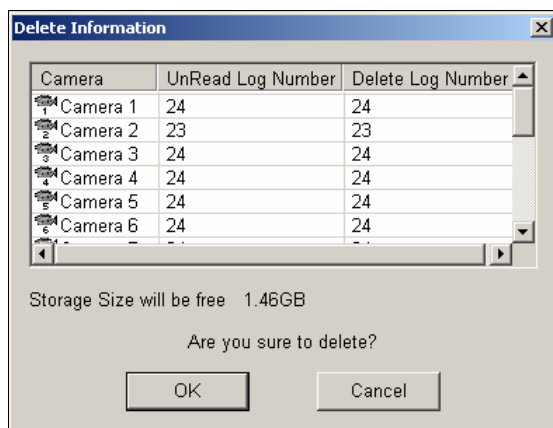

**Figure 5-15** Delete Information

6. Click **OK** to start the deletion.

## Deleting Files Using ViewLog

To delete files using ViewLog, follow these steps:

1. On the function panel, click the **Tools** button (No. 14, Figure 4-2), and then select **Delete**. This dialog box appears.

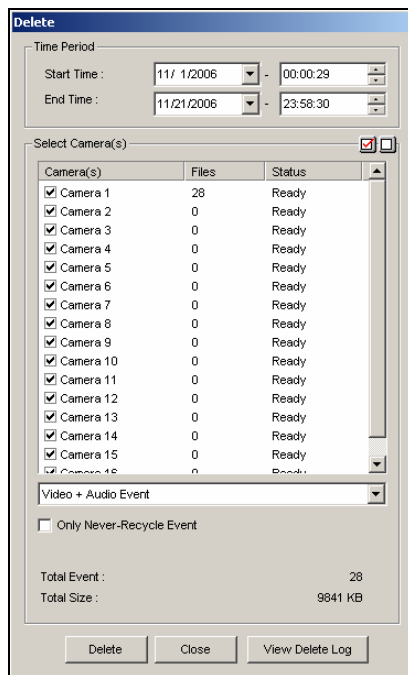

**Figure 5-16**

2. Define the time period for file deletion.
3. Uncheck the cameras, which you don't want to delete the files of.
4. Use the drop-down list to select the types of events to be deleted, e.g. video, audio or both together.
5. If you only want to delete the never-recycle events, check the **Only Never-Recycle Event** option.
6. Click the **Delete** button.

**Tip:** If you just want to delete a specific event or several events within one day, select the event or multiple events on the Video Event list, and right-click to select **Delete**. The Delete dialog box will then appear, and you can follow the steps described above to delete files without setting up the time period.

---

**Note:**

1. If you want to view the history of file deletion, click the **View Delete Log** button.
  2. To view the information of files from a desired camera, right-click the camera and select **Event View**.
-

## Repairing Damaged File Paths

The only way to correctly delete video and audio files is through the operation you've just performed in the previous section. If you move or delete a video file using Windows Explorer or Windows File Manager, GV-System will not know what you have done, unless you've run the **Repair DataBase Utility**. This Utility comes with the installation of Main System. Follow these steps to repair the paths:

1. Go to the **Windows Start** menu, select **Programs**, point to the **GV folder**, and then select the **Repair DataBase Utility**. The valid ID and password are required.
2. When the Select Camera for Repair Database dialog box appears, select the desired cameras to fix the file paths.
3. Click **OK**. This dialog box appears.

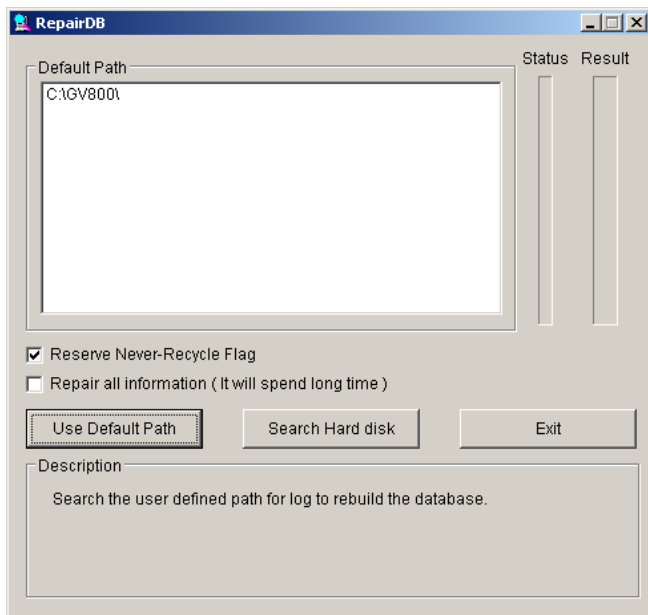

**Figure 5-17** The RepairDB Dialog Box

4. Click the **Use Default Path** button to start the path re-building at the locations specified to save the files in the Main System. For details, see *Log Storage*, in Chapter 1.
5. Click the **Search Hard Disk** button to search the entire PC, and then to re-build paths for the files recorded by GV-System.

---

**Note:**

1. The repair and the search function will not apply to the files that have been renamed manually.
  2. Use this Utility if encountering any of the following scenarios in ViewLog:
    - (1) A question mark appears right before a video file in the Video Event list.
    - (2) When you click the **Playback** button, no video is displayed even a file is selected.
-



## Repairing Damaged Video Files

If the computer has been shut down improperly, e.g. due to power failure, use this function would repair the damaged video files.

**Tip:** When a computer has been shut down improperly, the first thing you do when starting the GV-System is to run **Repair BataBase Utility**. After running the utility, go back to ViewLog and view Video Events. You should be able to play back all video files at this step. However, if what you see is a question mark after clicking on the file, the problem may be that the recording process was interrupted. To repair the file, run the AVI repair utility and follow the steps below.

1. Double-click **AVIRepairAPI.exe** in the GV folder. This dialog box appears.

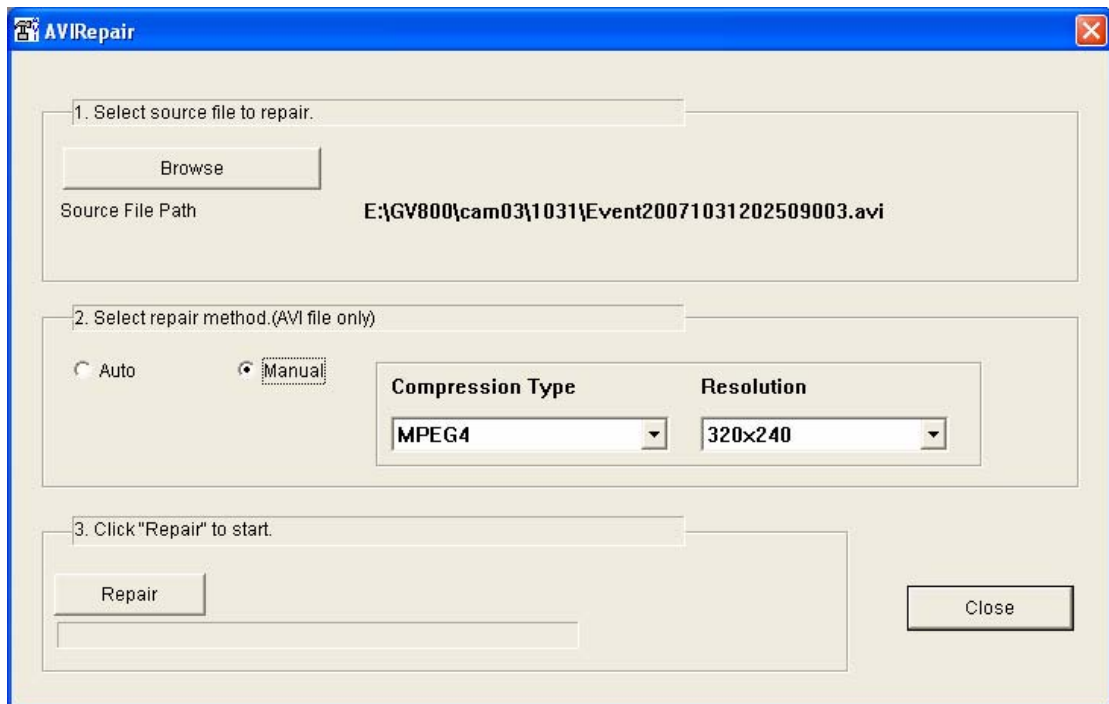

**Figure 5-18**

2. Click the **Browse** button to find the damaged video file.
3. If you know the compression type and resolution of the file, select **Manual** and use the drop-down lists to select the correct codec and resolution. Alternatively, you may select **Auto** and the system will run all combinations for you. Please note it takes longer time to repair with this selection.
4. Click the **Repair** button to start.

5. You may see the distorted image or **No Image** on view screen if an incorrect codec and resolution were chosen. For this, click **No** for the next combination until a complete image appears.

**Distorted Image**



**Figure 5-19**

**No Image**

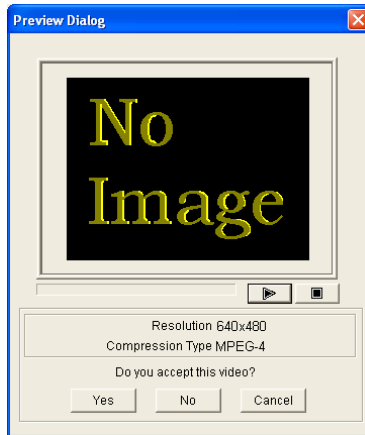

**Figure 5-20**

**Complete Image**

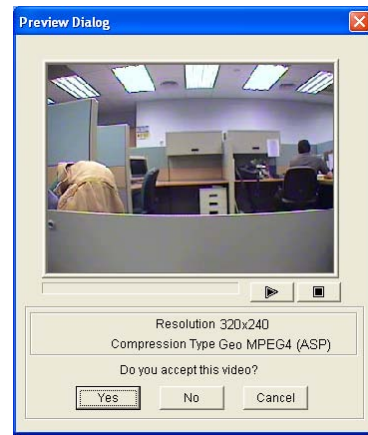

**Figure 5-21**

6. When a complete image is displayed, click the arrow button to preview the file.
7. Click **Yes** to start the repair.
8. Click **Yes** to overwrite or **No** to save this file to another path. Note if you choose **No** in this step, remember to run **Repair DataBase Utility** again after exiting this program.

# Chapter 6

---

## Viewing Live Video Using WebCam.... 243

Configuring WebCam Server .....	243
WebCam Server Settings .....	243
UPnP Settings .....	252
FTP Server Settings .....	255
Network Port Information .....	256
Accessing Live Video Using a Web Browser.....	257
Single View MPEG4 Encoder Viewer.....	259
Control Panel.....	260
Administrating Host Server.....	262
Taking a Snapshot from a Live Video .....	263
Pop-Up Setup .....	264
Video and Audio Configuration .....	265
Exporting Video .....	266
PTZ Control .....	266
I/O Control .....	267
Visual Automation .....	268
Visual PTZ .....	268
Display of Video Resolution.....	269
Picture-in-Picture View .....	269
Picture-and-Picture View .....	269
Image Enhancement .....	270
Remote Configuration.....	270
2-Window MPEG4 Encoder Viewer.....	272
Multi View MPEG4 Encoder Viewer .....	273
Starting Multi View .....	273
Working With the Host Server Window .....	275
Working with Hosts on the Same LAN .....	275
Exporting Video .....	276
Taking a Snapshot from a Live Video .....	276
PTZ Control .....	276
Output Control .....	277
Channel Status Information .....	277
Camera Polling Function .....	278
Two-Way Audio.....	278

Display of Video Resolution.....	278
Multi View Configuration.....	279
Creating a Quick Connection to a Host Server .....	280
Creating Multiple Hosts.....	281
Camera Status.....	283
Host Information .....	284
Remote ViewLog .....	285
JPEG Image Viewer .....	286
Remote Playback on WebCam .....	287
Searching and Playing Back Recorded Files .....	288
Synchronizing Audio with Video Playback.....	289
DirectDraw Setup.....	289
Searching Object Index .....	289
Advanced Search .....	290
Remote ViewLog on WebCam .....	292
Event List Query.....	293
POS Live View on WebCam.....	294
The Remote POS Live View Window .....	294
Instant Playback .....	295
Download Center.....	296
Mobile Phone Applications .....	297
PDA .....	298
I-Mode Phone .....	303
Windows Smartphone .....	305
Symbian Smartphone .....	307
Fast Key Reference.....	309

## Viewing Live Video Using WebCam

With Microsoft Internet Explorer, it is possible to remotely view live videos, download and play back video files, manage systems within the security network, control PTZ camera and I/O devices via the WebCam server.

Before starting the WebCam server, make sure your system meets the following minimum requirements:

OS	Windows 2000, XP, Server 2003, Vista
CPU	Pentium 4, 2.0 GHz
Memory	256 MB
Hard Disk	60 GB
VGA	NVIDIA GeForce II 32 MB, 1024 x 768 screen resolution
Network	TCP/IP
Web Browser	IE 6.0, Netscape Navigator (with limited functionality)
DirectX	Version 9.0 or above

## Configuring WebCam Server

GV-System is built-in with a web sever. Click the **Network** button, and then select **WebCam Server** to display the following Server Setup dialog box.

### WebCam Server Settings

The Server Setup dialog box contains these tabs: (1) General, (2) Server, (3) Video, (4) RPB, (5) Audio, (6) JPG, (7) 3GPP and (8) Mobile.

**[General]**

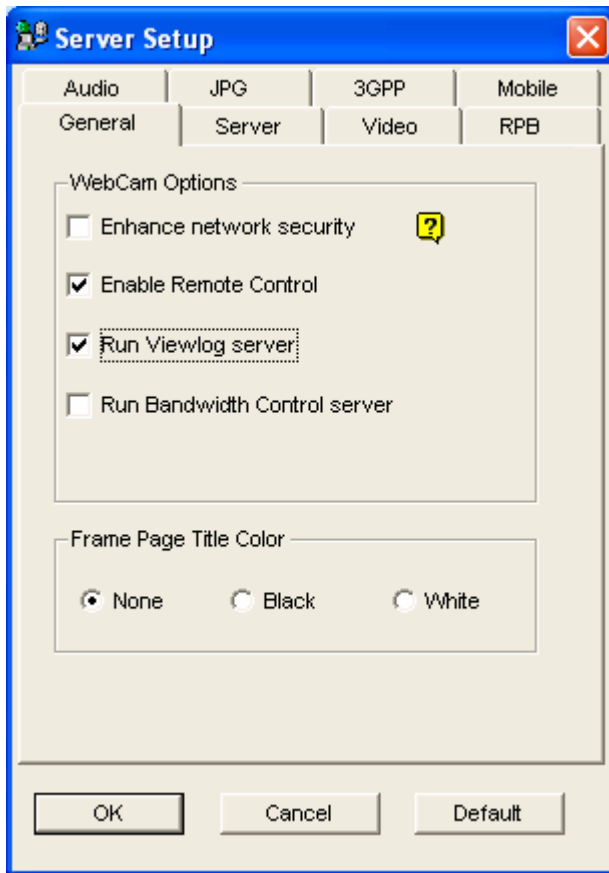

*Figure 6-1 Server Setup- General*

**[WebCam Options]**

- **Enhance network security:** When this option is enabled, it is required to complete a word verification step every time when you log in the WebCam server.
- **Enable Remote Control:** Check this item to use **Remote Configuration** and **Enable/Disable I/O** functions on WebCam.
- **Run Viewlog Server:** Check this item to enable the **Remote ViewLog Service**. See *Remote ViewLog on WebCam* later in this chapter.
- **Run Bandwidth Control Server:** Check this item to enable the **Bandwidth Control Server**. For details, see *Bandwidth Control* in Chapter 10.

**[Frame Page Title Color]** Select the color of date, time and camera stamps on the frame.

---

**Note:** When **Enhance network security** is enabled,

- the users using earlier version than 8.0 cannot access WebCam applications any more, and
  - JPEG/3GPP/Mobile applications will be disabled.
-

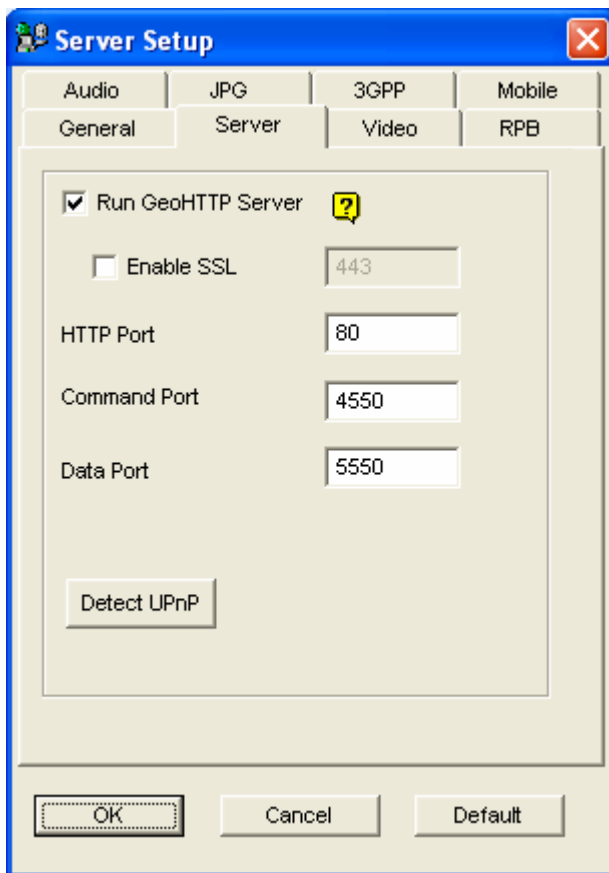
**[Server]**

**Figure 6-2** Server Setup- Server

**[Run GeoHTTP Server]** Enable Geo-developed HTTP server or use your own HTTP server.

Command Port is the port used to access WebCam, and Data Port is the port used to transfer data over Internet.

**[Enable SSL]** Enable the Secure Sockets Layer (SSL) protocol to ensure the security and privacy of Internet connection.

**[Detect UPnP]** For details, see *UPnP Settings* later in this chapter.

[Video]

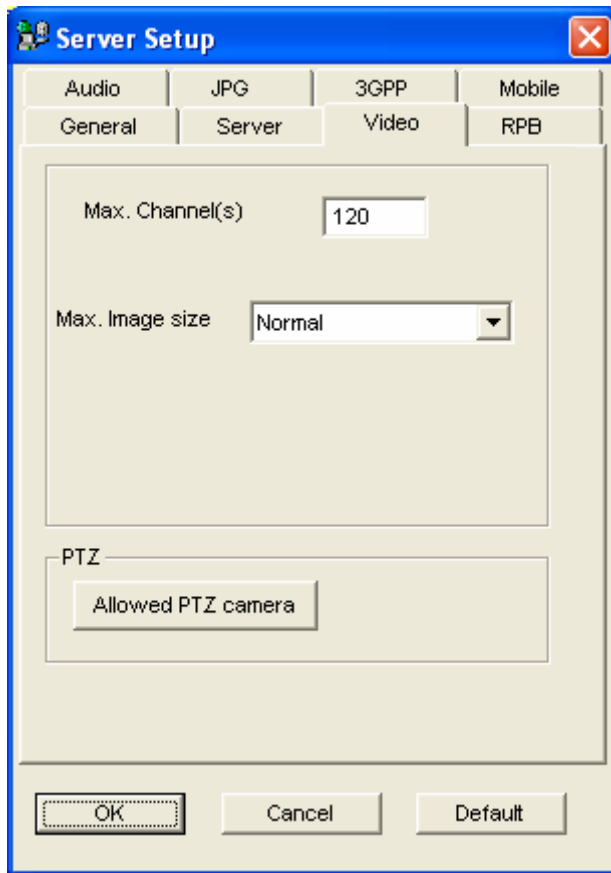

**Figure 6-3** Server Setup- Video

- **Max. Channel(s):** Specify the number of channels allowed to access WebCam, with the upper limit of 200 channels.
- **Max Image size:** Select a resolution. The default resolution on WebCam is **Normal** (320 x 240). If you want to apply the **Middle** (640 x 480 (De-interlace) or 720 x 480 (De-interlace)), **Large** (640 x 480 or 720 x 480) or **Mega Pixel** resolution, you also have to configure Video Source. Click the **Configure** button on the main screen, point to **A/V Setting**, and then select **Video Source**. In the Video Resolution field, select 640 x 240 or higher resolutions, and then click **OK** to apply.
- **Allowed PTZ camera:** The option allows you to control selected PTZ cameras at a remote computer. Click the button and select the desired PTZ cameras to work on WebCam.

---

**Note:** To specify the time length allowed for a guest user to access the WebCam server, click the **Configure** button on the main screen, point to **General Setting**, select **Password Setup**, and select **Local Account Edit**. On the WebCam tab, check the **Limit Connection Time** option and specify the time length. The time range is between 10 and 3600 seconds.

---

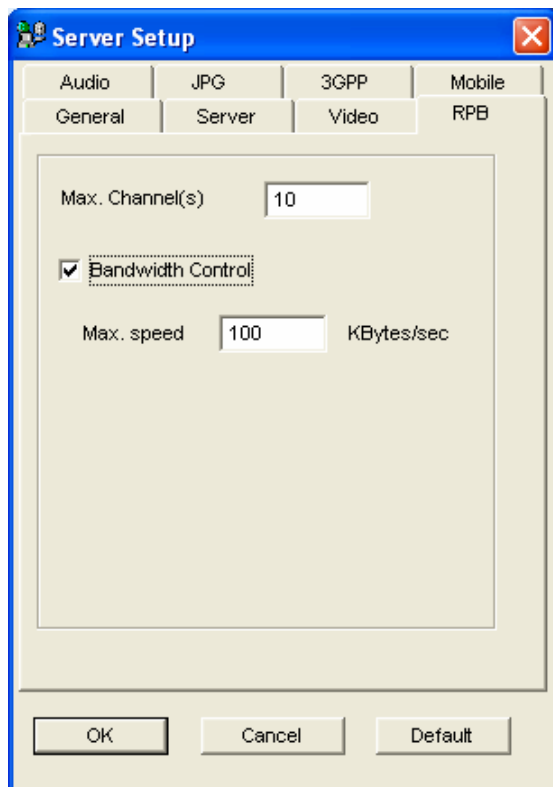

**[RPB]**

**Figure 6-4** Server Setup- RPB

This feature is used to prevent overloading on slower networks.

- **Max. Channel(s):** Specify the number of channels allowed to download to a client PC.
- **Bandwidth Control:** Enable and specify the rate of data to be transferred over network. The option effectively controls the bandwidth being used by the WebCam server.

**[Audio]****Connecting Audio Devices**

Via WebCam, you can access live audio at a remote site and talk to the server site. This feature is useful when the remote site requires speaking to the personnel at the server site in case of emergency. Before using this feature, make sure all the necessary hardware are in place:

1. If you purchase a BNC connector GV-System, connect the audio extend card to the system (see *Installation Guide*). If you purchase a D-type connector GV-System, audio extension cable lines should come available with the D-Type extension cables. For GV-1000, the audio card must be purchased separately.
2. Make sure your sound card is already inside the computer. Connect a multimedia speaker to the audio output of your computer's sound card.
3. Connect a desktop microphone to the input of the audio extension card (or cable line).

## Audio Setup

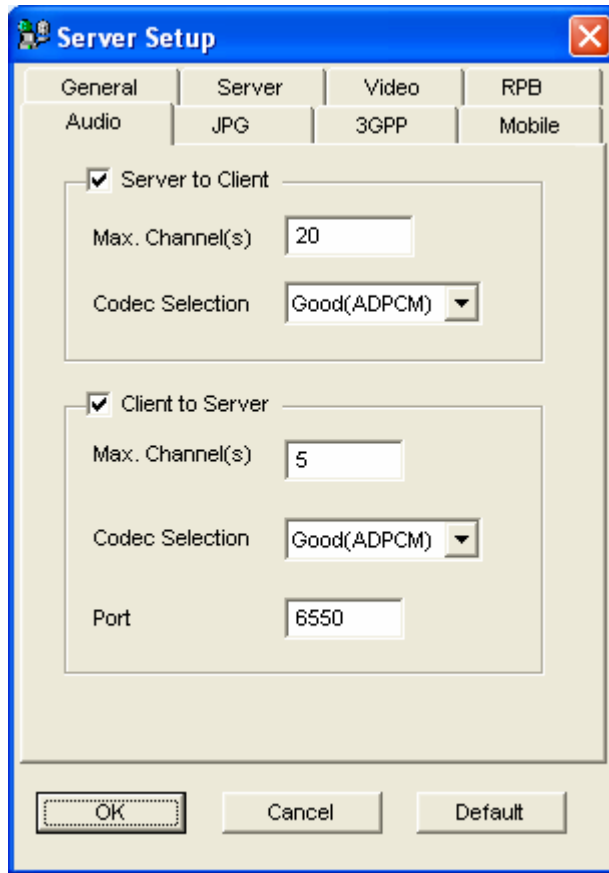

*Figure 6-5 Server Setup- Audio*

**[Server to Client]** Allows a client PC to access live audio from the server site.

- **Max. Channel(s):** Enter the number of client PCs allowed to access live audio, with the upper limit of 40 PCs.
- **Codec Selection:** ADPCM requires 4 KByte bandwidth, while G.723 requires only 0.66 KByte bandwidth. But ADPCM offers much better audio quality than G.723. The audio codec is set to **Good (ADPCM)** by default. Note Windows Vista does not support G.723.

**[Client to Server]** Allows a client PC to speak to the server site.

- **Max. Channel(s):** Enter the number of client PCs allowed to speak to the server site, with the upper limit of 20 PCs.
- **Codec Selection:** The same as the above Codec Selection.
- **Port:** The default audio port is 6550.

---

**Note:** If your server site is installed a firewall, configure the port settings in the firewall as **4550, 5550, 6550** and **80**.

---

[JPG]

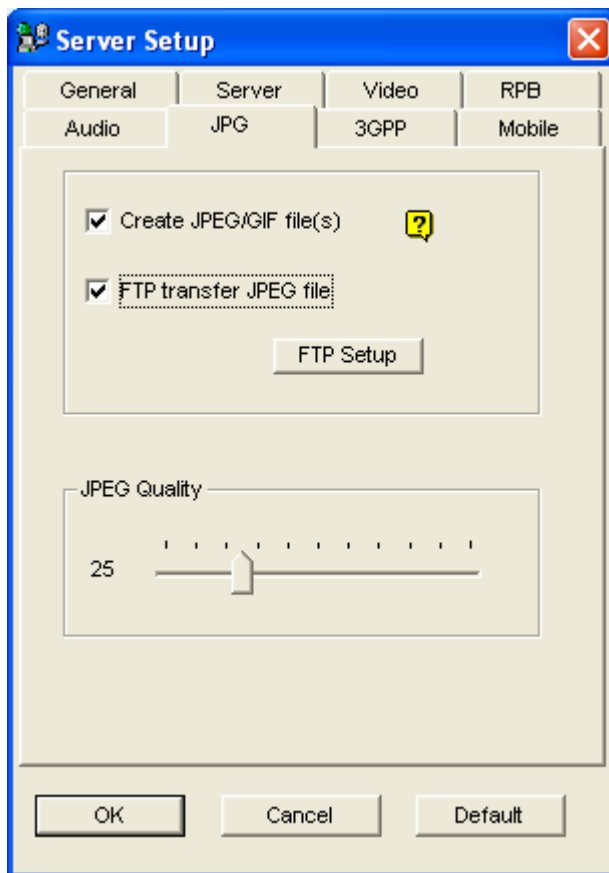
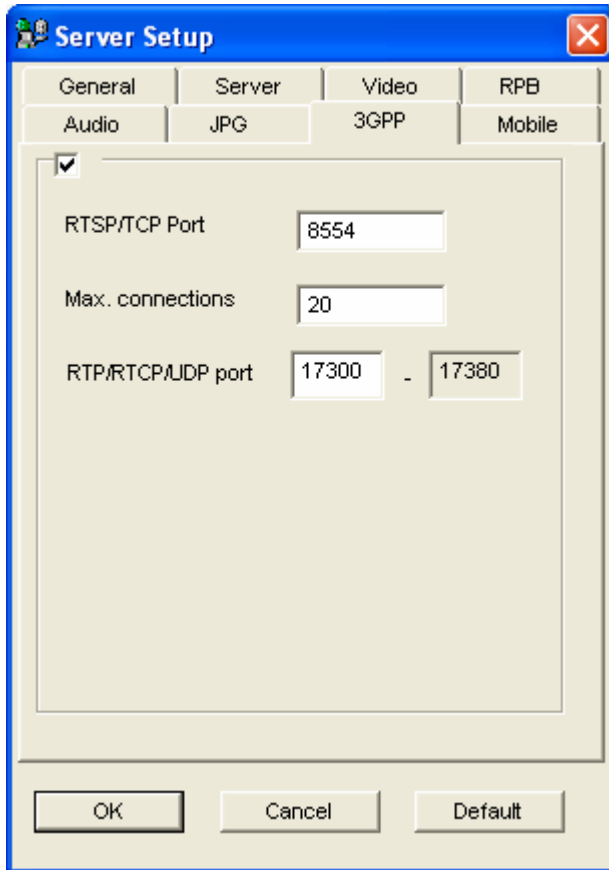

Figure 6-6 Server Setup- JPG

- **Create JPEG/GIF file(s):** Allows the connection to GView (see *Connecting GView to GV-Server*, later in this chapter), i-Mode (see *I-Mode Phone* later in this chapter), and JPEG Image Viewer (see *JPEG Image Viewer* later in this chapter). If the feature is enabled, use the slide bar to adjust JPG image quality. The bigger the number (sliding it towards right), the better the image quality and the bigger image file size.
- **FTP Transfer JPEG file:** Allows you to view the recording files in a folder tree structure. For details, see *FTP Server Settings*, later in this chapter.

## [3GPP]

These settings allow you to stream video and audio on your 3G-enabled mobile phone. For more information on 3G mobile phone connection, please check our website.



**Figure 6-7**

- **RTSP/TCP Port:** The default communication port is 8554.
- **Max. Connections:** Specify the number of users that can connect to this server. Set the number to be between 1 and 100.
- **RTP/RTCP/UDP Port:** The number of ports is limited to 80 in order to enhance the security of the WebCam server during the connection with the 3G-enabled mobile phones. The default range of ports is 17300 to 17380.

---

**Note:** To enable 3G services on your mobile phone, consult your network operator.

---

**[Mobile]**

A separate Mobile Server is provided to integrate the configurations of the mobile phone applications.

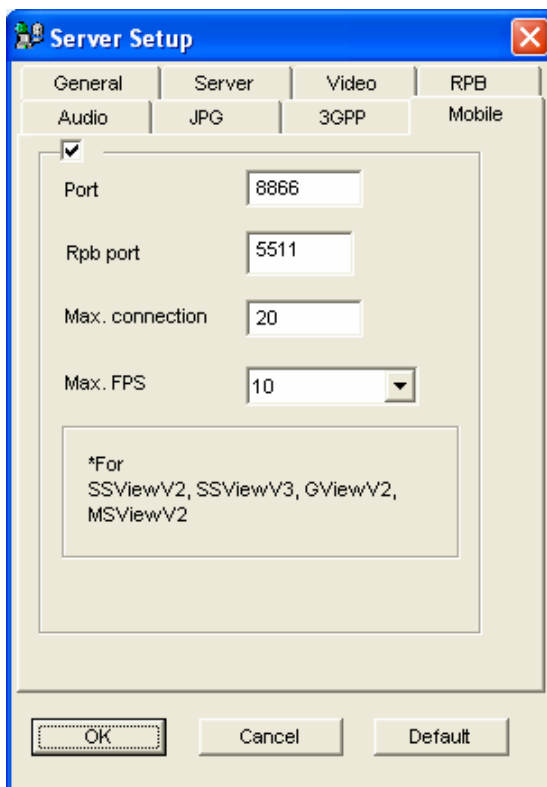

**Figure 6-8**

- **Port:** The default communication port is 8866.
- **Rpb port:** This port is used for remote playback feature. The default value is 5511.
- **Max. connection:** Specify the number of users that can connect to this server. Set the number between 1 and 30.

For the details on the mobile phone applications, see *Remote Viewing with PDA* and *Remote Viewing with Mobile Phone* later in this chapter.

## UPnP Settings

WebCam Server supports UPnP technology (Universal Plug and Play) to allow automatic port configuration to your router.

In order for UPnP to be enabled, the following must be true:

- Windows XP Service Pack 2 is required.
- Windows XP must be configured to use UPnP (see below)
- UPnP must be enabled on your router (consult your router's documentation)

### Enabling UPnP in Windows XP

1. Go to Windows Start, click **Start** button, point to **Settings**, and select **Network Connections**.

This window appears.

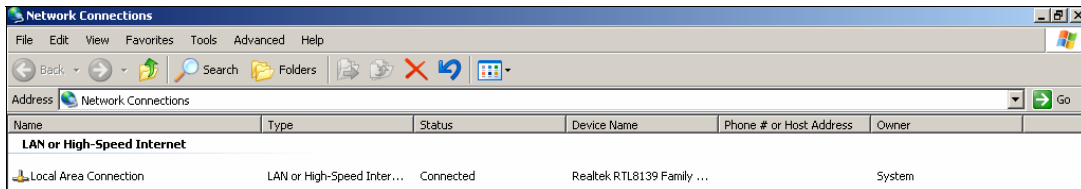

Figure 6-9

2. Right-click one **Local Area Connection**, select **Properties**, and click the **Advanced** tab.

This dialog box appears.

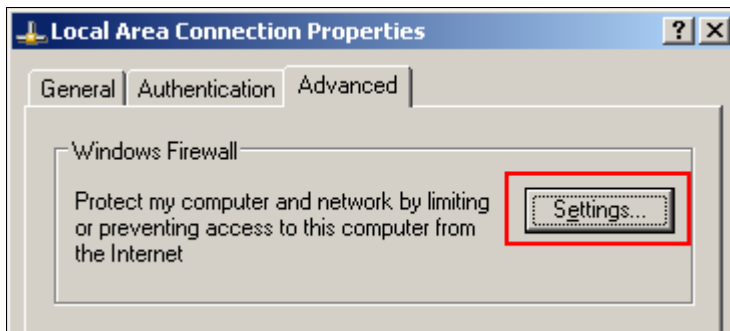
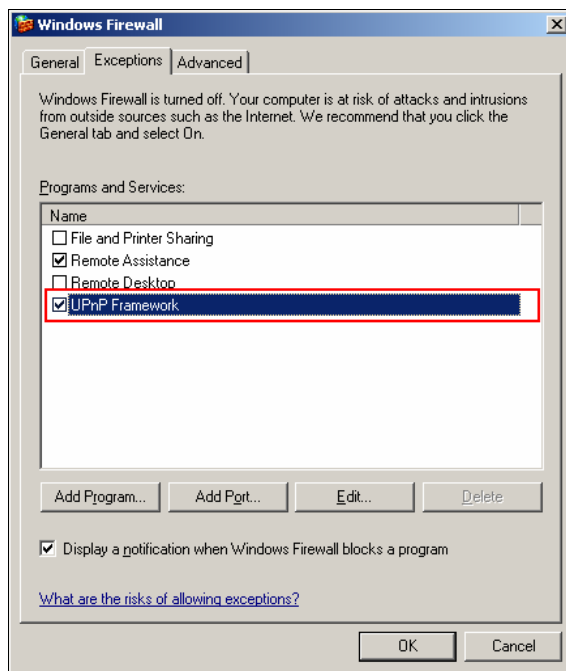

Figure 6-10

3. Click the **Settings** tab, and click **Exceptions** tab. This dialog box appears.

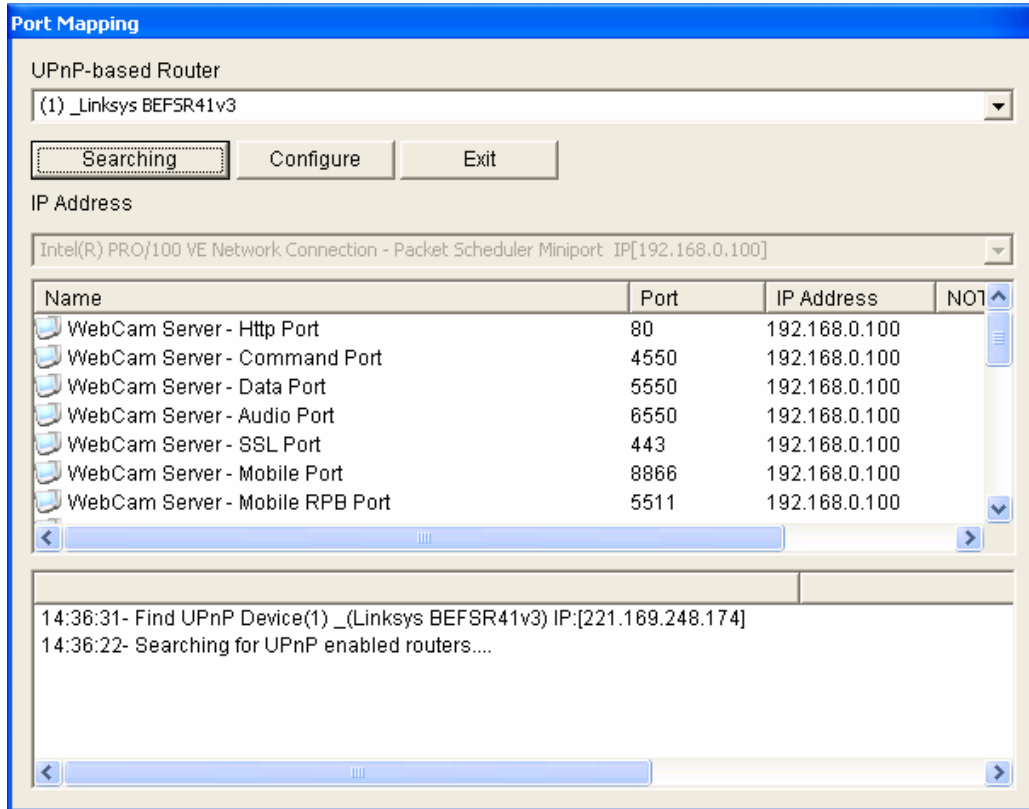

**Figure 6-11**

4. Select **UPnP Framework**, and click **OK**.

## Enabling UPnP in WebCam

1. On the main screen, click the **Network** button, select **WebCam Server**, and click the **Server** tab.  
The Server Setup dialog box (Figure 6-2) appears.
2. Click **Detect UPnP**. This dialog box appears.



**Figure 6-12**

3. Click **Searching** to search the UPnP-enabled routers.
4. If your server is installed with more than one router, select a desired one from the UPnP Router drop-down list.
5. If you server is installed with more than one network adapter, select a desired one from the IP Address drop-down list.
6. Click **Configure** to automatically configure the communication ports on the router.

**Tip:** If you don't use the default ports, modify the related ports in the Server Setup dialog box (Figure 6-2) and then click **OK**. Re-open the dialog box and follow above steps to configure your router.

---

**Note:** UPnP technology now is also available in other remote applications: Control Center, Center V2, Remote Playback, Authentication Server, VSM and TwinDVR.

---



## FTP Server Settings

The option of FTP transfer JPEG file allows you to access the recording files in a folder tree at a client computer installed with the FTP server. In Figure 6-6, select the **FTP transfer JPEG file** option, and then click the **FTP Setup** button to display the following dialog box.

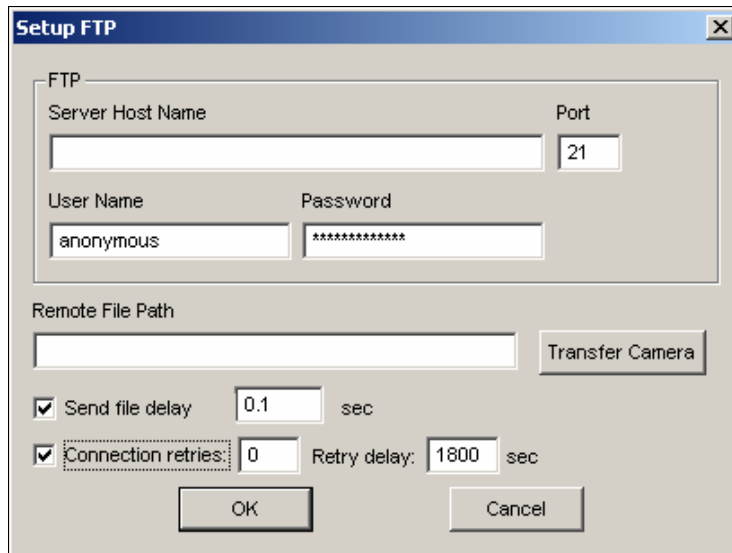

**Figure 6-13** FTP Setup

1. In the Server Host Name field, enter the IP address or domain name of the FTP server. Keep the port setting as default at 21.
2. Enter a valid user name and password to access the FTP server.
3. Specify a file path to save the recording files on the FTP server.
4. Click the **Transfer Camera** button and assign which camera's files to be transferred to the FTP server.
5. In the Send File Delay field, specify the time of updating JPEG files from the GV-System to the FTP server. The time range is from 0.1 to 10 sec.
6. In the Connection Retries field, specify the number of retries when the FTP connection fails (Max: 999). In the Retry Delay field, specify the interval between each retries (Max: 9999 sec.).
7. Click **OK** to apply above settings.

## Network Port Information

The Network Port Information is designed for users to view and manage all network ports of the GV remote applications.

On the main screen, click the **Network** button, and select **Network Port Information**. This dialog box appears.

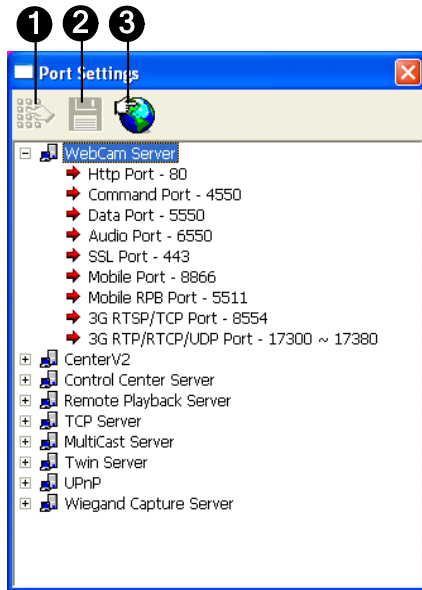

**Figure 6-14**

The controls on the Port Settings:

No.	Name	Description
1	Modify	Changes the port settings.
2	Save	Saves the port settings.
3	Port Mapping	Employs UPnP technology (Universal Plug and Play) to allow automatic port configuration to the router.

## Accessing Live Video Using a Web Browser

Once the WebCam server at the GV-System is enabled, you can use Microsoft Internet Explorer to remotely view and manage the surveillance images.

1. Start your Internet Explorer browser.
2. Type the IP address or the domain name of the GV-System. This dialog box appears.

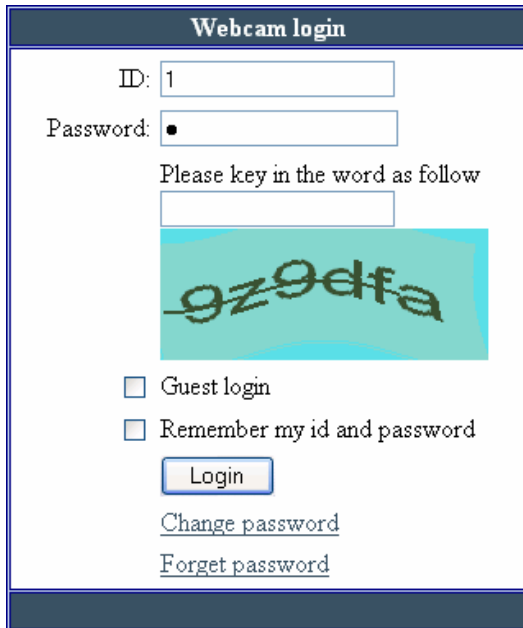

Webcam login

ID: 1

Password: ●

Please key in the word as follow

9z9dfa

Guest login

Remember my id and password

Login

[Change password](#)

[Forget password](#)

**Figure 6-15**

3. Type a user ID and a password created on the GV-System.
4. If the **Enhance network security** option is enabled in the WebCam server (Figure 6-1), you will need to complete the word verification. In this example, type "9z9dfa".

5. Click **Login**. When the connection is established, this Single View page appears.

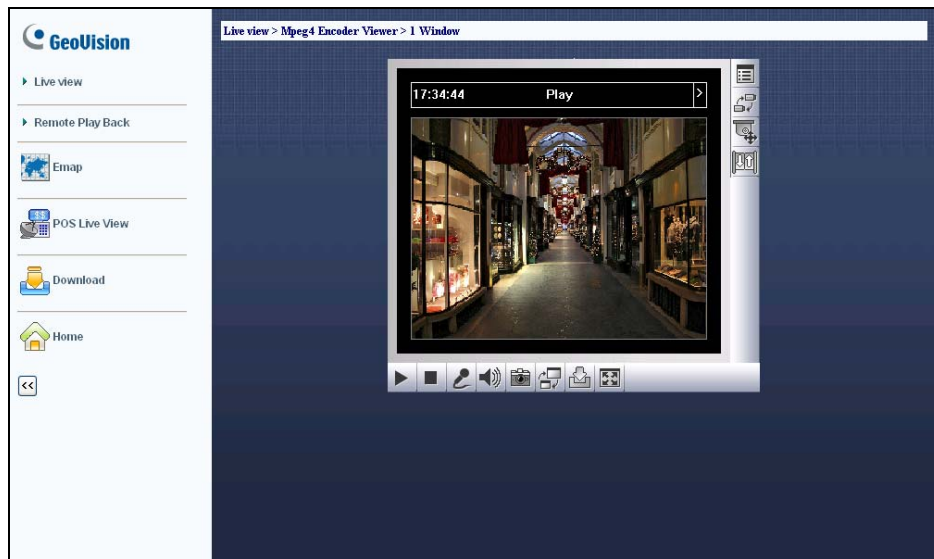

**Figure 6-16**

6. Select one of these WebCam applications at the left panel:
  - **Live View:** Includes three types of MPEG4 encoder viewer: **1 Window**, **2 Windows** and **Multi View**.  
See *Single View MPEG4 Encoder Viewer*, *2-Window MPEG4 Encoder Viewer*, and *Multi View MPEG4 Encoder Viewer* later in this chapter.
  - **Remote Play Back:** Includes three types of remote playback options: **Event List Query**, **Remote Play Back** and **View Log**.  
See *Event List Query*, *Remote Playback on WebCam*, *Remote ViewLog on WebCam* later in this chapter.
  - **E-Map:** Accesses E-Map remotely set up at the GV-System.  
See *E-Map Application* in Chapter 7.
  - **POS Live View:** Monitors the surveillance sites of POS or access control systems.  
See *POS Live View on WebCam* later in this chapter.
  - **Download:** Accesses the Download Center. This function offers optional viewing programs to be downloaded to the local PC.  
See *Download Center* later in this chapter.
  - **Home:** Returns to the Login page.

---

**Note:** When using the applications of MultiView, ViewLog and E-Map for the first time, you will be directed to the Download page. Download and install the desired application before you can run it.

---

## Single View MPEG4 Encoder Viewer



Figure 6-17 Single View MPEG4 Encoder Viewer

The controls in the Single View Viewer:

No.	Name	Description
1	Countdown Timer	Indicates the remaining time when you log in as Guest. When the time is up, you will be logged out automatically.
2	Menu	Includes these options: Information, Video, Audio, Preset Go, I/O Control, Alarm Notify, Camera Adjustment and Download. For details, see <i>Control Panel</i> later in this chapter.
3	Expand / Close	Expands or closes the Menu option list.
4	Option Selection Bar	Selects the Menu option. For the list of options, see "Menu" above.
5	Show System Menu	Brings up these options: Alarm Notify, Video and Audio Configuration, Remote Config, Change Server, Show Camera Name and Image Enhance.
6	Change Camera	Sets the desired camera for display.
7	PTZ Control	Displays the PTZ control panel.
8	I/O Control	Displays the I/O control panel.
9	Full Screen	Switches to full screen view.
10	File Save	Saves live video in the local computer. Use the slide bar to adjust the time length of each saved clip.
11	Change Quality	Adjusts video quality with two options: <b>Geo H264</b> and <b>Geo MPEG4</b> . If the connected site (GV-2004, GV-2008, GV-IP Camera, or GV-Video

		Server) supports hardware compression, the option of <b>IP Camera MPEG2</b> or <b>IP Camera MPEG4</b> appears.
12	Snapshot	Takes a snapshot of the displayed live video.
13	Speaker	Enables live audio from the remote GV-System.
14	Microphone	Enables speaking to the remote GV-System.
15	Stop	Terminates the connection to the remote GV-System.
16	Play	Connects to the remote GV-System.

## Control Panel

A control panel is provided for a direct view and control of the connected channel. To open the control panel, click the **Expand / Close** button (No. 3, Figure 6-17) on top of the Single View viewer. To change the pages of the control panel, click the **Menu** button (No. 2, Figure 6-17). You can also use the **Option Selection Bar** (No.4, Figure 6-17) to change the pages.

The functions on the control panel:

- **Information:** Displays the current version, local time, host time and number of channels currently accessing WebCam.
- **Video:** Displays the current video codec, resolution and data rate.
- **Audio:** Displays audio data rates when the microphone and speaker devices are enabled.
- **Preset Go:** Allows you to remotely move the PTZ to the preset points.
- **I/O Control:** Provides a graphic display of the input and output devices connected to the DVR. For details, see *I/O Control* later in this chapter.
- **Alarm Notify:** Displays the captured images by sensor triggers and/or motion detection. For details, see *Alarm Notify* later in this chapter.
- **Camera Adjustment:** Allows you to remotely adjust image quality by moving the slide bars to the desired values.

- **Download:** Allows you to download the updated programs from the FTP server to the local computer, or install the programs from the hard drive. To download the updated programs from GeoVision FTP server, click **Search**, select **Internet**, and type the following information:

<ftp://gv-update.dipmap.com>

Port: 21

Username: update

Password: update



*Figure 6-18*

## Administrating Host Server

This option allows you to add, edit, and remove a GV Server from the Host drop-down list. The drop-down list is used to switch the connection to a different GV Server listed inside. Click the **Show System Menu** button (No. 5, Figure 6-17), and select **Change Server** to display the following dialog box.

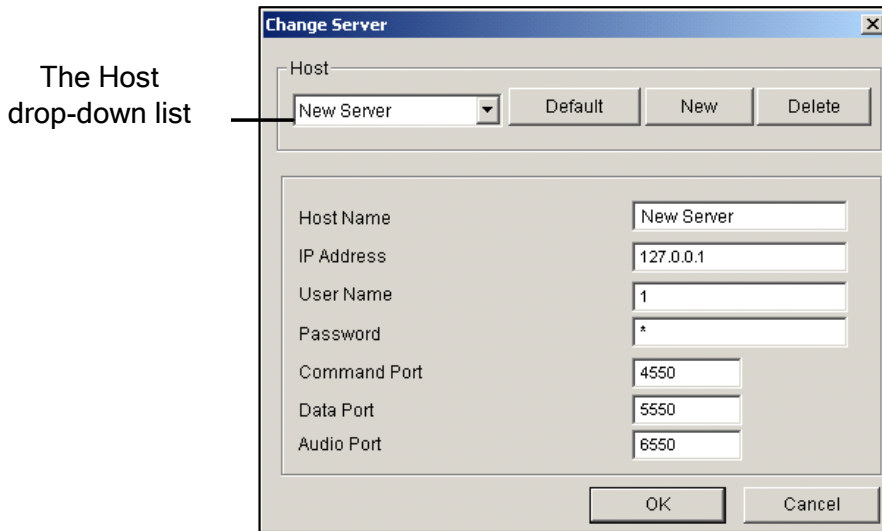

**Figure 6-19** Change Server

**[Adding Host Server]** To add a host server to the drop-down list, click the **New** button. In Host Name field, type a name to identify the designated GV Server. Type the IP address or domain name of the GV Server. Type a valid user name and password with privilege to use this function. Leave all port settings as defaults at **4550**, **5550**, and **6550** respectively unless otherwise necessary. Click the **OK** button. Then the created GV Server will appear in the drop-down list.

**[Editing Host Server]** Select the GV Server you wish to edit from the Host drop-down list. All information of the selected server will be displayed. Change the information in the fields as required and click the **OK** button. Then the information is updated and connection is switched to the edited GV Server.

**[Removing Host Server]** Select the GV Server you wish to remove from the Host drop-down list, and then click the **Delete** button to remove it.



## Taking a Snapshot from a Live Video

Click the **Snapshot** button (No. 12, Figure 6-17) to display the following Snapshot window. Click the **Save** button to save this image in the local PC.

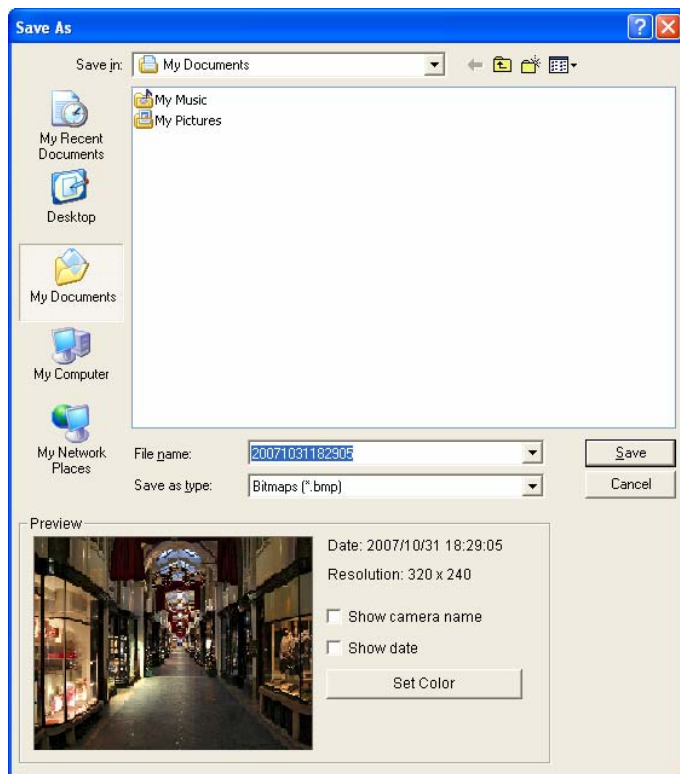

**Figure 6-20**

## Pop-Up Setup

The Single View MPEG4 Encoder Viewer can be set to pop up as soon as motion is detected or I/O devices are triggered. Also up to four captured images will be displayed in the control panel of the Single View. To enable the function, follow these steps.



**Figure 6-21**

1. Click the **Show System Menu** button (No. 5, Figure 6-17), and then select **Alarm Notify**. This dialog box appears.

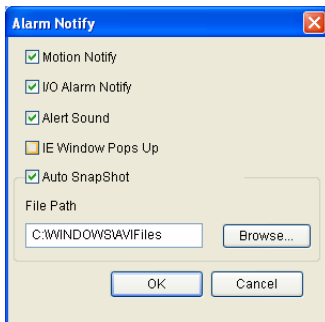

**Figure 6-22 Alarm Notification**

- **Motion Notify:** Once motion is detected, the captured images are displayed in the control panel of the Single View.
  - **I/O Alarm Notify:** Once the input device is triggered, the captured images are displayed in the control panel of the Single View.
  - **Alert Sound:** Activates the computer noise alarm on motion and input-triggered detection.
  - **IE Window Pops Up:** The minimized Single View pops up on motion and input-triggered detection.
  - **Auto Snapshot:** The program will take a snapshot every 5 seconds on motion and input-triggered detection.
  - **File Path:** Assigns a path to save the snapshots.
2. Click **OK** to apply the above settings.
  3. Minimize your browser to test the pop-up function.

## Video and Audio Configuration

To change the video and audio configurations of the connected camera, click the **Show System Menu** button (No. 5, Figure 6-17), and select **Video and Audio Configuration**.

### [Camera]

In this tab, you can change the video codec, quality and frame rate immediately. The Resolution can only be changed when the resolution of the connected GV-System is set to **Middle** or higher. For details, see *[Video]* in *WebCam Server Settings* earlier in this chapter. Note the Defog and Stabilizer options are only available after they are enabled at the connected GV-System.

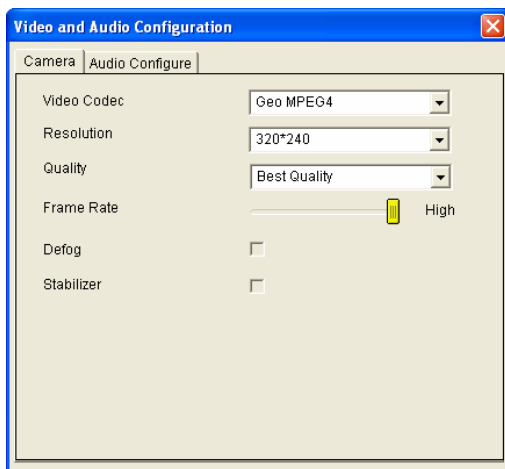

Figure 6-23

### [Audio Configure]

In this tab, you can enable the microphone and speaker for two-way audio communication and adjust the audio volume. For this function to work, make sure the hardware and software are properly set up and installed. For details, see *[Audio]* in *WebCam Server Settings* earlier in this chapter.

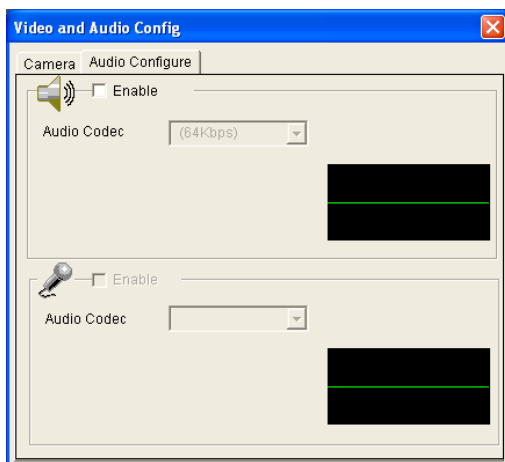

Figure 6-24

## Exporting Video

Click the **File Save** button (No. 10, Figure 6-17) to save video in a local PC. Files saved in AVI format are playable at third party viewers.

## PTZ Control

Click the **Camera Select** button to select one PTZ camera, and then click the **PTZ Control** button (No. 7, Figure 6-17) to bring up the PTZ control panel.



**Figure 6-25** PTZ control panel

One PTZ camera only allows one user to control at a time. If several users are trying to control the same PTZ camera at the same time, the Single View viewer will give the priority to the first login user and then to the next user in queue. Each user will be given 60 seconds to control the PTZ camera. The Timer at the upper right corner informs the user of the remaining time of control or the total waiting time.

The supervisor is given the highest priority to control the PTZ camera and won't be restrained by 60-second time limit. When the supervisor logs in WebCam, the Timer shows 999.

The **PTZ Speed** button in the lower part allows you to configure the speed of a PTZ camera up to five levels.

## I/O Control

The new interface provides real-time graphic displays of camera and I/O status, and alarm event. Additionally, you can force output, as well as enable and disable I/O devices to the remote GV-System. Click the **I/O Control** button (No. 8, Figure 6-17) to bring out the I/O control panel.

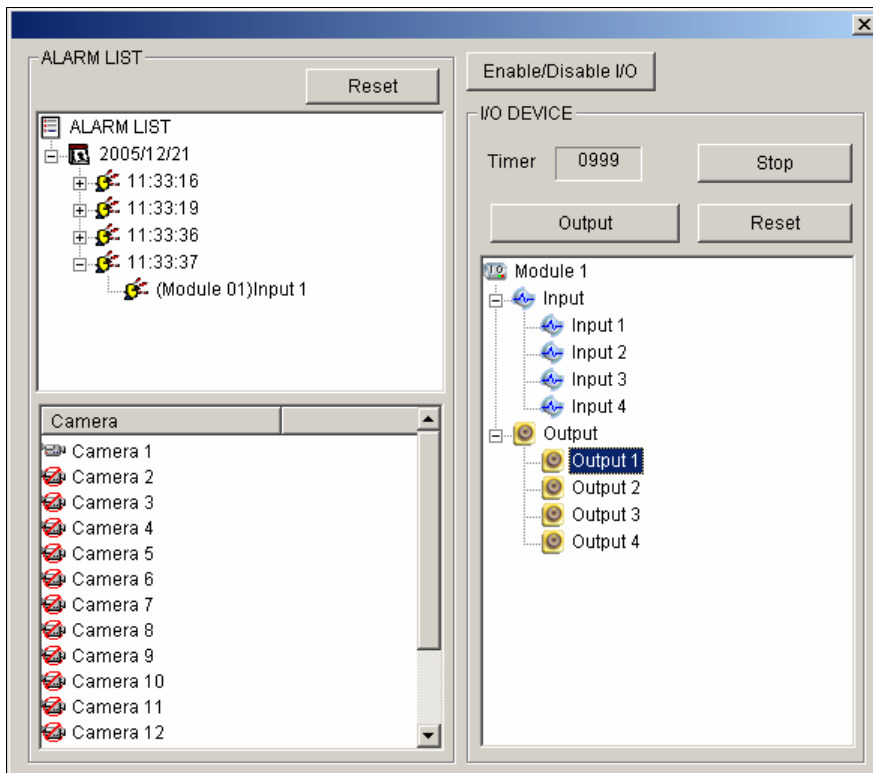

**Figure 6-26** I/O Control

The alarm status is displayed in three levels. The first level indicates date, second indicates time, and the third indicates alarm ID. Clicking the **Reset** button will clear the alarm list.

To initiate an output device, click the **Enable** button, highlight an output and then click the **Output** button. The Timer functions the same as in the PTZ control panel. Each user will be given 60 seconds of control time while the supervisor has 999 seconds. Clicking the **Stop** button will stop the operation and turn over the control privilege to the next user waiting online.

If you want to enable or disable I/O devices to the remote GV-System, click the **Enable/Disable I/O** button. For this, the remote GV-System must grant the privilege first. Enable the **Enable Remote Control** option in Figure 6-1.

## Visual Automation

You can remotely change the current status of the electronic device by simply clicking on its image. Moreover, you can manage the settings of Visual Automation.

This feature is only available when the Visual Automation is configured ahead on the GV-System.

- To access this feature, click the **I/O Control** button (No. 8, Figure 6-17), and select **Visual Automation**.
- Right-click the green **I/O** icon on the left corner to manage the alert areas, such as displaying, embossing and changing colors to alert areas.
- Click the alert areas on the image to force the outputs to be triggered remotely.



**Figure 6-27**

## Visual PTZ

Other than the PTZ control panel, you can display a Visual PTZ Control Panel on the image.

To access this feature, click the **PTZ Control** button and select **Visual PTZ**. For details on using the Visual PTZ Control Panel, see *PTZ Automation* in Chapter 1.

## Display of Video Resolution

To view the current video resolution, right-click the screen, and select **Resolution**. The video resolution indicator appears at the bottom of the right corner of the screen. When the resolution is changed, the indicator also changes simultaneously.

## Picture-in-Picture View

With the Picture in Picture (PIP) view, you can crop the video to get a close-up view or zoom in on the video. This function is useful for megapixel resolution that provides clear and detailed images of the surveillance area.

To access this feature, click the **Full Screen** button, right-click on the screen and then select **PIP**. For details on usage, see *Picture-in-Picture View* in Chapter 1.

## Picture-and-Picture View

With the Picture and Picture (PAP) view, you can create a split video effect with multiple close-up views on the image. A total of 7 close-up views can be defined. This function is useful for megapixel resolution that provides clear and detailed images of the surveillance area.

To access this feature, click the **Full Screen** button, right-click on the screen and then select **PAP**. For details on usage, see *Picture-and-Picture View* in Chapter 1.

## Image Enhancement

To enhance the image quality of live video, click the **Show System Menu** button (No. 5, Figure 6-17) and select **Image Enhance**. This dialog box appears.

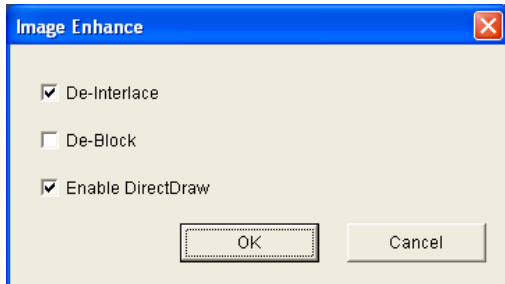

**Figure 6-28**

- **De-Interlace:** Converts the interlaced video into non-interlaced video.
- **De-Block:** Removes the block-like artifacts from low-quality and highly compressed video.
- **Enable DirectDraw:** The DirectDraw setting is enabled by default. Some VGA cards might not support DirectDraw and can produce distorted frames. Uncheck this option to disable the DirectDraw function.

## Remote Configuration

Remote Configuration allows you to adjust video images, start/stop recording, enable/disable I/O monitoring and activate/deactivate schedules to the remote GV-System. For this, the remote GV-System must grant the privilege first. See the **Enable Remote Control** option in Figure 6-1.

Click the **Show System Menu** button (No. 5, Figure 6-17) and select **Remote Config** to display the following dialog box.



**[Record]**

Check the desired cameras to start or stop recording to the remote GV-System.

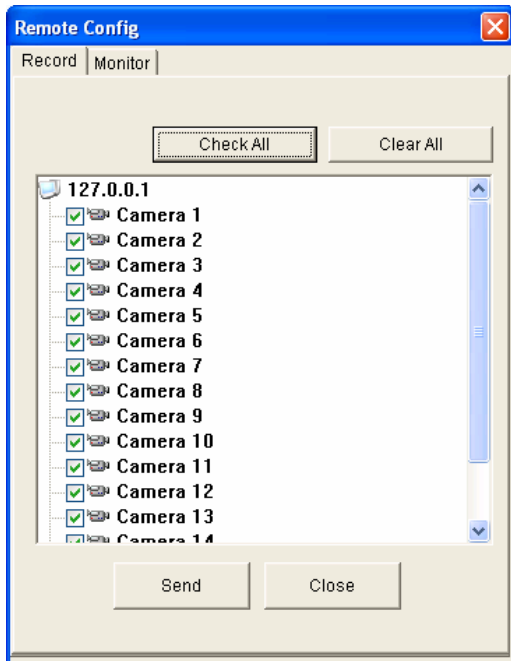

*Figure 6-29*

**[Monitor]**

Enable I/O and Schedule monitoring to the remote GV-System. Click the **Send** button to apply the settings.

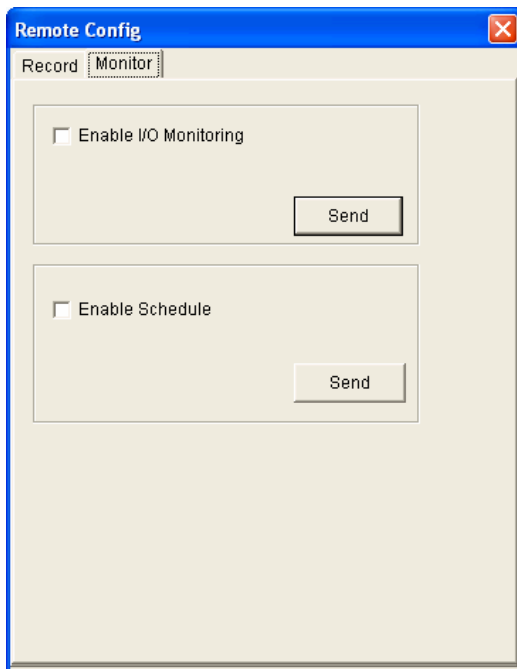

*Figure 6-30*

## 2-Window MPEG4 Encoder Viewer

On the 2 Windows, you can drag and drop the **camera**, **PTZ** and **I/O** icons to the desired window for the following functions respectively:

- video display
- activating the Visual PTZ Control Panel on the image
- activating the Visual Automation function

To access the 2 Windows, click **Live View** on the left panel of the Single View page, and then select **2 Windows**.



*Figure 6-31*

## Multi View MPEG4 Encoder Viewer

Multi View is a multi-channel MPEG4 Encoder Viewer, allowing users to view 4, 8, and 16 live cameras simultaneously. Because multiple channels require a large amount of data to be transferred over Internet, this function is limited to broadband users only.

### Starting Multi View

You can install the MultiView over the Internet or from the Surveillance System Software CD. The following is an example of installing and running the MultiView over the Internet.

1. Follow the instructions of *Accessing Live Video Using a Web Browser* earlier in this chapter until the Single View page (Figure 6-16) appears.
2. Click **Live View**, select **MultiView** and then select the desired resolution. The first-time user will be directed to the Download page and it is required to download the MultiView program before you can run it. For details, see *Download Center* later in this chapter.
3. To log in the MultiView, enter a valid user ID and password. The MultiView window appears.



Figure 6-32 The Multi View Window

The controls in the Multi View:

No.	Name	Description
1	Monitoring Window	Displays live video.
2	Host Server	Displays connected GV-Systems and their available cameras.
3	UPnP Device	Displays all hosts on the same LAN.
4	PTZ Control	Displays the PTZ control panel.
5	I/O Control	Displays the I/O control panel.
6	Channel Status	Indicates the general information of the selected channel.
7	ViewLog	Plays back recorded files of the remote GV-System by using the video player ViewLog.
8	Configure	Accesses system settings of the Multi View.
9	Edit Host	Adds, deletes or modifies GV-Systems.
10	Camera Status	Displays the camera status of the connected GV-Systems.
11	Host Information	Displays the general information of the connected GV-Systems.
12	Zoom in and out	Zooms in or out the selected channel.
13	Add/Remove Channel	Adds or deletes the channels for video polling. Click the <b>Add or Remove Channel</b> button and then click the desired channel to add to or remove from the video polling.
14	Full Screen	Switches to a full screen view.
15	Video Polling	Rotates through the selected channels.
16	Screen Divisions	Sets screen divisions to 4, 8 or 16.
17	Exit/Minimize	Closes or minimizes the Multi View window.
18	Speaker	Enables live audio from a remote GV-System.
19	Microphone	Enables speaking to a remote GV-System.
20	Play	Establishes the connection to a GV-System.
21	Stop	Terminates the connection to a GV-System.
22	Save	Saves live video.
23	Quality	Changes video resolution.
24	Snapshot	Takes a snapshot of the selected channel.
25	Save Camera to Multiple Host	Saves the selected cameras and to create a Multiple Host.

## Working With the Host Server Window

The Host Server window displays a list of available GV Servers. The server icons indicate available servers and the camera icons indicate all cameras included in the selected server. To connect to a server site:

1. Click a monitoring window, which will be highlighted in red frame.
2. Double-click on a camera icon, and then its corresponding video will be loaded to the selected monitoring window.

First time users will only see one server icon as no additional servers are created yet. For the details of adding new servers to the Host Server window, refer to *Creating a Quick Connection to a Host Server*, later in this chapter.

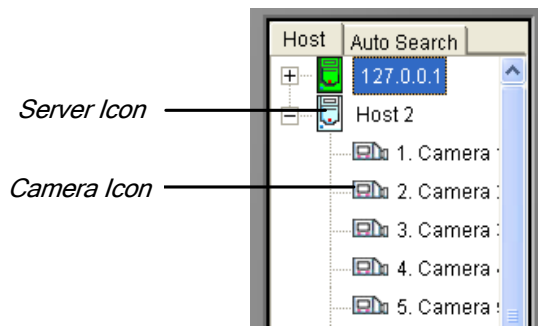

**Figure 6-33** The Host Server Window

## Working with Hosts on the Same LAN

With UPnP technology, MultiView can detect all hosts on the same LAN, without the need of user configuration.

1. On the Host window, click the **UPnP Device** tab for detection. The blue icon means WebCam Server is activated at the host while the white icon means WebCam Server is not enabled
2. Double-click one host for connection. A valid ID and password are required.

---

**Note:** For UPnP detection, the host needs to open TCP port 5201 and the MultiView site needs to open UDP port 5200.

---

## Exporting Video

You can save live videos in a client computer. The files in AVI format are playable at the third party viewer. Click the **Save** button (No.22, Figure 6-32) and then select all or several cameras to start recording. For the folder path, see Figure 6-38.

## Taking a Snapshot from a Live Video

Click a desired channel, and then click the **Snapshot** button (No.24, Figure 6-32) to take a snapshot of live video.

## PTZ Control

1. Select a PTZ capable camera from the monitoring window, or double-click it on the Host Server window.
2. Click the **PTZ Control** button (No. 4, Figure 6-32).
3. Turn the switch to the **ON** position.
4. Use the directional, zoom-in, zoom-out, focus-in, focus-out buttons to control the PTZ camera.

The Timer has the same functions as the one in the Single View MPEG4 Encoder Viewer. The supervisor is given the highest priority to control PTZ in Multi View and won't be restrained by 60-second time limit. When the supervisor logs in Multi View, the Timer will show 999.

The **Option** button lets you direct the PTZ camera to a preset position and configure the speed of the PTZ camera up to five levels.

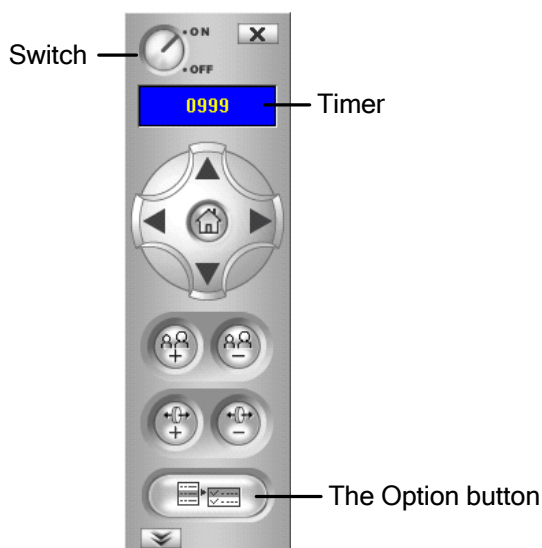

**Figure 6-34** PTZ control panel

## Output Control

1. Click the **I/O Control** button (No. 5, Figure 6-32).
2. Turn the switch to ON position.
3. Select a module from the drop-down list. Each module provides 4 to 16 connected relay output devices.
4. Click the **Output (x)** button to enable the output device.

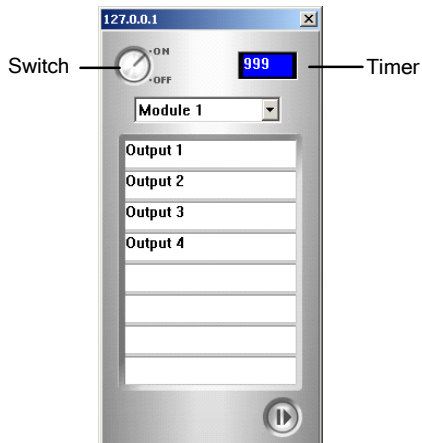

**Figure 6-35** I/O Control Panel

## Channel Status Information

When choosing a camera from the Host Server window or the monitoring window, the general information of the selected camera will be displayed in the Channel Status Window as shown below.

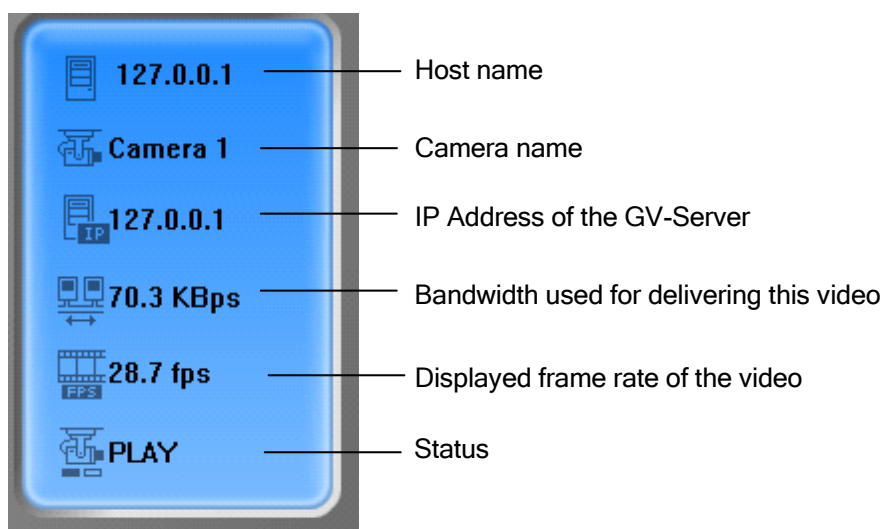

**Figure 6-36** The Channel Status window

## Camera Polling Function

To add cameras to the polling group:

1. Click the **Add Channel** button (No. 13, Figure 6-32), and then click the monitoring windows. The selected windows will be framed in red color.
2. Click the **Video Polling** button (No. 15, Figure 6-32). The application will rotate the selected cameras in the specified time. To configure the polling time, see Figure 6-37.

To remove one camera from the polling group, click the **Remove Channel** button (No. 13, Figure 6-32), and then click its monitoring window.

## Two-Way Audio

The two-way audio in Multi View functions similarly to the one in Single View MPEG4 Encoder Viewer. See *Two-Way Audio* earlier in this chapter for further details.

## Display of Video Resolution

To view the current video resolution, right-click the screen, and select **Resolution**. The video resolution indicator appears at the bottom of the right corner of the screen. When the resolution is changed, the indicator also changes simultaneously.



## Multi View Configuration

Click the **Configure** button (No. 8, Figure 6-32) to display the following window.

The screenshot shows the 'Configure' window with the following settings:

- Startup:** Initial Screen: 16 Division (Default)
- Video Polling:** Polling time: 30 Sec (Default)
- Server Status:** Server Status Refresh Time: Never Minute (Default)
- Camera Status:** Camera Status Refresh Time: Never Minute (Default)
- Save:** Folder Path: E:\456 (Browse) Max Video Clip: 30 Minute (Default)
- Caption:**
  - No
  - ID
  - Name
  - ID+Name
- Enable DirectDraw:**
  - Enable DirectDraw
  - Enable De-Block
  - Enable De-Interlace
- Auto Search Port Setting:**
  - TCP/IP: 5201
  - Multicast: 5200
  - Video Server: 15001
- Full Screen Quality:** Best Quality
- Fast Key:** View
- Audio:** Fast
- Buttons:** OK

**Figure 6-37** The Configure Window

- **Initial Screen:** Select screen divisions at startup.
- **Polling Time:** Specify the camera polling time from 1 to 60 seconds.
- **Server Status Refresh Time:** Specify the refresh time to update the host information.
- **Camera Status Refresh Time:** Specify the refresh time to update the camera information.
- **Folder Path:** Specify a path to save recorded files.
- **Max Video Clip:** Specify the maximum time length of each recorded file to be 3 or 5 minutes. The default time length is 3 minutes.
- **Caption:** Select what kind of caption to display on the monitoring window.  
**ID:** camera ID; **Name:** camera name; **No:** no display.
- **Enable DirectDraw:** The DirectDraw is enabled by default. Some VGA cards might not support DirectDraw and can produce distorted frames. In this case, disable this function.
- **Fast Key:** Click the **View** button to display the fast key table of the Multi View. Refer to *Fast Key Reference* later in this chapter.

## Creating a Quick Connection to a Host Server

To create a quick connection to a new host server, click the **Edit Host** button (No. 9, Figure 6-32). This displays the following window.

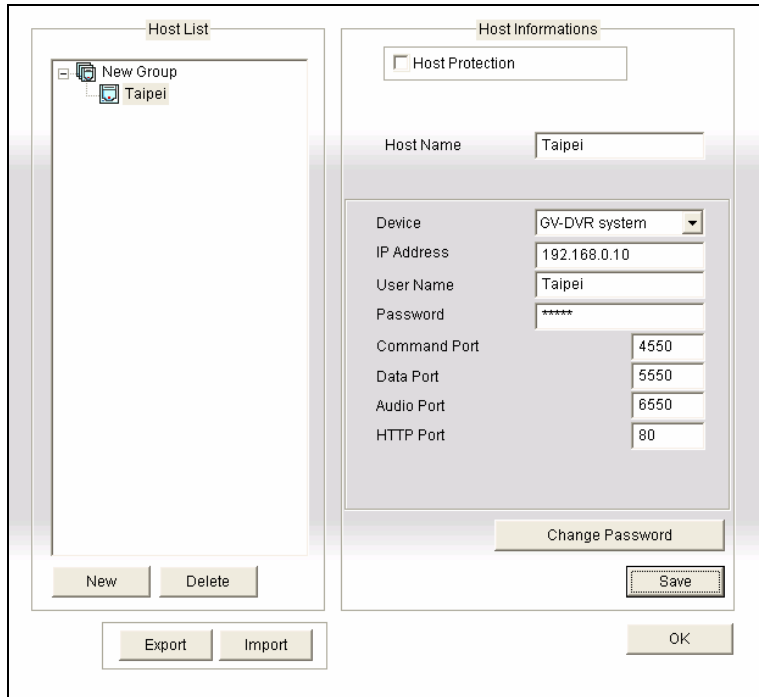

**Figure 6-38** The Edit Host Window

**[Host List]** When a host server is created, it will appear in the Host List section at the left side. Each server can be identified by its given host name. Clicking on the host name and its information will be displayed in the Host Information section.

**[Adding Host Server]** All created host servers are forced to be grouped. Click the **New** button and select **Group** to create a group first. Then click the **New** button again and select **Host** to create a host. In the Host Name field, type a name to identify the designated GV Server. Select a device type for the connected GV Server. Type the IP address or domain name of the GV Server. Type a valid user name and passwords with privilege to use this function. Modify the default ports if necessary to match the corresponding ports on the connected device. Click the **Save** button, and then the GV Server will appear in the Host List section with the given ID name.

**[Editing Host Server]** Select the GV Server you wish to edit in the Host List section. All information of the selected server will be displayed in the Host Information section. Change the information as required and click the **Save** button.

**[Removing Host Server]** Select the GV Server you wish to remove from the Host List section, and click the **Delete** button.

## Creating Multiple Hosts

You can create Multiple Hosts including the camera channels all from different IP addresses. There are two methods to create Multiple Hosts: the manual creation of Multiple Hosts; the quick creation of Multiple Hosts.

### Manual Creation of Multiple Hosts

1. Click the **Edit Host** button (No. 9, Figure 6-32) to display the Edit Host window. Click the **New** button and select **Group** to create a group first. Then click the **New** button again and select **Host** to create a host.
2. Select **Multiple Host** to display the following window.

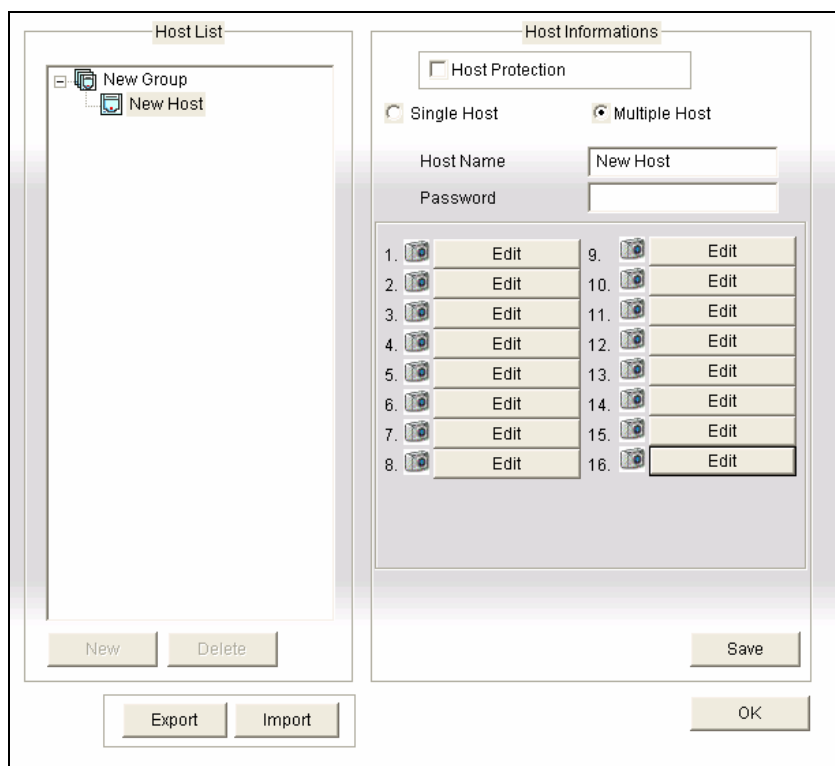

**Figure 6-39** Creating Multiple Hosts

3. In the Host Name field, enter a desired name to identify the Multiple Hosts.
4. To set up each camera channel of the Multiple Hosts, click the **Edit** tab one at a time.
5. Alternatively, you can click and drag the created camera channel from the Host Server window (Figure 6-33) to each **Edit** tab. Note that all created camera channels must be added to each Edit tab in the order of 1 to 16.

- When you click the **Edit** tab, you will see the following window.

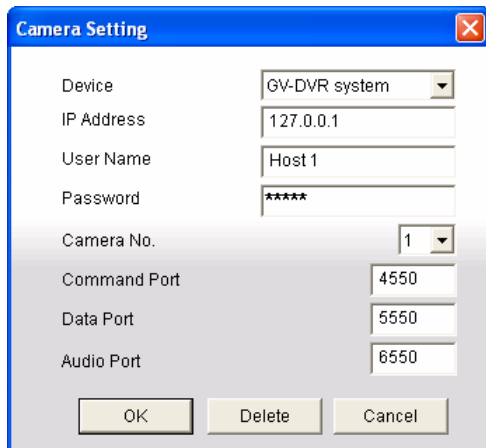

*Figure 6-40 Camera Setting*

- The supported devices include **GV-DVR System**, **GV-Video Server**, **GV-IP Camera** and **Compact DVR**. Use the drop-down list to select the device type of the connected camera.
- Enter the IP address, user name and password of a remote host.
- In the Camera No. drop-down list, select one desired camera channel from the remote host.
- Let the port settings match those of the remote host, or keep them as defaults
- Click **OK**.

The icon of the created Multiple Hosts in the Host Server window is yellow, while others are blue.

### **Quick Creation of Multiple Hosts**

- Click on a desired monitoring window, which will be highlighted in the red frame.
- Click and drag a camera from the Host Server window to the monitoring window. The selected camera then is displayed.
- Repeat the step 1 and 2 to configure other monitoring windows for different cameras.
- Click the **Save Camera to Multiple Host** button (No. 25, Figure 6-32) to create the Multiple Hosts.

## Camera Status

To show the camera status of the selected GV Server, click the **Camera Status** button to display the following window. “Camera ON” indicates the camera is active. “No Privilege” means you’re not authorized to view this camera. Clicking the **View** button will bring up a small window displaying the selected camera’s video. Clicking the **Refresh** button will refresh the information in this window.

The screenshot shows a software window titled "Camera Status". At the top, there is a "Host Informations" section with three input fields: "Host Name" containing "2.dipmap.com", "IP Address" containing "2.dipmap.com", and "User Name" containing "1". Below this is the "Camera Status" section, which features a "Refresh" button in the top right corner. The main area contains a table with 16 rows, each representing a camera. Each row includes a camera icon, the camera name (Camera 1 through Camera 16), its status (all are "Camera ON"), and a "View" button. At the bottom right of the window is an "OK" button.

Camera	Status	Action
Camera 1	Camera ON	View
Camera 2	Camera ON	View
Camera 3	Camera ON	View
Camera 4	Camera ON	View
Camera 5	Camera ON	View
Camera 6	Camera ON	View
Camera 7	Camera ON	View
Camera 8	Camera ON	View
Camera 9	Camera ON	View
Camera 10	Camera ON	View
Camera 11	Camera ON	View
Camera 12	Camera ON	View
Camera 13	Camera ON	View
Camera 14	Camera ON	View
Camera 15	Camera ON	View
Camera 16	Camera ON	View

**Figure 6-41** The Camera Status Window

## Host Information

Click the **Host Information** button (No.11 Figure 6-32) to display the following window. The Host Information window contains the following three categories. Use the control tabs to toggle among them.

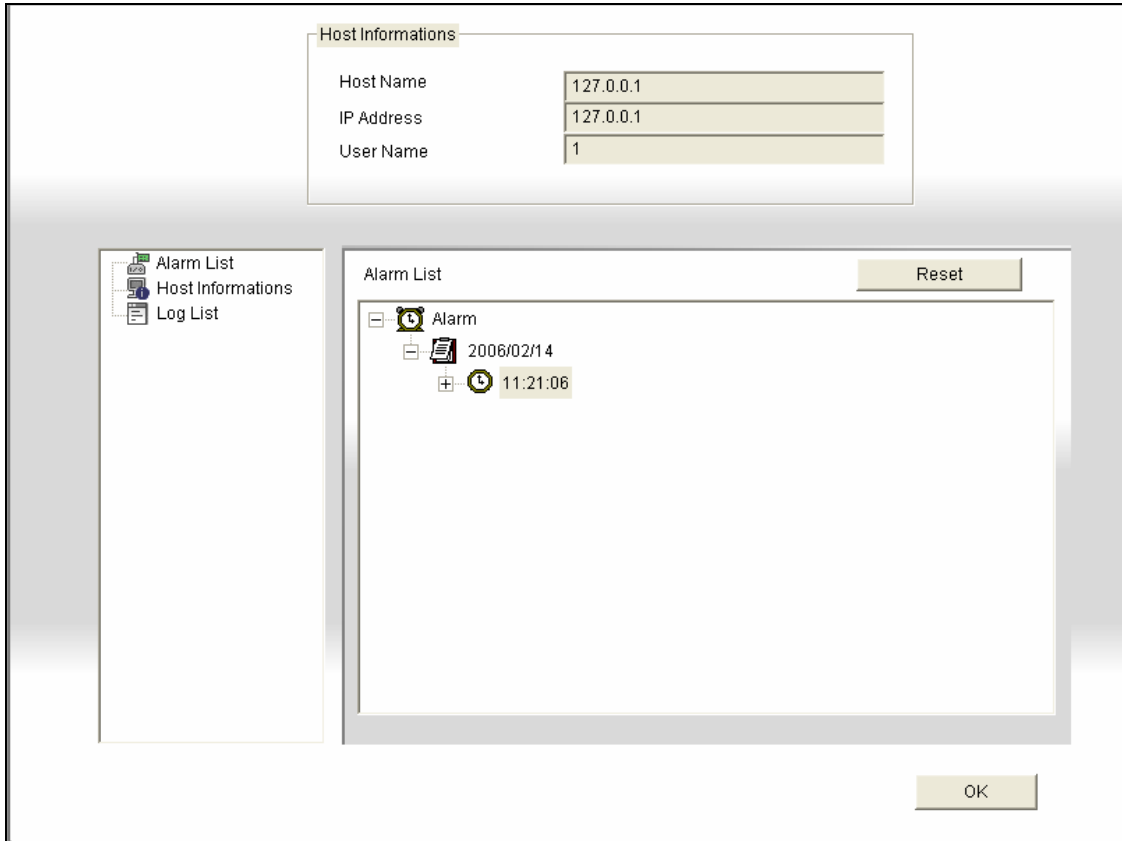

**Figure 6-42** The Host Information Window

**[Alarm List]** Displays a list of alarm events occurred in the selected **GV Server**. Clicking the **Reset** button will clear the listed events. New events will be generated until the alarms of the local site are invoked.

**[Host Information]** The upper section shows the general information of the connected **GV Server**. The lower section shows the number of MPEG4, RPB, and audio channels currently serving over the Internet.

**[Log List]** Displays a history of login and logout information.

## Remote ViewLog

More than simply playing back recorded video/audio files, the Remote ViewLog function allows you to have full access to the ViewLog features of the connected GV-System.

---

**Note:** To use the Remote ViewLog for the first time, you need to install the Remote ViewLog components on the local PC. Install the components from the Surveillance System Software CD, or from the Download page (see *Download Center* later in this chapter).

---

1. On the MultiView window, click the **ViewLog** button (No. 7, Figure 6-32). The Connect to Remote ViewLog Service dialog box appears.
2. Type the IP Address, ID and Password of the remote GV-System. Keep the default port as **5552**, or modify it if necessary.
3. In the Host Type field, select **DVR**.
4. Click the **Connect** button.

When the connection is established, you will see the video player ViewLog appears on the screen. Then you can access all ViewLog features for playback

## JPEG Image Viewer

JPEG Image Viewer is a cross-platform viewer, practicable on Mac OS, Netscape, and Microsoft IE browsers. Continuously receiving JPEG images from GV-System and limited to the single camera view, the viewer is an ideal tool for the users with limited Internet bandwidth.

To start the JPEG Image Viewer, follow these steps:

1. To enable the function on the WebCam server, click the **Network** button, select **WebCam Server**, disable **Enhance Network Security** in the General tab (Figure 6-1), and enable **Create JPEG/GIF File(s)** in the JPG tab (Figure 6-6).
2. Open an Internet browser in the local PC.
3. Enter the IP address or domain name of the GV-System. The Single View page (Figure 6-16) appears.
4. On the left panel, click **Live View** and select **JPEG Image Viewer**. A valid ID and password are required for login. The JPEG Image Viewer window appears.



**Figure 6-43** JPGE Image Viewer



## Remote Playback on WebCam

The WebCam Remote Playback (RPB) is a web-based application, allowing you to play back recorded video or audio files of the connected GV-System.

To start WebCam RPB:

1. Follow the steps in *Starting WebCam at the Local PC* earlier in this chapter until the Single View page (Figure 6-16) appears.
2. On the left panel, click **Remote Play Back**, and select **Remote Playback**. This RPB window (Figure 6-44) appears.
3. Click the **Play** button (No. 10, Figure 6-44) to log in the application. A valid ID and password are required here.



**Figure 6-44** The Remote Playback Window

The controls in the Remote Playback on WebCam:

No.	Name	Description
1	File Tree	Displays date folders.
2	Event List	Displays the video events
3	Channel Select	Selects different channels.
4	Option	Includes the Enable DirectDraw option.
5	Object Search	Searches Object Index.

6	Get Event List	Displays the Event List.
7	Smart Search	Includes the Advanced Search option.
8	Audio	Enables live audio from the remote GV-System.
9	Pause	Pauses the video file.
10	Play	Plays the video file.
11	Stop	Stops the video file.
12	Download	Downloads the video file.
13	Snapshot	Takes a snapshot of the displayed live video.
14	Full Screen	Switches to a full screen view.

## Searching and Playing Back Recorded Files

The WebCam RPB allows you to play back video and audio files. Audio files are only available when your system is equipped with the optional audio recording function.

1. Click the **Get Event List** button (No. 6, Figure 6-44) and then select **Get Date List**. This loads the recorded data from the **GV-System**.
2. Select a date in the File Tree.
3. All video files recorded within the selected date range will be listed in the following Event List window.

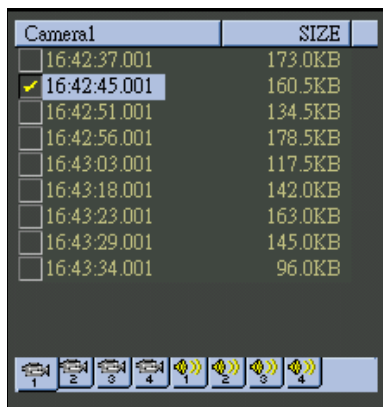

**Figure 6-45** Event List

4. Select one camera or audio channel from the **Channel Select** buttons (No.3, Figure 6-44).
5. Select one video file from the Event List, and then click the **Play** button (No.10, Figure 6-44) to play it.

## Synchronizing Audio with Video Playback

To synchronize audio with video playback, click the **Get Data List** button and then select **Enable Audio**.

## DirectDraw Setup

The DirectDraw setting is enabled by default. Some VGA cards might not support DirectDraw and can produce distorted frames. In this case, disable the function from the **Option** button (No.4, Figure 6-44).

## Searching Object Index

You can locate and play back the Object Index files through the WebCam RPB. For the details on Object Index, see *Retrieving Images Using Object Index* in Chapter 1.

1. Click the **Object Search** button (No. 5, Figure 6-44), and then select **Search Object Index**. This window appears.

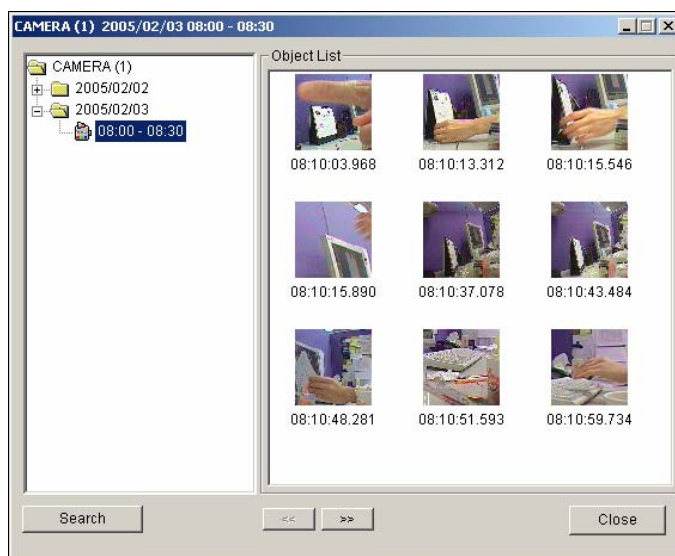
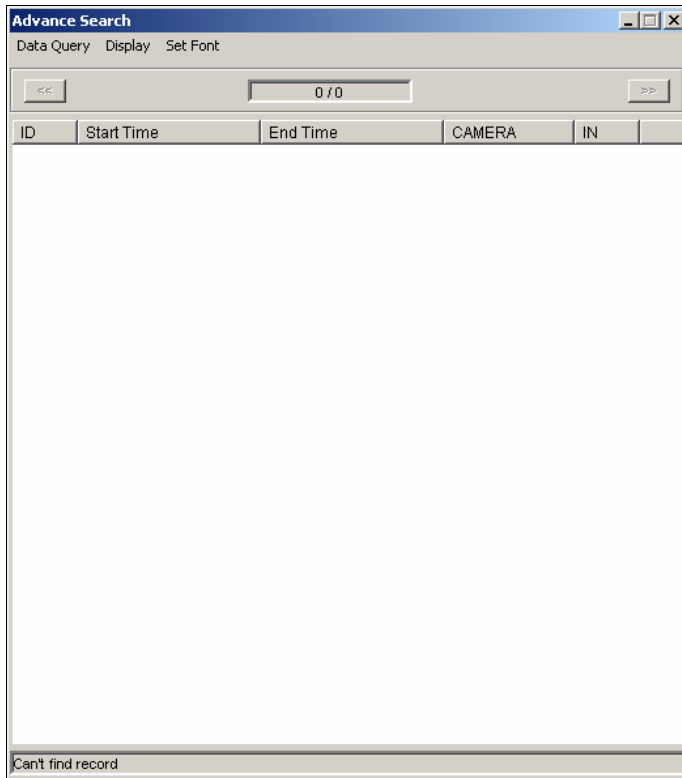

**Figure 6-46** The Search Object Index Window

2. Click the **Search** button. The Search window appears.
3. Select the desired cameras, and then click **Search**. The found files will be displayed on the left side of the Search Object Index window.
4. Expand the files to access the thumbnail view.
5. Double-click one displayed image. The related video will play on the RPB.

## Advanced Search

The advanced search function in the WebCam RPB lets you easily locate an event by search criteria. The search results can be displayed in a text form and/or a statistic chart. Click the **Smart Search** button (No. 7, Figure 6-44), and select **Advance Search** to open the following advanced search window.



**Figure 6-47** Advanced Search

**[Display]** This option on the menu bar lets you choose which way to display search results: a text form or a statistic chart.

**[Data Query]** To locate an event, click **Data Query** on the menu bar. The selections included inside are: (1) Monitor, (2) System, (3) Login, (4) Counter and (5) POS. The five categories are based on those of System Log in the Main System (see *System Log* in Chapter 1), so that you can locate any event type recorded in System Log.

- Monitor/System/Login/Counter:** The four selections let you locate an event about monitoring, system, login/logout and counter status. The dialog boxes of the four selections are similar, so we take Monitor as an example below.

Click **Data Query** on the menu bar, and select **Monitor** to display the following window. Define your search condition in each field, and click **OK** to start searching.

The 'System' dialog box contains the following fields and controls:

- Event Type:** A dropdown menu with 'Motion' selected.
- Device:** A dropdown menu with 'Camera 1' selected.
- Module:** A dropdown menu with 'Module 1' selected.
- Date:** A date picker showing '2004/08/04'.
- Time:** Two time pickers showing '00:00:00' and '19:07:05' with a tilde (~) between them.
- Buttons:** 'OK' and 'Cancel' buttons at the bottom right.

**Figure 6-48** Locating a system event

- **POS:** The selection lets you locate a desired POS transaction event. Click **Data Query** on the menu bar and select POS to display the following window.

The 'POS' dialog box contains the following fields and controls:

- Date:** A date picker showing '2001/02/20'.
- Time:** Two time pickers showing '00:00:00' and '16:49:28' with a tilde (~) between them.
- Event Type:** A dropdown menu with 'All' selected.
- Device:** A dropdown menu with 'POS 1' selected.
- Condition 1:** A checked checkbox, a dropdown menu with 'Coke', an equals sign (=) operator, and an empty text box.
- Condition 2:** A checked checkbox, a dropdown menu with 'Coke', an equals sign (=) operator, and an empty text box.
- Condition 3:** A checked checkbox, a dropdown menu with 'Coke', an equals sign (=) operator, and an empty text box.
- Statistic:** A checked checkbox, a dropdown menu with 'Coke', and two radio buttons: 'Sum' (selected) and 'Average'.
- Buttons:** 'OK' and 'Cancel' buttons at the bottom right.

**Figure 6-49** Locating a POS event

Restrict your search to a certain date, time, event type, POS system, transaction item (content), and price amount (value). Then click **OK** to start searching. For this example, we like to search all the transaction types related to Coke, registered in the device POS 4, from 00:00:00 to 13:43:19 on 2004/07/13. Its price amount may be *greater than or equal to* ( $\geq$ ) 1 and *less than or equal to* ( $\leq$ ) 99. If we select the **Statistic** option and click **OK** here, we will get the sum or the average price of all the discovered transaction events, not a list of these events.

## Remote ViewLog on WebCam

Through WebCam Server, you can remotely play back the recorded files by using the video player ViewLog. This provides you another playback option other than the Remote Playback application (see *Remote Playback on WebCam* earlier in this chapter).

1. The GV-System needs to allow the remote access first. Click the **Network** button, select **WebCam Server**, and enable **Run ViewLog Server**.
2. At the local PC, open a Web browser and type the address of the GV-System. The Single View page (Figure 6-16) appears.
3. On the left panel, click **Remote Play Back**, select **ViewLog** and then select the desired resolution. This dialog box appears. For the first-time user, you will be directed to the Download page and it is required to download the ViewLog program before you can run it. For details see *Download Center* later in this chapter.

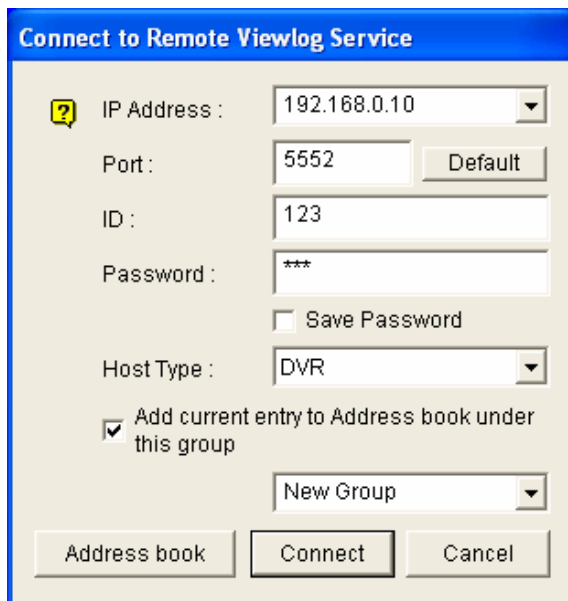

**Figure 6-50**

4. Type the IP Address, ID and Password of the GV-System. In the Host Type field, select the device type of the remote GV-System. Keep the default port as **5552**, or modify it if necessary.
5. Click the **Connect** button.

When the connection is established, you will see the video player ViewLog appears on the screen. Then you can access all ViewLog features for playback.

## Event List Query

The Event List Query function is similar to Advanced Search on the WebCam Remote Playback (RPB) but with a different GUI design and more functionality.

To search an event:

1. In the left panel, select one of the following query categories, and then click **Submit Query**:

- **Monitor:** monitored events
- **System:** system activities
- **Login:** user login/logout status
- **Counter:** counter events
- **POS:** POS transaction events

Note that the above categories are based on those of System Log in the Main System, so you can also locate the same event recorded in System Log.

2. Define the search criteria such as Event Type, Device, Information, Date and etc. The selection of search criteria may vary depended on query categories. Then click **Submit Query**. The search results if available will be listed in the text format.

3. To play back the attached video, click the video icon.

4. To graph the search results, click the **Chart** button.

5. To export the search results, select one of formats Txt, Html or Excel and then click the **Export** button.

The screenshot displays the 'Log query' interface. On the left, a sidebar lists query categories: Monitor (selected), System, Login, Counter, and POS. Below the sidebar is a 'Submit Query' button. The main area is titled 'Monitor' and contains search criteria fields: 'Event Type' (set to 'Motion'), 'Device' (set to 'Camera 1'), 'Information' (empty), and 'Date' (with two date ranges: '2014/11/07-00:00:00' and '2014/11/07-23:59:59'). A 'Submit Query' button is located to the right of these fields. Below the search criteria, there are buttons for 'Chart', 'Txt', and 'Export'. The search results are displayed in a table with the following data:

ID	Event Type	Device	Information	Time	Video
15	Motion	Camera 1		11/7/2014 11:03:56 AM	
16	Motion	Camera 1		11/7/2014 11:05:38 AM	
17	Motion	Camera 1		11/7/2014 11:08:33 AM	
18	Motion	Camera 1		11/7/2014 11:10:02 AM	

Below the table, there are two pagination indicators: '1 Page: 1/1, Total record(s): 4'.

Red arrows point from the following labels to the corresponding elements in the screenshot:

- Query categories: points to the left sidebar.
- Chart display: points to the 'Chart' button.
- Export data: points to the 'Export' button.
- Attached video: points to the video icons in the results table.

**Figure 6-51**

## POS Live View on WebCam

Through WebCam Server, it is possible to monitor the surveillance sites of POS or access control systems. You can access not only live video, but also transaction data or cardholder information.

1. Open a browser, and type the address of the remote GV-System. The Single View page (Figure 6-16) appears.
2. Select **POS Live View**. The remote POS Live View window appears.
3. Click the **Play** button, and type the valid user name and password to start the connection.

### The Remote POS Live View Window



Figure 6-52

The controls on the remote Post Live View window:

No.	Name	Description
1	Option	Brings up these options: Show Camera Name and Enable DirectDraw.
2	Change Camera	Selects the desired camera for display.
3	POS Live View	Brings up these options: Next Transaction, Previous Transaction and Freeze Event.
4	Zoom	Switches to full screen view.
5	File Save	Saves live video in the local computer.
6	Change Quality	Adjusts video quality in 4 levels.
7	Snapshot	Takes a snapshot of the displayed live video.
8	Stop	Terminates the connection to the remote GV-System.
9	Play	Connects to the remote GV-System.



## Instant Playback

You can play back the video instantly by double-clicking on any suspicious transaction items or cardholder's information.

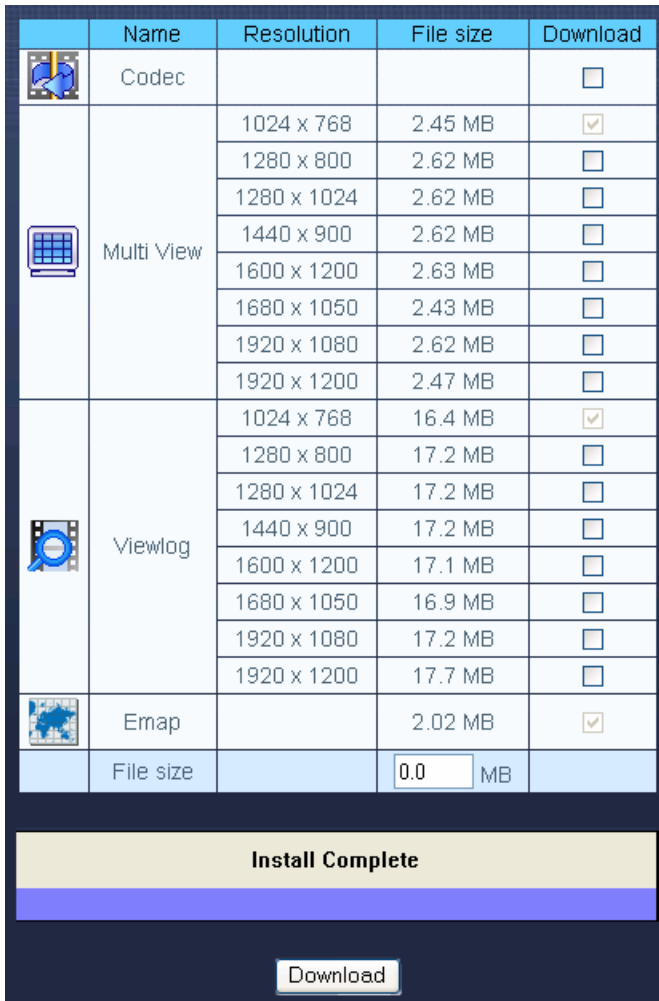

Figure 6-53

## Download Center

The Download Center provides you with an easy option to upgrade the codec, and decide what kind of viewing program should be downloaded to your local computer based on screen resolution required.

1. Click **Download** in the left panel of the Single View page (Figure 6-16). This page appears.



**Figure 6-54**

2. Check the desired programs. The **File Size** field will display the total file size of the selected programs.
3. Click **Download** and follow the on-screen instructions to install the programs. When the installation is complete, the message “*Install Complete*” will be displayed.

## Mobile Phone Applications

With the mobile phone capable of GPRS, 3G and Wi-Fi, you can receive live videos from your GV-System. The GV mobile phone applications and their major features are listed below:

<b>Handheld Device View</b>	<b>GView Version 2</b>
<b>OS Supported</b>	Windows Mobile 5.0 and 2003 for Pocket PC Windows Mobile 6 Classic and Professional
<b>Port</b>	Data Port: 8866, RPB Port: 5511
<b>Protocol</b>	TCP/IP (Streaming)
<b>Functions</b>	Video streaming, GV-Video Server support, PTZ control, I/O device control, Remote Playback (RPB) and etc.
<b>Handheld Device View</b>	<b>MSView Version 2</b>
<b>OS Supported</b>	Windows Mobile 5.0, 2003 for Smartphone
<b>Port</b>	Data Port: 8866, RPB Port: 5511
<b>Protocol</b>	TCP/IP (Streaming)
<b>Functions</b>	Video streaming, GV-Video Server support, PTZ control, I/O device control, Remote Playback (RPB) and etc.
<b>Handheld Device View</b>	<b>MSView Version 3</b>
<b>OS Supported</b>	Windows Mobile 6 Standard and Professional
<b>Port</b>	Data Port: 8866, RPB Port: 5511
<b>Protocol</b>	TCP/IP (Streaming)
<b>Functions</b>	Video streaming, GV-Video Server support, PTZ control, I/O device control, Remote Playback (RPB) and etc.
<b>Handheld Device View</b>	<b>SSView Version 2</b>
<b>OS Supported</b>	Java MIDP 2.0 or later
<b>Port</b>	Data Port: 8866
<b>Protocol</b>	TCP/IP (JPEG)
<b>Functions</b>	PTZ control, output control and etc.
<b>Handheld Device View</b>	<b>SSView Version 3</b>
<b>OS Supported</b>	Nokia S60 2nd Edition and 3rd Edition
<b>Port</b>	Data Port: 8866, RPB Port: 5511
<b>Protocol</b>	TCP/IP (Streaming)
<b>Functions</b>	Video Streaming, Remote Playback (RPB), PTZ control, output control and etc.
<b>Handheld Device View</b>	<b>3GPP</b>
<b>OS Supported</b>	Mobile phones with players supporting RTSP (Real Time Streaming Protocol)
<b>Port</b>	TCP Port: 8554, UDP Port: 17300-17380
<b>Protocol</b>	TCP/IP (Streaming)
<b>Functions</b>	Video Streaming, Remote Playback (RPB), Audio and etc.

For the 3G-enabled mobile phone, you can receive live video from the GV-System without installing the related GV mobile applications first. For the port settings of 3GPP, see *WebCam Server Settings* earlier in this chapter.

---

**Note:** When you access the GV-System by the mobile phone, you will be forwarded to the designated web page as shown below. If the displayed web page is different from this, please try to enter the IP address of the GV-System like this way: [http://\(GV-System\)/phonepwd.htm](http://(GV-System)/phonepwd.htm)

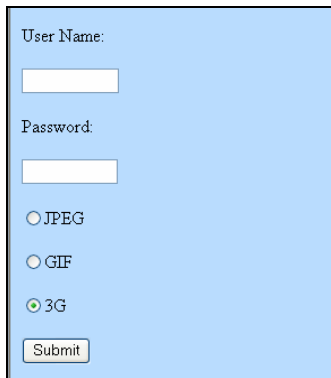

**Figure 6-55**

---

## PDA

GView V2 is a remote view application for Pocket PC device. It can run on PDA using Windows Mobile 5.0 and 2003.

When GView V2 detects the big screen panel of the mobile phone, images from the connected G-System will be horizontally rotated for a better view. Resolution is set to be CIF by default.

### GView Installation

GView V2 is included in the Surveillance System Software CD. This application should be installed in a PDA device with Microsoft Pocket PC operating system.

1. Plug your PDA via USB or COM port to a computer installed with **Microsoft ActiveSync** (The Microsoft ActiveSync program should come with your PDA software CD. Consult your PDA user's manual).
2. Run **Microsoft ActiveSync** in the connected computer. Make sure both the PDA and computer are synchronized.
3. Insert the Surveillance System Software CD to the computer. It runs automatically, and a window pops up.
4. Select the **Install V 8.2.0.0 System** item, and then click **Microsoft PDA Viewer V2**.
5. Follow the on-screen instructions to complete the installation.

## Activate the GView Function

To allow remote access to the GV-System, you must activate the Webcam server with the Mobile function enabled. See Figure 6-8.

## Connecting to GV-System

Once GView V2 is installed into your PDA, you can use it to monitor your GV-System. Make sure your PDA has wireless LAN adapter properly in place with access to the Internet.

1. Execute **GView V2** in your PDA.
2. Click the **Connect** button located at the lower left corner. This displays the Login screen.
3. Type the IP address of the GV-System you wish to connect, enter a valid username and password, and then click the **OK** button.

If logging in successfully, you will see video streaming to your PDA. Clicking the **Stop** button can exit the GView application.

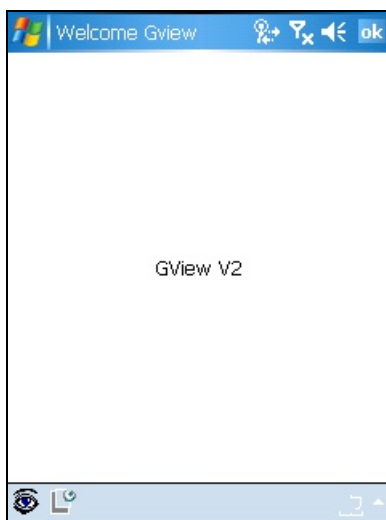

**Figure 6-56** Starting GView

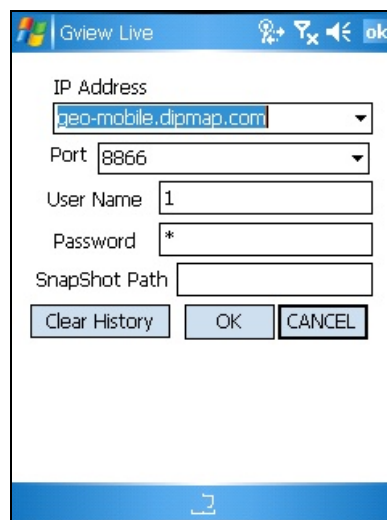
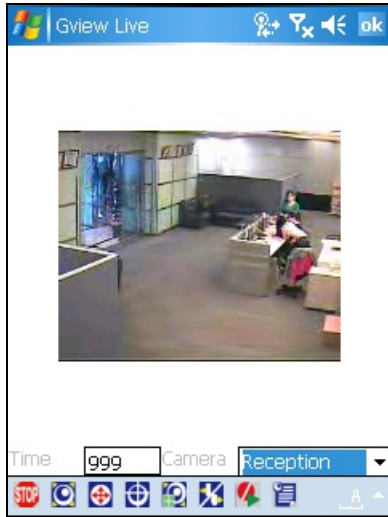

**Figure 6-57** Entering GV-server Info

## Other Functions

The major functions of GView V2 include live video monitoring, PTZ control, zooming control, and snapshot.

**[View Screen]**



**Figure 6-58**

**[PTZ Screen]**

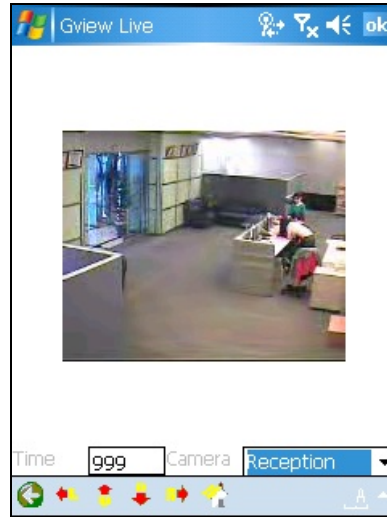

**Figure 6-59**

Buttons	Description
	Click it to stop the connection.
	Click it for Focus-in and Focus-out control
	Click it for Zoom-in or Zoom-out control.
	Click it to select the camera-preset positions.
	Click it to adjust the image quality.
	Click it for I/O Module Setting or to force outputs.
	Click it to start or stop recording.
	Click it to display the camera status.
Time <input type="text" value="999"/>	The supervisor is given the highest priority to control the PTZ camera and won't be restrained by 60-second time limit. When the supervisor logs in, the Timer shows 999.
Reception ▾	Use this drop-down list to switch cameras.
	Click it to return to the previous page.
	Use these buttons to control left, up, down and right of the PTZ cameras.
	Click it to return to home.

## Viewing and Controlling I/O Devices

To view and control the connected I/O devices, select the desired camera and click the  button (Figure 6-58).

### [I/O Monitoring Setting / Monitoring]



**Figure 6-60**

The number on the toolbar indicates the connected module. To view and control the input and output devices, click the number button.

### [I/O Setting]

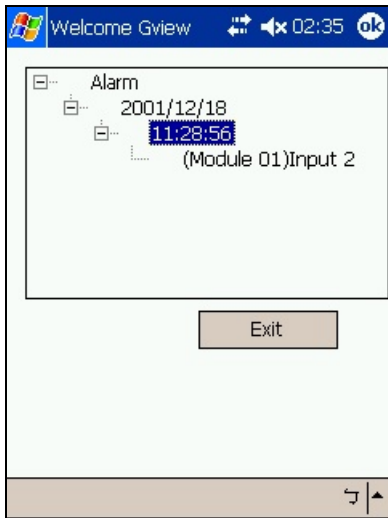

**Figure 6-61**

“I”: displays the status of triggered input devices. See Figure 6-60.

“O”: displays the connected output devices. See Figure 6-61.

**[Input/ Output Devices]**



**Figure 6-62 Input Devices**

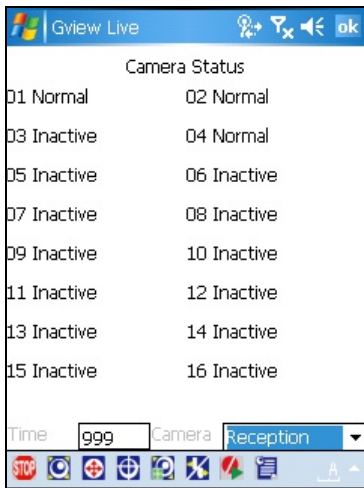

**Figure 6-63 Output Devices**

On the bottom toolbar of the Output Devices screen, the numbers indicates the connected output devices. Click the desired number to force the output.

**[Camera Status ]**

To view the camera status, click the  button (Figure 6-58).



**Figure 6-64**

This screen displays the status of camera activity. Three messages indicate the current camera status:

- **Normal:** The camera is turned on and not recording.
- **Inactive:** The camera is turned off.
- **Recording:** The camera is recording.



## I-Mode Phone

You can monitor your GV-System remotely with

- I-Mode phone, or
- Mobile phone supporting xhtml, chtml, or html and capable of GPRS.

When using i-Mode services, you do not pay for the time you connected online, but will be charged by the volume of data transmitted and/or received. Therefore, i-Mode will NOT receive live video streaming; instead, it will receive one image at a time and will not receive another unless it is requested to do so. To request another image, simply press the Enter key on your i-Mode phone. The images are in GIF or JPEG format with resolution of 96x72 pixels.

### Activating the i-Mode Function

In the Main System, click the **Network** button, select **WebCam Server**, click the **JPG** tab, and check the **Create JPEG/GIF file(s)** as shown in Figure 6-6. Your GV-System must use a global IP address and be accessible from the Internet.

### Connecting to GV-System

After activating the i-Mode function, you can now receive live images from the GV-System via an i-Mode phone. The interface and operation of your i-Mode phone may be different from the following example since the interface may vary from model to model.

1. Open the i-Mode menu, and select **Input Web Address**.
2. Enter the IP address of your GV-System in the Address column, and then press **OK**.



Figure 6-65 Opening the menu



Figure 6-66 Entering the IP address of GV-server

3. Type a valid user name and password, and then press **Submit**.

4. Select the desired camera channel, and then press **Enter**.

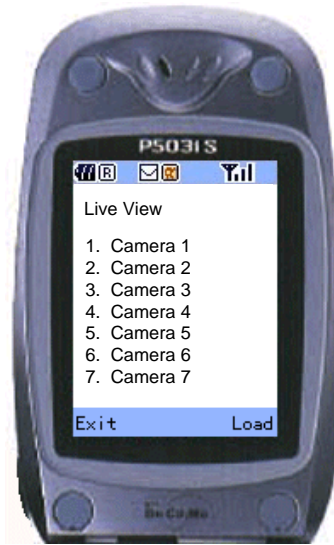

**Figure 6-67** Entering the use name and password    **Figure 6-68** Selecting a camera for live view

If you log in successfully, the i-Mode phone will start receiving live images from the GV-System.

## Windows Smartphone

With the MSView application, you can monitor your GV-System remotely via a Windows-based smartphone edition 2002, 2003 and 5.0.

### Installing MSView Version 2 / Version 3

1. Insert the Surveillance System Software CD. It runs automatically, and a window pops up.
2. Select the **Install V 8.2.0.0 System** item.
3. Select **Microsoft Smartphone Viewer V2** or **Microsoft Smartphone Viewer V3**, and then follow the on-screen instructions.
4. Locate **MSViewV2.exe** in the Smartphone Viewer V2 folder or **MsviewV3.exe** in the Smartphone Viewer V3 folder created in your computer. The default directory is C:\SmartPhone Viewer V2 or C:\SmartPhone Viewer V3.
5. Though the synchronization program such as **ActiveSync**, install **MsviewV2.exe** or **MsviewV3.exe** to your smartphone. Consult your smartphone user's manual for how to install a program to the smartphone.

### Activating the MSView V2 / V3 Function

To allow remote access to the GV-System, you must enable the Webcam server with the Mobile function activated. See Figure 6-8.

### Connecting to GV-System

The following operations may vary slightly for different modules.

1. Execute **MSViewV2.exe** or **MSViewV3.exe** in your smartphone. Figure 6-69 appears.
2. Select **Type** and then **Live**. Figure 6-70 appears.
3. Enter the IP address and port number of your GV-System, a login ID and password. Select **Control** and then **Connect**.

Once the connection is established, the live image will appear. You can use the scroll key on your smartphone to navigate camera channels. See Figure 6-71.

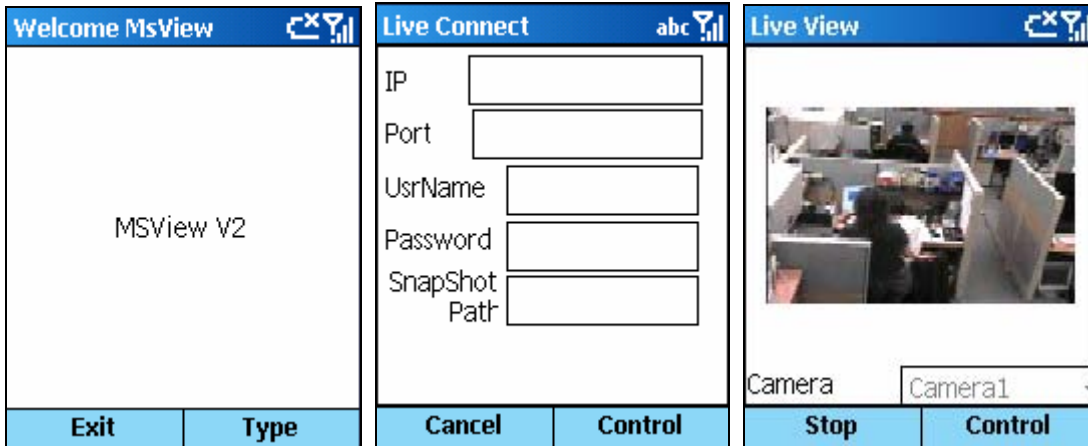

**Figure 6-69** MSView Main Screen **Figure 6-70** Entering GV-System Info **Figure 6-71** Viewing live camera

### Other Functions

In addition to live view, MSView V2 or MSView V3 offers the functions, such as zooming in/out a camera view and rotating images. Select the **Control** option to have these features.

## Symbian Smartphone

With the SSView V2 / V3 application, it's also possible to monitor your GV-System remotely via Symbian-based smartphone.

Two solutions are provided for the Symbian Smartphone:

- SSView Version 2 for Symbian OS edition 7.0
- SSView Version 3 for Nokia S60 2nd and 3rd Edition

### Installing SSView Version 2 / Version 3

To install SSView Version 2 for Symbian OS edition 7.0:

1. Insert the Surveillance System Software CD. It runs automatically, and a window pops up.
2. Select the **Install V 8.2.0.0 System** item.  
Select **Symbian Smartphone Viewer V2**, and follow the on-screen instructions.
3. Locate **SSViewV2.jad** and **SSViewV2.jar** in the Symbian Phone Viewer V2 folder created in your computer. The default directory is C:\Symbain SmartPhone Viewer V2.
4. Install **SSViewV2.jad** and **SSViewV2.jar** to your smartphone. Consult your smartphone user's manual for how to install a program to the smartphone.

To install SSView Version 3 for Nokia S60 2nd and 3rd Edition:

1. Insert the Surveillance System Software CD. It runs automatically, and a window pops up.
2. Select the **Install V 8.2.0.0 System** item.  
Select **Symbian Smartphone Viewer V3 (For Nokia S60 2nd and 3rd)**, and follow the on-screen instructions.
3. Locate **SSViewV3\_2nd.sis** or **SSViewV3\_3rd.sis** in the Symbian Phone Viewer V3 folder created in your computer. The default directory is C:\Symbain SmartPhone Viewer V3.
4. If your smartphone is of S60 2nd Edition, install **SSViewV3\_2nd.sis**. If your smartphone is of S60 3rd Edition, install **SSViewV3\_3rd.sis**. Consult your smartphone user's manual for how to install a program to the smartphone.

### Activating the SSView V2 / V3 Function

To allow remote access to the GV-System, you must enable the Webcam server with the Mobile function activated. See Figure 6-8.

## Connecting to GV-System

The following operations may vary slightly for different modules.

1. Execute **SSView** in your smartphone.
2. When the message *SSView V2 or SSView V3* appears, select **Options**, and select **Live Connect**.  
The Login screen appears.
3. Enter the IP address and port number of your GV-System, login username and password.
4. Select **Options**, and then select **Connect** to start the connection for live view.

## Quick Connection

The IP addresses of connected servers can be stored for quick connection in the future. Press the [**<**] and [**>**] buttons on the mobile device to select the desired server for connection.

## Other Functions

In addition to live view, SSView offers other useful functions, such as changing camera channels, zooming in a camera view, rotating images and seeing Server and WebCam information. Select **Options** to have these features.

## Fast Key Reference

To view the fast key lists of MultiView and PTZ control in MultiView, click the **Configure** button (No. 8, Figure 6-32), and click the **View** button in Fast Key field. The fast key list appears.

# Chapter 7

---

<b>E-Map Application .....</b>	<b>311</b>
<b>The E-Map Editor .....</b>	<b>311</b>
The E-Map Editor Window.....	312
<b>Creating an E-Map File .....</b>	<b>313</b>
Creating an E-Map File for a Remote Host .....	314
<b>Starting E-Map.....</b>	<b>315</b>
Setting the Pop-up Map Function .....	316
<b>Starting E-Map from a Remote Site.....</b>	<b>317</b>
The Remote E-Map Window .....	317
Logging in Different Hosts .....	318
Configuring the Remote E-Map Window .....	319
Viewing Host Information.....	320
Accessing Remote ViewLog.....	321
<b>E-Map Server .....</b>	<b>322</b>
Installing E-Map Server .....	322
The E-Map Server Window .....	322
Setting E-Map Server .....	323
Remote Monitoring via E-Map Server .....	323
Accessing Authentication Server Account Information .....	323



## E-Map Application

E-Map displays the monitoring area on an electronic map, by which the operator can easily locate the cameras, sensors and alarms triggered by motion or I/O devices. Topics discussed in this chapter include: creating an E-Map file with E-Map Editor, working with E-Map in the Main System, working with E-Map on the WebCam server and E-Map Server.

### The E-Map Editor

The E-Map Editor program allows you to import a floor plan in BMP, GIF and JPG formats, and use the icons of cameras and I/O devices to edit a map per your requirement.

The E-Map Editor program comes with the installation of Main System. Click the Windows **Start** menu, point to **Programs**, select **GV folder** and click **EMap Editor**. The E-Map Editor window will appear.

## The E-Map Editor Window

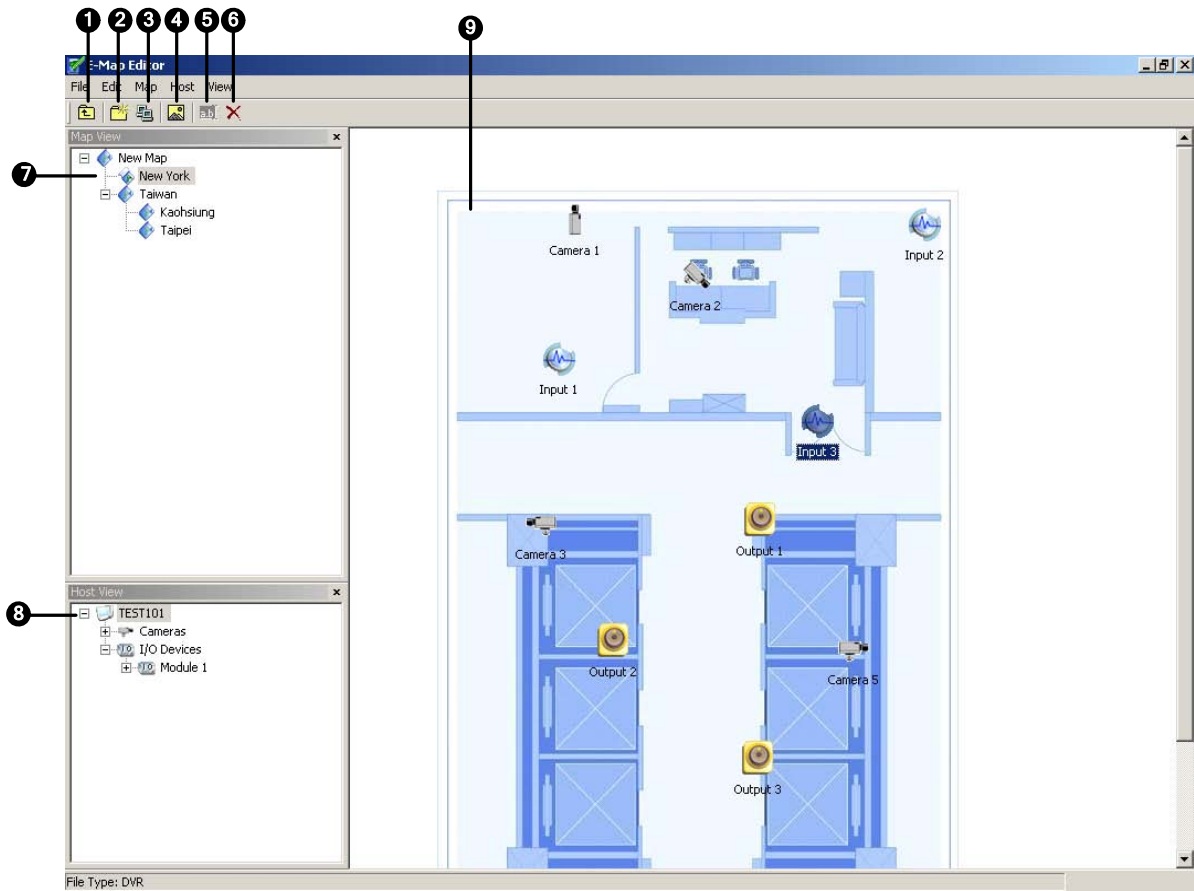

**Figure 7-1** The E-Map Editor Window

The controls in the E-Map Editor window:

No.	Name	Description
1	Up	Goes back to the previous E-Map file.
2	Add Map	Adds an E-Map file.
3	Add Host	Adds a host folder of DVR and/or GV-Video Server.
4	Load Map	Imports a floor plan.
5	Rename	Renames an E-Map file and/or folder.
6	Delete	Deletes an E-Map file and/or folder.
7	Map View	Tree view of E-Map files and/or folders.
8	Host View	Tree view of host folders.
9	Floor Plan	The window displays the imported graphic file.

## Creating an E-Map File

To create and edit an E-Map file, follow the steps below.

1. Click the **Add Map** button (No.2, Figure 7-1) on the toolbar. A New Map file will be created in Map View and the Floor Plan window separately, as illustrated below.

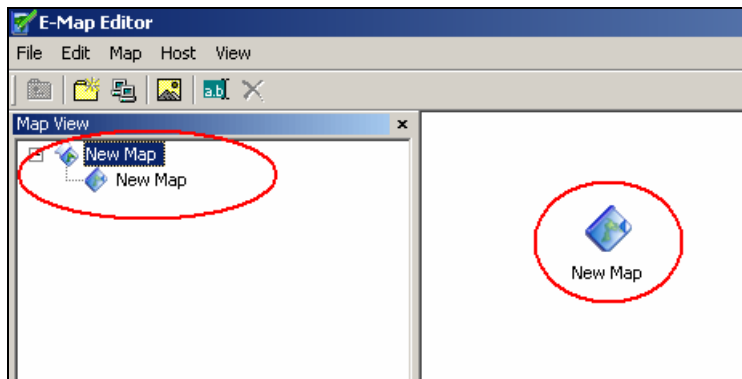

*Figure 7-2 Creating a new map*

2. Click the **New Map** file in Map View, and then click the **Load Map** button (No. 4, Figure 7-1) to import a graphic file. The file will open in the Floor Plan window (Figure 7-1).
3. Double-click the local server folder in Host View. The program will automatically detect the number of cameras and I/O devices already installed at the server, and show up their separate icons.
4. Drag and drop these icons from Host View onto the map in the Floor Plan window.
5. The E-Map Editor lets you set the orientation of camera icons and change the icons. Right-click any camera icon to call up a menu, and select the direction where you want the camera to point to. Or change the camera icon into the dome icon.
6. Click **File** in the window menu, and select **Save to DVR** or **Save to File** to save the created E-Map file.

## Creating an E-Map File for a Remote Host

With E-Map Editor, you can create E-Maps for your local host, as well as remotely for other hosts. E-Maps created for remote hosts are saved and viewable only at the server where they are created. And they are only functional when connected to the WebCam server.

1. Click the **Add Host** button (No. 3, Figure 7-1) on the toolbar. A new host folder then is added in Host View.
2. Right-click the **Host** in Host View, and then select **Host Settings** to display the following dialog box.

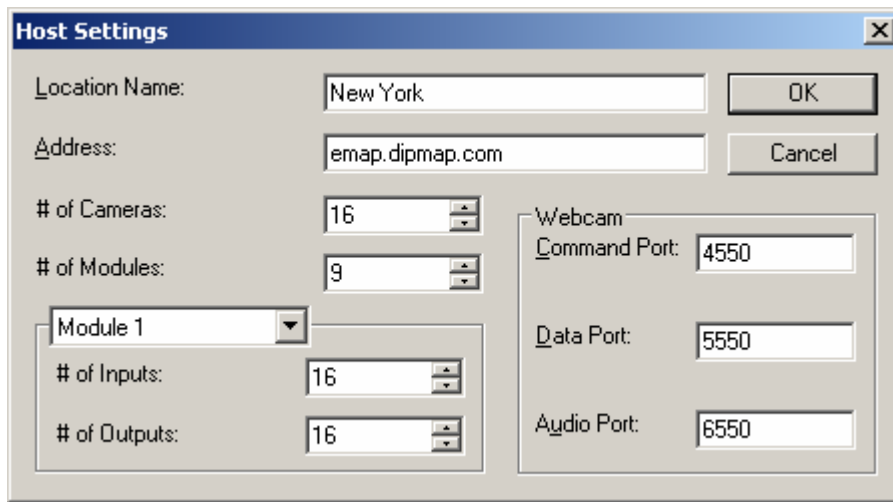

The image shows a 'Host Settings' dialog box with the following fields and values:

Field	Value
Location Name:	New York
Address:	emap.dipmap.com
# of Cameras:	16
# of Modules:	9
Module 1 (selected):	Module 1
# of Inputs:	16
# of Outputs:	16
Webcam Command Port:	4550
Data Port:	5550
Audio Port:	6550

**Figure 7-3** Host Settings

3. Type the remote host's name, IP address, how many cameras, I/O modules, inputs, outputs are installed at the host, and port information. Then click **OK**.
4. Follow the steps instructed in *Creating an E-Map File* to create a file for the remote host.

## Starting E-Map

After creating an E-Map file, go to the Main System. Click the **ViewLog** button and then select **E-Map** to display the following E-Map Viewer window. Double-click any E-Map file of the local host to open it.

**Note:** If you have created the E-Map files for remote hosts, these files will also be displayed in the E-Map Viewer window but won't function here. They only work on WebCam that is discussed later.

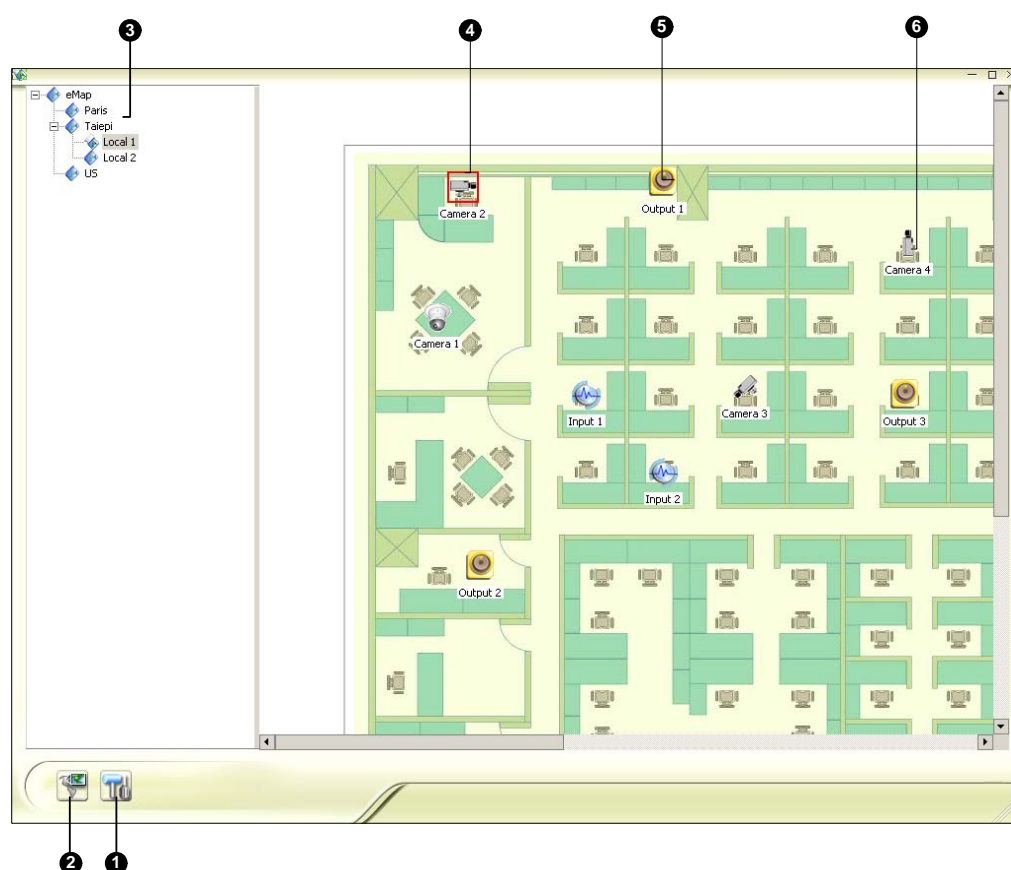

**Figure 7-4** The E-Map Viewer Window

The controls in the E-Map Viewer window:

No.	Name	Description
1	Popup Settings	Selects desired cameras and I/O devices for the pop-up map function.
2	Toggle Popup	Toggles between popup and non-popup function.
3	Tree View	The tree view of E-Map files and folders.
4	Flashing Icon	The flashing icon represents a triggered camera or an I/O device.
5	Output Icon	Manually forces an output device.
6	Camera/Dome Icon	Views the live video associated with that camera/dome.

## Setting the Pop-up Map Function

The E-Map Viewer window can be set to pop up with the flashing icon indicating that a camera or an input device is triggered. To set up the function, follow the steps below.

1. Click the **Popup Settings** button (No.1, Figure 7-4). Select desired cameras and input devices for the application, and specify **Dwell Time** for the interval between two pop-up maps.
2. Click the **Toggle Popup** button (No.2, Figure 7-4) to enable the function.
3. Minimize the E-Map Viewer window. Once any camera or input device is triggered, the map will pop up on your screen immediately.

## Starting E-Map from a Remote Site

Activating and configuring E-Map over a web browser is possible by the WebCam server. To do so, follow the steps below.

1. At the local server equipped with the GV-System, click the **Network** button and select **WebCam Server** to display the Server Setup dialog box. Click **OK** to start the WebCam server.
2. At the client PC, open the web browser and type the address of the local server. Once the connection is established, the Single View page will appear.
3. On the left panel, click **E-Map** to display the E-Map window on the client PC.

### The Remote E-Map Window

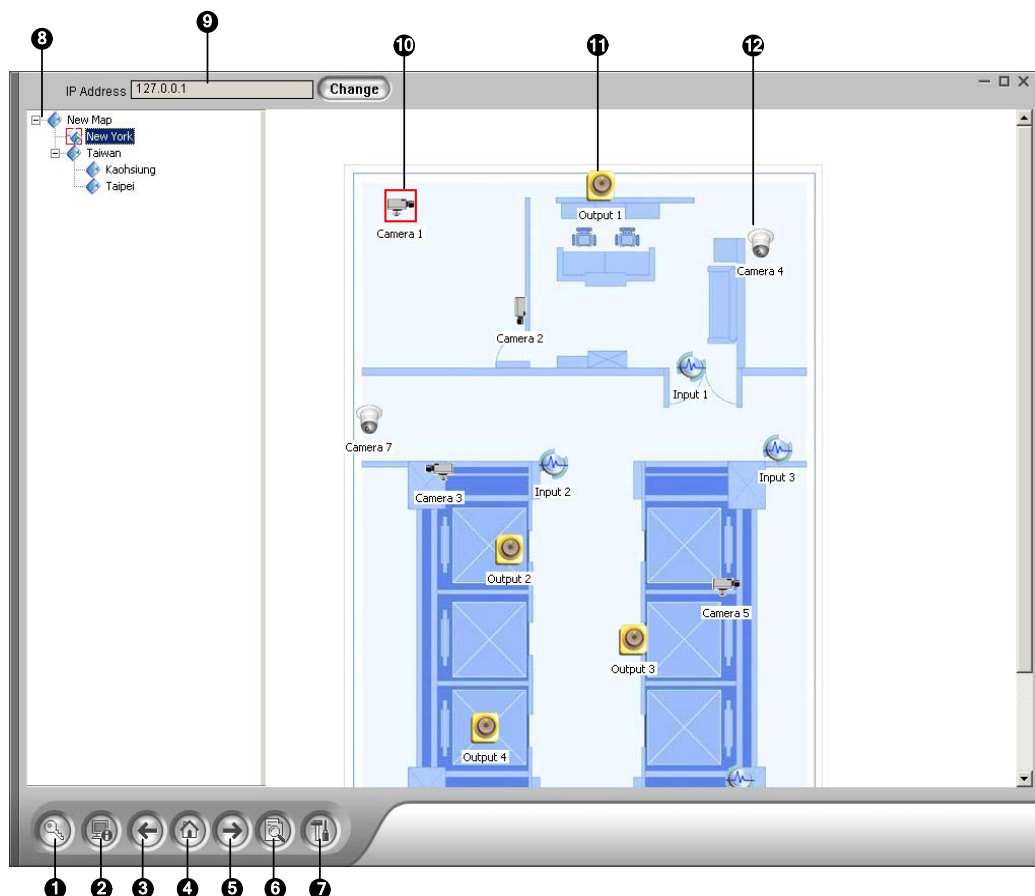

Figure 7-5 The Remote E-Map Window

The controls in the Remote E-Map window:

No.	Name	Description
1	Login	Click to login up to 500 host servers.
2	Host Information	Click to view the information of incoming events upon motion detected and I/O devices triggered.
3	Previous	Click to go to the previous E-Map file.
4	Home	Click to back to the top of the tree view.
5	Next	Click to go to the next E-Map file.
6	ViewLog	Click to access the Remote ViewLog function.
7	Configure	Click to configure the Remote E-Map window.
8	Tree List	The list displays all created E-Map files and folders.
9	IP Address	Displays the IP Address of the connected host.
10	Flashing Icon	The flashing icon represents a triggered camera or I/O device.
11	Output Icon	Click to manually force the output device.
12	Camera/Dome Icon	Click to view the live video associated with that camera/dome.

## Logging in Different Hosts

When the client PC connects to the WebCam server, all the E-Maps saved in the local server will be downloaded to the client PC, with the E-Map files of 500 hosts at most. The E-Maps created for remote hosts can only function on WebCam after you log in these hosts. You can login 500 hosts at a time.

Click the **Login** button (No. 1, Figure 7-5) to display the following Login window.

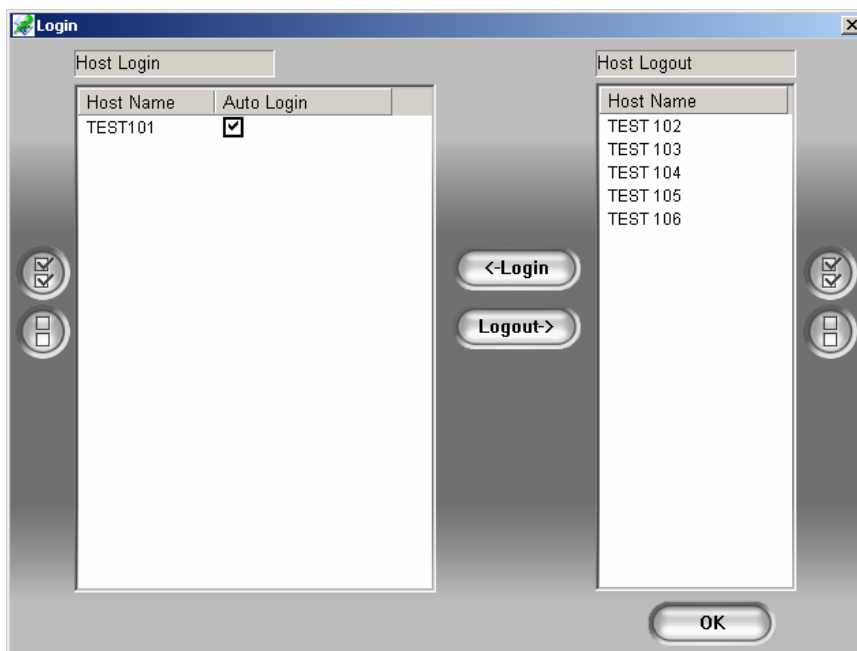
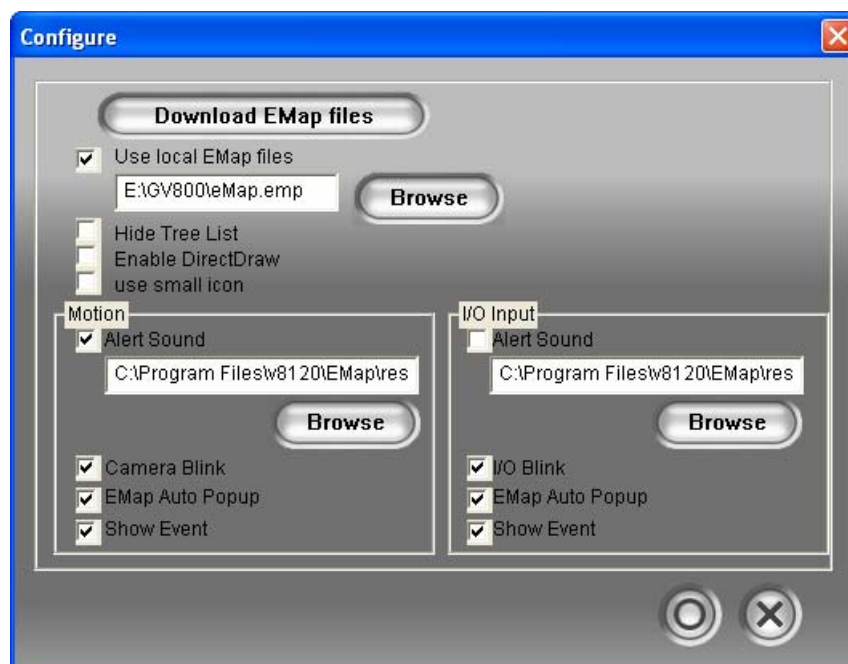

**Figure 7-6** Logging in different hosts



## Configuring the Remote E-Map Window

Click the **Configure** button (No. 7, Figure 7-5) to display the following dialog box:



*Figure 7-7 The Configure Dialog Box*

**[Download EMap files]** Click to download E-Map files from the local server to the client PC. This option can reduce network load when you want to view E-Maps of multiple hosts.

- **Use local EMap files:** Once downloading E-Map files to the client PC, you can use these E-Map files for connection.
- **Hide Tree List:** Check to hide the tree list.
- **Enable DirectDraw:** The DirectDraw is enabled by default. Some VGA cards might not support DirectDraw and can produce distorted frames. In this case, disable the feature.
- **Use small icon:** The Remote E-Map uses the large icons of cameras and I/O devices by default. Check this option if you want to use small icons.

### **[Motion] / [I/O Input]**

- **Alert Sound:** Check this option and assign a .wav file to alert the operator when motion is detected or I/O devices are triggered.
- **Camera Blink, I/O Blink:** When cameras or I/O devices are triggered, their icons on the E-map flash. Uncheck this option if you don't want to see the flashing icons.
- **EMap Auto Popup:** When cameras or I/O devices are triggered, the related map will pop up on the screen instantly. Check this option and minimize the Remote E-Map window for the application.
- **Show Event:** Check to display motion or I/O triggered events on the Host Information window.

## Viewing Host Information

The Host Information window lists camera and I/O device trigger information. Click the **Host Information** button (No. 2, Figure 7-5) to display.

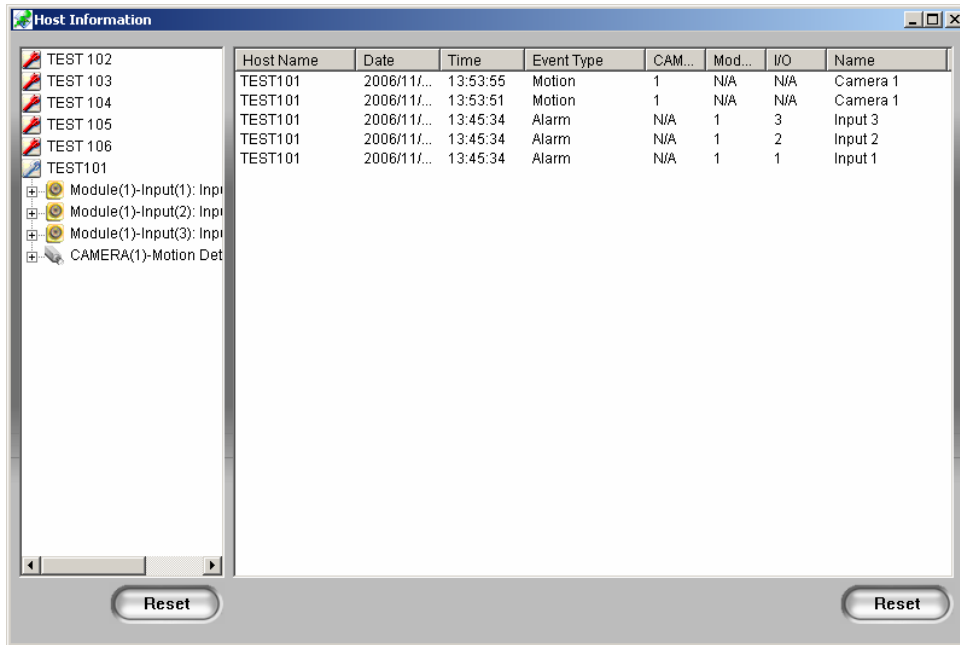

**Figure 7-8** Host Information

The Host Information window allows you to play back events happened in the host sites. Double-click any camera event in the left hand list to display the remote playback window. With this window, you can play back an event, speak to the host site and take a snapshot, as well as download the event to the client PC.



**Figure 7-9** The Remote Playback Window

## Accessing Remote ViewLog

On the Remote E-Map window, the **ViewLog** button (No.6, Figure 7-5) is designed for the Remote ViewLog function, giving you remote access to the recorded files of DVR and playing back video by the player ViewLog.

For details on starting the Remote ViewLog service, refer to *Remote ViewLog on WebCam* in Chapter 6.

## E-Map Server

The E-Map Server is an independent application, designed to create E-Maps for different DVRs and run without the GV-System.

### Installing E-Map Server

1. Insert the Surveillance System Software CD to your computer. It will run automatically, and a window appears.
2. Select the **Install V8.2.0.0 System** item.
3. Click **E-Map Server**, and then follow the on-screen instructions.

### The E-Map Server Window

Go to Windows **Start**, point to **Programs**, select **eMapServer**, and then click **E-Map Server**. This window appears.

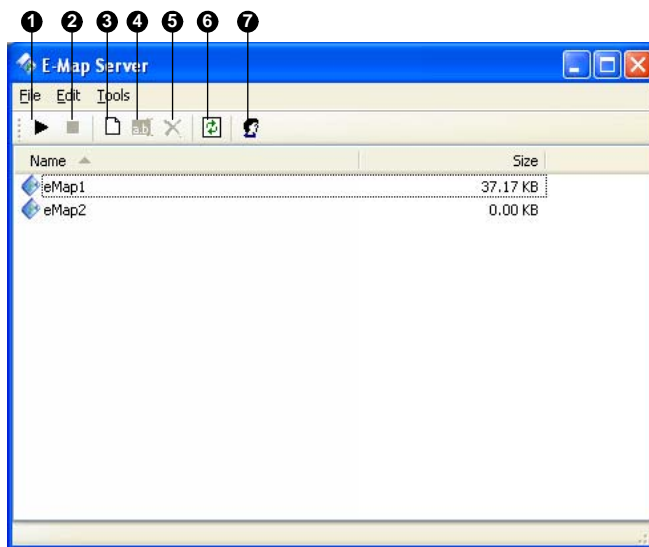

**Figure 7-10**

The controls on the E-Map Server window:

No.	Name	Description
1	Start Service	Starts the E-Map Server.
2	Stop Service	Stops the E-Map Server.
3	New	Creates a new E-Map file.
4	Rename	Renames the E-Map file.
5	Delete	Deletes the E-Map file.
6	Refresh	Refreshes the E-Map Server window.
7	Accounts	Creates user accounts of the E-Map Server.

## Setting E-Map Server

Before starting the E-Map server, you have to create e-map files and user accounts.

1. Click the **New** button (No.3, Figure 7-10) to create e-map(s). For details on creating an e-map file, see “Creating an E-Map File,” earlier in this chapter.
2. Click the **Accounts** (No. 7, Figure 7-10) button to create a user account that will use the server.

## Remote Monitoring via E-Map Server

Via E-Map Server, you can monitor different surveillance sites on electronic maps from any computer accessible to Internet.

1. Open the web browser and type the address of the E-Map server.
2. After entering the valid user name and password for login, you will be prompted to select the desired e-map file (.emp file),
3. Click **OK**. The Remote E-Map window appears.
4. Click the **Login** button (No.1, Figure 7-5) to select the desired host(s) to access videos and I/O devices.

---

**Note:** The host (DVR) needs to give the access privilege by enabling the **WebCam Server**.

---

## Accessing Authentication Server Account Information

With the connection to Authentication Server, the E-Map Server can access the Authentication account settings. For details see *Authentication Server* in Chapter 10.

## Chapter 8

---

### Live Viewing Using Remote Applications .. 325

<b>Remote View .....</b>	<b>325</b>
Setting Up Remote View.....	325
Working with My Favorite .....	328
Camera Zoom Function.....	329
Playing with Screen View Window Functions.....	329
Playing Back Video Files in Q-View .....	330
Preference Settings .....	330
Remote PTZ and I/O Function.....	332
Full Screen View.....	333
<b>IP Multicast .....</b>	<b>334</b>
Setting Up IP Multicast .....	334
Starting IP Multicast .....	334

# Live Viewing Using Remote Applications

The system is supplied with two remote applications.

- Remote View System
- IP Multicast System

## Remote View

Remote View is used to remotely monitor live videos from Main System, through modem dial-up or TCP/IP connection. Each Remote View is limited to only one login at a time. However, you may open multiple Remote Views in one workstation and each login to a different main system.

## Setting Up Remote View

The Remote View software is included in the Surveillance System Software CD. The application is to be installed at the client PC with modem dial-up or TCP/IP network access. The following is the minimum PC specifications for this application:

OS	Windows 2000, XP, 2003 Server, Vista
CPU	Pentium 500 (minimum)
Memory	128 MB RAM
Hard Disk	20 GB (minimum)
VGA	NVIDIA GeForce II 32 MB, 800 x 600 screen resolution (minimum)
Network	TCP/IP, Modem Dial-up

## Setting Up the Connection

Remote View allows two connection methods, and each are set up as follows.

### To set up modem connection:

1. Make sure modems at client PC and at sever PC are already setup. The system currently supports only external modems.
2. Click the **Network** button on main screen and enable **Modem Server** from menu.
3. In the MultiCam Remote Viewer, click **Preference** and then select **Configure Modem**. Select the network to use from drop-down list.
4. Click the **Connect** button from menu bar of Remote View, and then select **Dial-Modem** from menu to bring up the Connect dialog box, as shown:

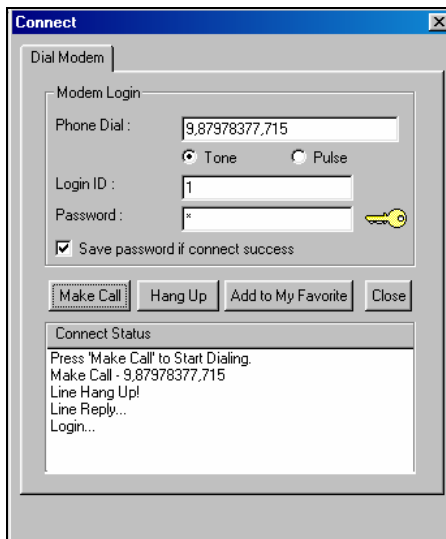

*Figure 8-1 Making connection to GV system through dial-up connection.*

5. In the Phone Dial field, type the telephone number you wish to use (this column memorizes 10 most recently used telephone numbers).
6. Enter a valid user ID and password, and then click the **Make Call** button. Messages should appear in the Connect Status window when the connection is established, shown in Figure 8-1.

### To set up TCP/IP connection:

1. Make sure both your client PC and the sever PC have access to TCP/IP network.
2. Click the **Network** button on main screen and enable **TCP/IP Server** from menu.



- In the MultiCam Remote Viewer, click the **Connect** button and select **Internet/Intranet\_TCP/IP** to bring up the following dialog box:

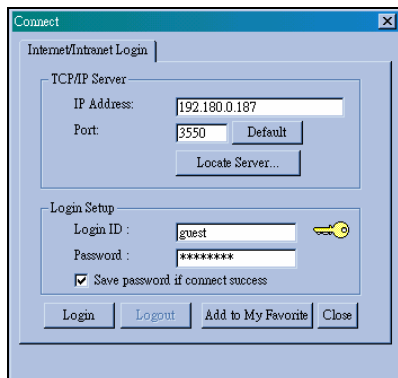

**Figure 8-2**

- In the IP Address field, type the IP address or domain name of the system you wish to connect to. The field memorizes 10 most recently used addresses.
- Type in port number in Port field. Use default value if you are not sure what to enter for this field.
- Enter a valid user ID and password and then click the **Login** button. Video stream should appear when connection succeeds, as shown:

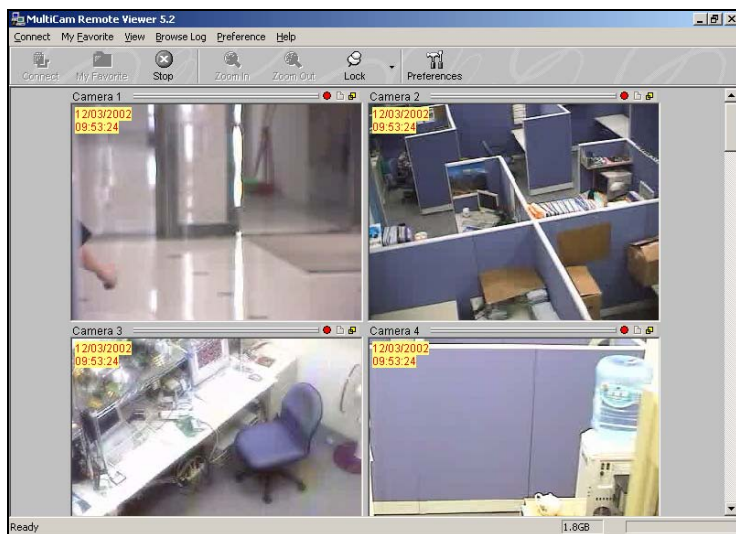

**Figure 8-3**

Functions of toolbar buttons are listed in following table:

Button	Description
Connect	Selects modem dial-up or TCP/IP connection.
My Favorite	Adds to My Favorite
Stop	Terminates network connection
Zoom In	Enlarges video.
Zoom Out	Shrinks video.
Lock	Locks a particular camera.
Preferences	Brings up the preferences setting window.

## Working with My Favorite

My Favorite provides for fast access to pre-set connection to main system. Several settings are available for this feature.

### To add a connection to My Favorite:

1. Click **My Favorite** button from menu bar.
2. Select **Add to My Favorite** from the menu. The Add to My Favorite dialog box appears.

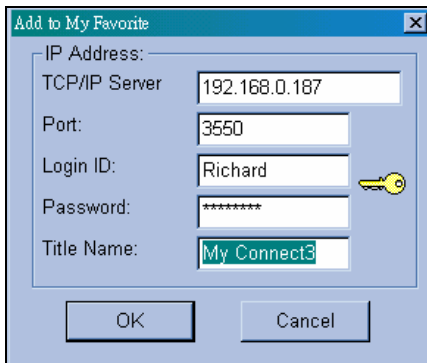
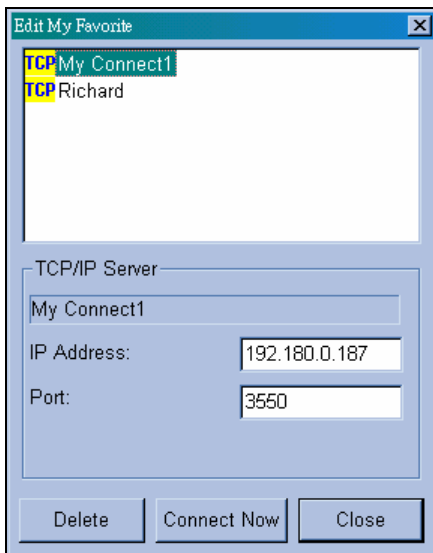

**Figure 8-4**

3. Enter the proper information and give a name to the new connection, and then click **OK**.

### To edit My Favorite:

1. To change information in My Favorite, click **My Favorite** button from menu bar.
2. Select **Edit My Favorite** from menu.
3. Select a connection you wish to edit.



**Figure 8-5**

### Go to My Favorite:

Once a connection is added, it is listed in menu. Click the connection from menu to login a system.

## Camera Zoom Function

Click the Zoom In and Zoom Out buttons in the toolbar to enlarge and shrink a particular camera view, here are the steps:

1. Click on the view screen you wish to zoom.
2. Click the **Lock** button from the toolbar to lock the camera.
3. Click either the **Zoom In** or the **Zoom Out** buttons, and then click on the locked camera.

## Playing with Screen View Window Functions

All live video is displayed in the screen view window, shown as follow:

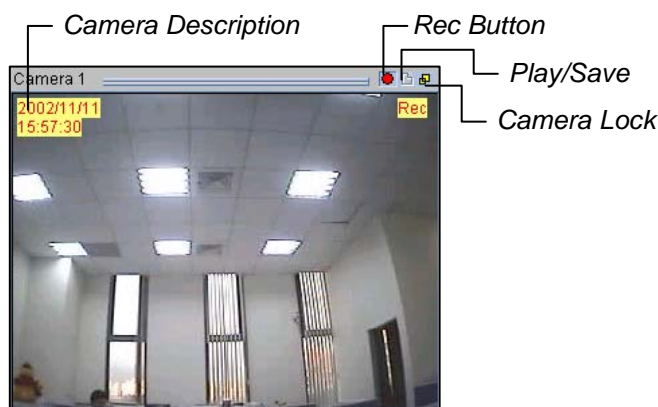

**Figure 8-6**

Icons appear in view screen represent:

Button	Description
Time Indicator	Indicates current date and time. Color of the text and the background can be changed in Preferences.
Rec	Starts, stops, pauses, and resumes recording.
Play/Save	Plays and saves recorded video files.
Camera Lock	Locks the image to apply zoom in, zoom out function.

**Note:** The Rec button saves the video files only temporarily as a buffer file. Therefore it saves only one video clip at a time. If you wish to save the files permanently, click the **Play/Save** button and select **Save as** to save the video clip in AVI format.

## Playing Back Video Files in Q-View

Click **Play/Save** button found in the camera screen, and select **Play**. This brings up the program Q-View, which is used for instant playback for video files temporarily saved in the Temporarily Record Buffer, created when Rec button is pressed.

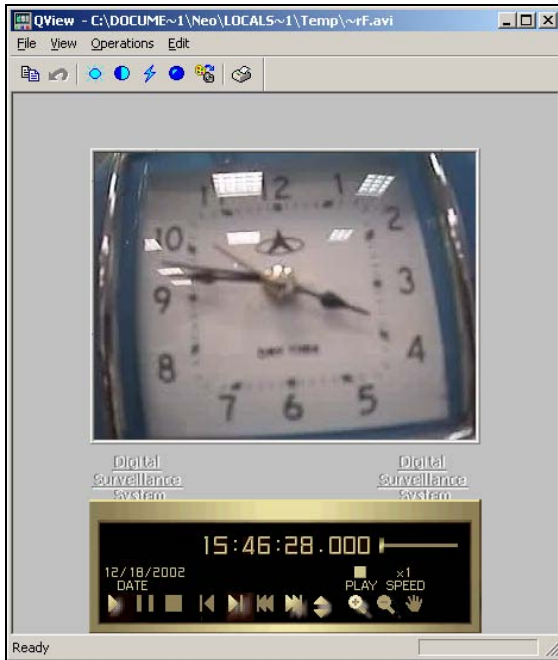

**Figure 8-7**

## Preference Settings

Click the **Preferences** button from the toolbar to bring out the corresponding dialog box, shown as:

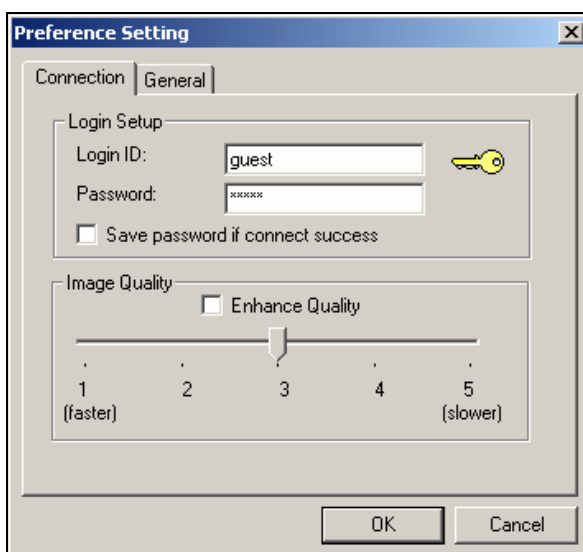

**Figure 8-8**

The following options are available on the Connection tab of the Preference Setting:

**[Login Setup]** Specify user name and password for Remote View.

**[Image Quality]** Specify the compression ratio of the video. Lower number gives higher compression, smaller file size, but the image quality will suffer.

There are also options available on the General tab:

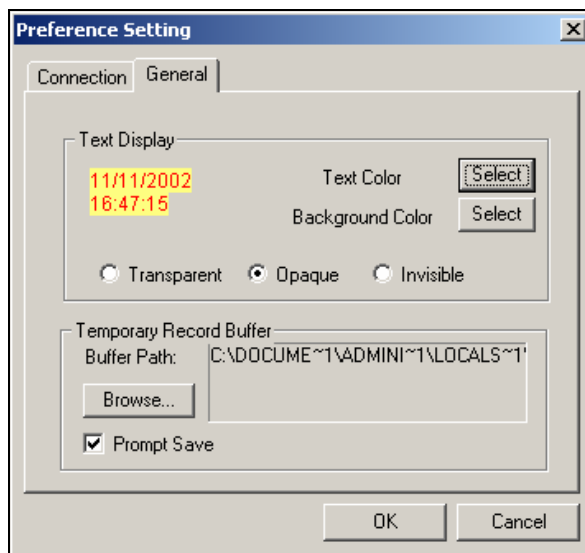

Figure 8-9

**[Text Display]** Sets camera description's text color and background color. 3 options are available to present the camera description: **Transparent** (text only no background), **Opaque** (text and background), and **Invisible** (no text and no background).

**[Temporary Record Buffer]** Determines a temporary folder that holds recording videos.

## Remote PTZ and I/O Function

If you have installed PTZ or I/O devices on the connected main system, then you will be able to control these devices through TCP/IP or dial-up network.

To use remote PTZ control:

Select **View, PTZ Device**, from the menu bar to bring up the PTZ control panel. Use the **PTZ select** buttons to choose the type of camera you wish to control. The control panel may look slightly different depending on camera model.

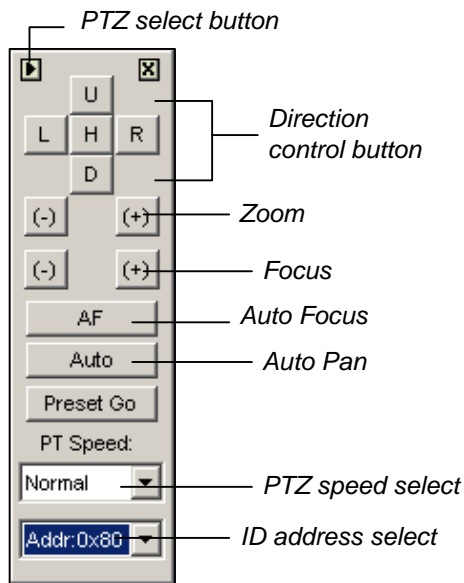

**Figure 8-10**

To use Remote I/O control:

Select View, I/O Module, from the menu bar to bring up the I/O control panel. Remote View allows you to control only the output devices. Click on the Output signal buttons to send signal to the output device.

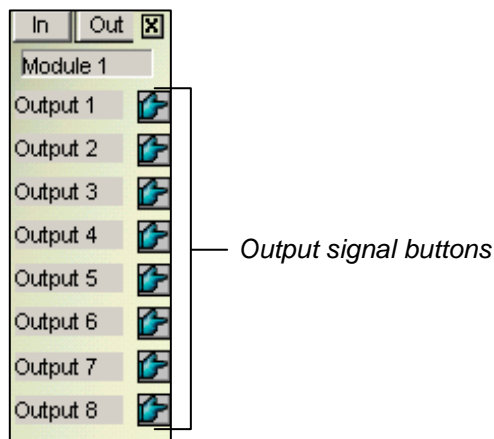

**Figure 8-11**

## Full Screen View

Click **Connect** button and select **Full Screen Mode** from the menu. The full screen mode provides a larger viewing area for the cameras. There are four functional buttons located at the right hand side that allows you to access to some of the basic functions.



Figure 8-12

## IP Multicast

It is possible to monitor several GV-Systems within a LAN network, through the use of IP Multicast. An IP Multicast allows maximum of ten connections at a time. After the Live X button pressed, IP Multicast automatically connects to the Main System within the LAN network.

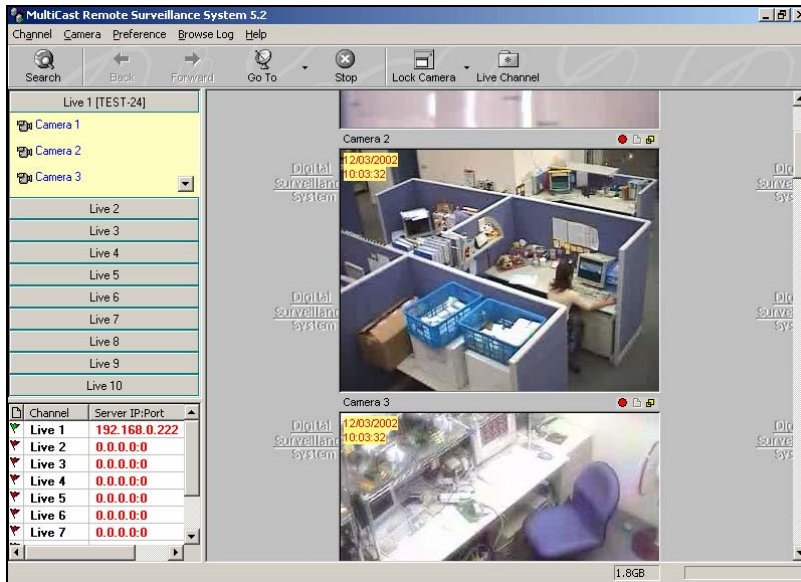

Figure 8-13

## Setting Up IP Multicast

The IP Multicast software is included in the Surveillance System Software CD. The application is to be installed at the client PC within LAN network access. PC requirements are the same as those for Remote View, described in the previous section.

## Starting IP Multicast

1. Make sure both the client PCs and the server PC are properly set up in local area network (LAN).
2. Click the **Network** button in Main System and select **Multicast Server** to allow connection from client PC. Follow this same step to set up all GV-Systems you wish to connect to IP Multicast.
3. Go to **Windows Start, Program, system folder**, and then IP MultiCast System from menu. Run the system at the client PC.
4. Click the **Search** button from toolbar so IP Multicast finds all GV-Systems available for connection within the network. Systems connected to IP Multicast are listed at the lower-left pane with their server IP.
5. Click the **Live** bar to view the desired system. You may be asked to enter Login ID and Password. Make sure your ID is given the privilege to view. All cameras open to the ID will be displayed.



6. To end a connection, click the **Stop** button from toolbar.

Functions of toolbar buttons are listed in following table:

Button	Description
Search	Finds all main systems available for connection within the network.
Back	Goes to previous surveillance screen.
Forward	Goes to next surveillance screen.
Go To	Selects a specific system.
Stop	Ends a connection.
Lock Camera	Locks a particular screen view.
Live Channel	Click to view or to hide a connection.

Icons found at the left pane represent:

Button	Description
Live x	Click to view available cameras in the selected system.
Flag	Green flag represents the system is connected; red means disconnected.

The rest of the functions in IP Multicast are much the same to those in Remote View. For details on using functions in screen views, refer to *Playing with Screen View Window Functions*, earlier in this chapter; to set the Preference dialog box, refer to *Preference Settings*; for features available for full-screen, refer to *Full Screen View*. Video files are also played back in Q-View; refer to *Playing Back Video Files in Q-View*.

**Note:** Since Q-View only saves one most recently viewed video file in the Temporarily Record Buffer, following message may appear when try to record a second file:

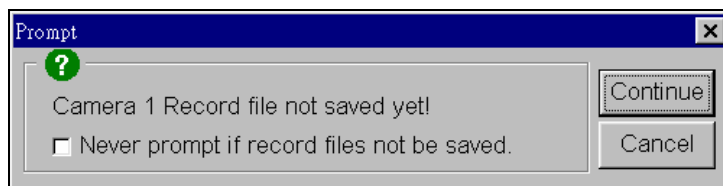

**Figure 8-14**

This message is to remind you that the video file previously played back has not been saved. Clicking **Continue** would overwrite the previous file. To always save viewed video files to a permanent location, use **Play/Save** button in screen view, instead of the Rec button.

# Chapter 9

---

<b>Short Message Service.....</b>	<b>337</b>
<b>Installing SMS Server .....</b>	<b>337</b>
<b>The SMS Server Window.....</b>	<b>338</b>
<b>SMS Server Setup.....</b>	<b>339</b>
Device Settings.....	339
Server Settings .....	340
Account Settings.....	343
<b>SMS Log.....</b>	<b>345</b>
Setting SMS Log.....	345
Viewing SMS Log .....	345
<b>Password Security.....</b>	<b>347</b>
<b>Connecting GV-System to SMS Server.....</b>	<b>347</b>
<b>Setting Mobile Numbers.....</b>	<b>349</b>

## Short Message Service

Via a GSM/GPRS modem, GV-System lets you send SMS (Short Message Service) messages when an alert condition happens. The modem can be installed at either a separate server, or the same computer/server equipped with GV-System. This chapter introduces how to manage a GSM/GPRS modem with the GV-developed SMS Server program, and how to configure the Main System to send out SMS alerts.

### Installing SMS Server

To install the SMS Server application, follow these steps:

1. Insert the Surveillance System Software CD to the PC connected to a GSM/GPRS modem. It will run automatically, and a window appears.
2. Select the **Install V 8.2.0.0 System** item.
3. Click **SMS Server**, and follow the on-screen instructions.

## The SMS Server Window

Run the SMS Server program from the Start menu. The following window appears.



**Figure 9-1** The SMS Server Window

The controls in the SMS Server window:

No.	Name	Description
1	Start/Stop Service	Starts or stops the SMS Server.
2	SMS Log Setting	Sets up the SMS Log.
3	Account Setting	Creates and edits accounts.
4	Server Setting	Sets up the SMS Server.
5	Device Setting	Sets up the GSM/GPRS modem.
6	Exit	Logs out administrator, changes password or exits the SMS server.

## SMS Server Setup

Before starting the SMS service, you must configure these three settings: (1) Device Settings, (2) Server Settings, and (3) Account Settings.

### Device Settings

1. Click the **Device Setting** button (No. 5, Figure 9-1), and then select **GSM Module**. The following dialog box appears.

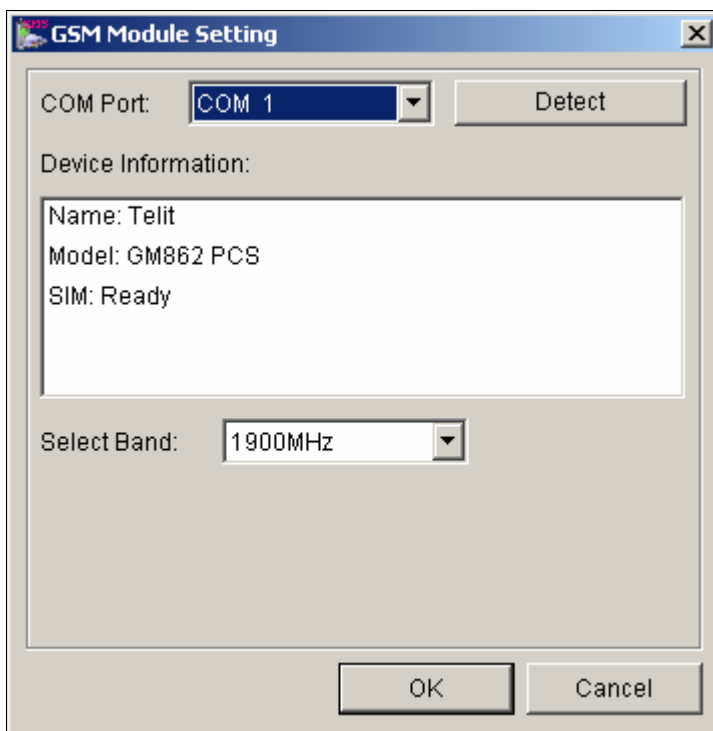

**Figure 9-2** GSM Module Setting

2. Select the **COM port** connecting to a GSM/GPRS modem.
3. Click the **Detect** button to detect the modem.
  - If the connection between the modem and the computer is established, the message will show in the Device Information field: *Name: (Manufacturer), Module: xxx, SIM Ready.*
  - If the connection fails, the display will be shown as: *No usable device in COM xxx.*
4. If you are using a tri-band modem, select **1900** or **1800 MHz** from the drop-down list of Select Band.
5. Click **OK** to apply above settings.

## Server Settings

Click the **Server Setting** button (No. 4, Figure 9-1) to display the following Server Setting dialog box. There are three major tabs in the dialog box: (1) General, (2) Message Filter, and (3) Notify

### [General]

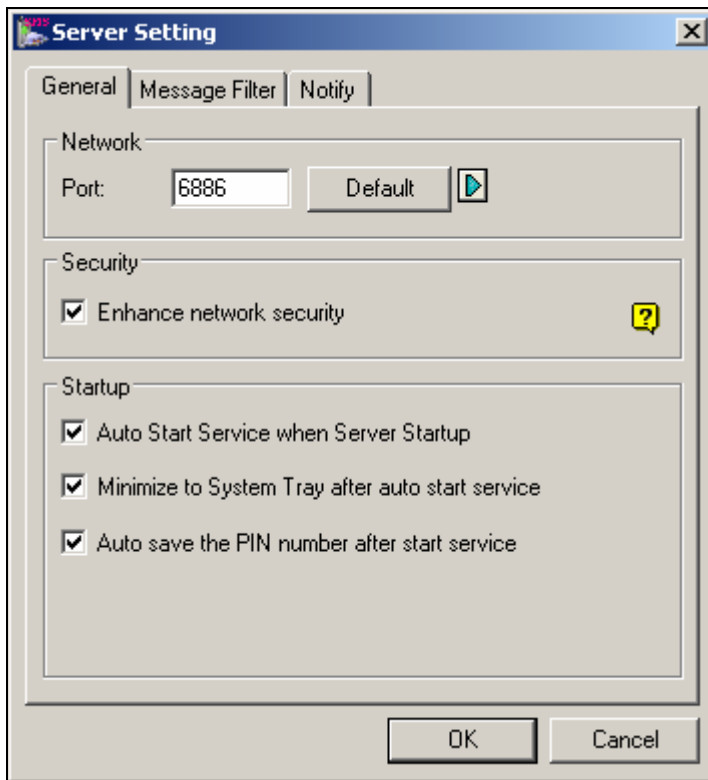

*Figure 9-3 Server Setting-General*

**[Network]** Define the port of the SMS Server, or leave it as default. To use UPnP for automatic port configuration to your router, click the **Arrow** button. For details, see *UPnP Settings* in Chapter 6.

**[Security]** Enable to apply enhanced Internet security. Please notice when the feature is enabled, the subscribers using earlier version than 8.0 cannot access the SMS Server anymore.

### [Startup]

- **Auto Start Service when Server Startup:** Automatically starts SMS services when the program starts.
- **Minimize to System Tray when auto start service:** Minimizes the SMS Server window to system tray when it starts.
- **Auto save the PIN number after start service:** Automatically saves the PIN number when SMS services start.

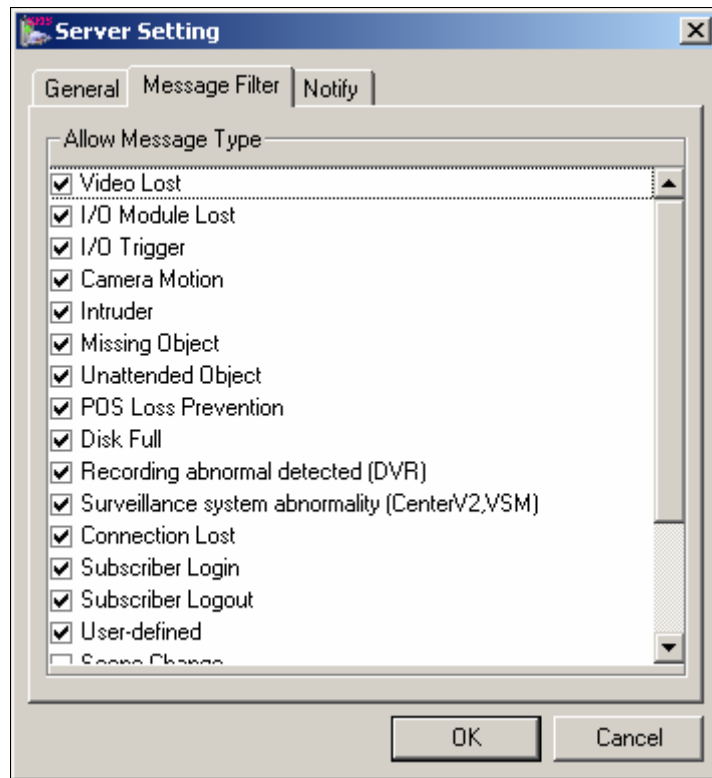
**[Message Filter]**

**Figure 9-4** Server Setting-Message Filter

Check the desired alert conditions to send SMS messages.

The **user-defined** condition refers to the SMS messages sent manually in Center V2 and VSM. See *Sending SMS* in Chapter 1 and Chapter 3 in the *CMS User's Manual*.

## [Notify]



**Figure 9-5** Server Setting-Notify

**[Check Internet Connectivity]** Assign any available IP address and click the **Test** button to know if your SMS Server can access Internet.

**[Send SMS notification when no connectivity]** Sends SMS notification to the three defined mobile numbers when the SMS Server cannot access Internet.

- **Mobile Icon:** Check the icon and define the number for the SMS notification. Up to three recipients can receive the SMS simultaneously.



## Account Settings

Click the **Account Setting** button (No.3, Figure 9-1) to display the following window.

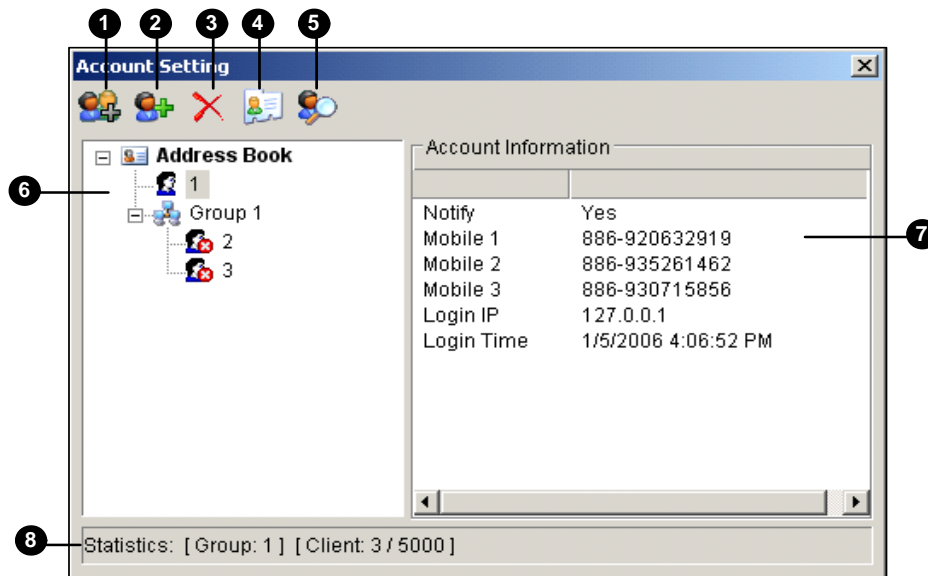

**Figure 9-6** Account Setting

The controls in the Account Setting window:

No.	Name	Description
1	Add A Group	Creates a group.
2	Add A Client	Creates a client.
3	Delete A Group/Client	Deletes a created group or client.
4	View/Edit A Client	Highlight one client and click the button to view or edit its information.
5	Find A Client	Searches a client.
6	Address Book	Lists the created groups and clients.
7	Account Information	Displays the highlighted client's account information.
8	Statistics	Displays the number of created groups and clients. The SMS Server can serve up to 5000 clients at one time.

## Creating a client:

1. Click the Add A Client button (No. 2, Figure 9-6). This dialog box appears.

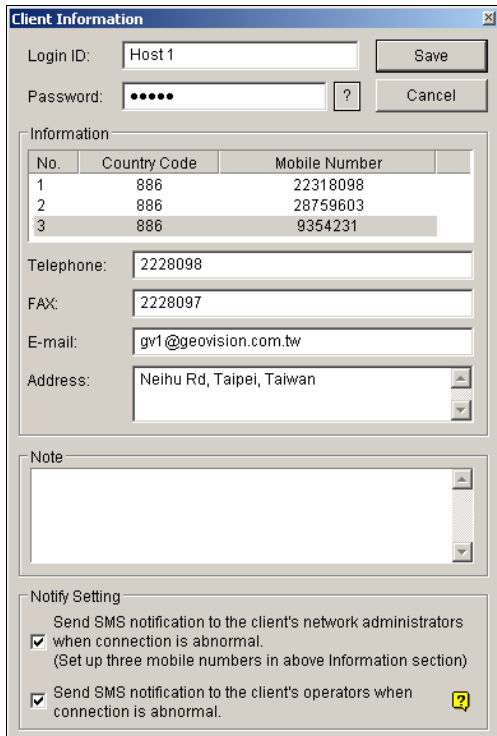

The dialog box titled "Client Information" contains the following fields and sections:

- Login ID:** Host 1
- Password:** [masked]
- Buttons:** Save, Cancel
- Information Section:**

No.	Country Code	Mobile Number
1	886	22318098
2	886	28759603
3	886	9354231
- Telephone:** 2228098
- FAX:** 2228097
- E-mail:** gv1@geovision.com.tw
- Address:** Neihu Rd, Taipei, Taiwan
- Note:** [Empty text area]
- Notify Setting:**
  - Send SMS notification to the client's network administrators when connection is abnormal. (Set up three mobile numbers in above Information section)
  - Send SMS notification to the client's operators when connection is abnormal. 

**Figure 9-7** Client Information

2. Type a login ID and password. They will be the ID and password for the client to log in the SMS Server (Figure 9-11).
3. In the Information section, type the client's related information.  
You can specify three mobile numbers of the client's network administrators for SMS notification.
4. In the Notify Setting section, you can send a SMS to the client in the case of:
  - Internet disconnection between the client and the SMS Server, or
  - Improper program shutdown in the client.

The recipients can be:

  - The client's network administrators: define three mobile numbers in above Information section.
  - The client's operators: See *Setting Mobile Numbers*, later in this chapter. For the users of Dispatch Server and Vital Sign Monitor, refer to the *CMS User's Manual*. Clicking the **Question** mark can view the specified mobile numbers at the client site.
5. Click **Save** for above settings.

## Disabling a client:

You can disable subscription services to an individual client when subscription expires.

In the Account Settings window (Figure 9-6), right-click the desired client and then select **Disable**.

To restore the service, right-click the desired client and then select **Enable**.

# SMS Log

## Setting SMS Log

Click the **SMS Log Setting** button in the SMS Server window (No. 2, Figure 9-1), and select **SMSLog Setting** to display the following dialog box.

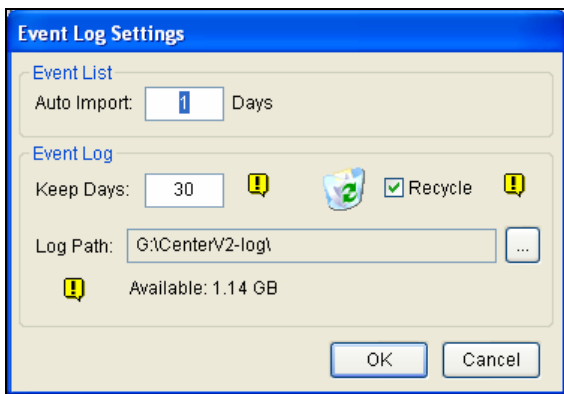

Figure 9-8

[Event List] Specify the number of days to be loaded when Event Log Browser is launched.

### [Event Log]

- **Keep Days:** Enter the number of days to keep log files.
- **Recycle:** Delete the files of the oldest day when storage space is lower than 500MB.
- **Log Path:** Click the [...] button to assign a storage path.

## Viewing SMS Log

Click the **SMS Log Setting** button in the SMS Server window (No. 2, Figure 9-1), and select **View SMSLog** to display the SMS Log Browser.

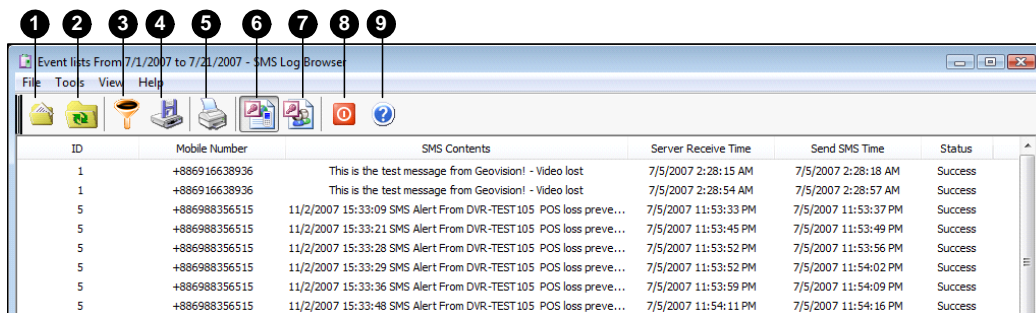

Figure 9-9

The buttons on the Event Log Browser:

No.	Name	Description
1	Open	Opens an event log.
2	Reload	Refreshes the event log manually
3	Filter	Defines the search criteria.
4	Backup	Exports the current event list and video files.
5	Print	Prints the current event list.
6	SMS Event Log	Displays the log of SMS server events.
7	System Event Log	Displays the log of SMS server activities.
8	Exit	Exits the browser.
9	About	Displays the application information of SMS Log Browser.

## SMS Event Log

Clicking the **SMS Event Log** button (No. 6, Figure 9-9) on the toolbar, you can monitor senders (ID), mobile numbers, text messages, sent and failed SMS. **This can be beneficial as you may charge your clients by the amount of SMS messages they sent.**

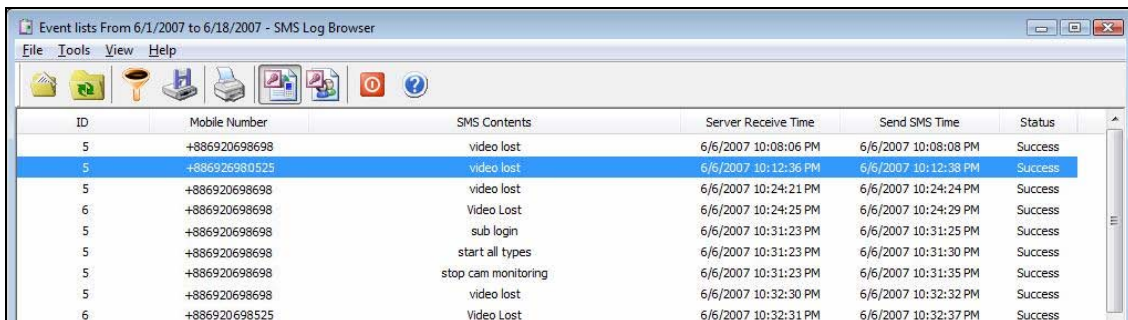

ID	Mobile Number	SMS Contents	Server Receive Time	Send SMS Time	Status
5	+886920698698	video lost	6/6/2007 10:08:06 PM	6/6/2007 10:08:08 PM	Success
5	+886926980525	video lost	6/6/2007 10:12:36 PM	6/6/2007 10:12:38 PM	Success
5	+886920698698	video lost	6/6/2007 10:24:21 PM	6/6/2007 10:24:24 PM	Success
6	+886920698698	Video Lost	6/6/2007 10:24:25 PM	6/6/2007 10:24:29 PM	Success
5	+886920698698	sub login	6/6/2007 10:31:23 PM	6/6/2007 10:31:25 PM	Success
5	+886920698698	start all types	6/6/2007 10:31:23 PM	6/6/2007 10:31:30 PM	Success
5	+886920698698	stop cam monitoring	6/6/2007 10:31:23 PM	6/6/2007 10:31:35 PM	Success
5	+886920698698	video lost	6/6/2007 10:32:30 PM	6/6/2007 10:32:32 PM	Success
6	+886920698525	Video Lost	6/6/2007 10:32:31 PM	6/6/2007 10:32:37 PM	Success

Figure 9-10

## System Event Log

Clicking the **System Event Log** button (No. 7, Figure 9-9) on the toolbar, you can monitor the server activities, client login and logout, and connection problems.

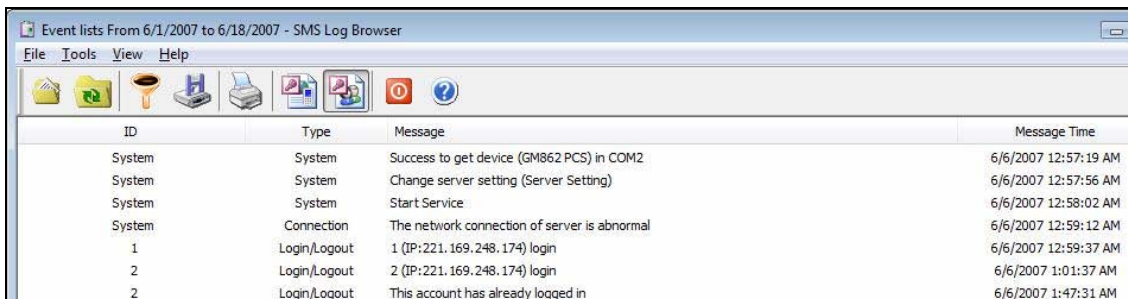

ID	Type	Message	Message Time
System	System	Success to get device (GM862 PCS) in COM2	6/6/2007 12:57:19 AM
System	System	Change server setting (Server Setting)	6/6/2007 12:57:56 AM
System	System	Start Service	6/6/2007 12:58:02 AM
System	Connection	The network connection of server is abnormal	6/6/2007 12:59:12 AM
1	Login/Logout	1 (IP:221.169.248.174) login	6/6/2007 12:59:37 AM
2	Login/Logout	2 (IP:221.169.248.174) login	6/6/2007 1:01:37 AM
2	Login/Logout	This account has already logged in	6/6/2007 1:47:31 AM

Figure 9-11

## Password Security

To prevent unauthorized users from changing your settings, set up an administrator password. To apply the password security, follow these steps:

1. Click the **Exit** button (No. 6, Figure 9-1), and then select **Change Password** to set a password.
2. Click the **Exit** button, and select **Logout Administrator** to lock the SMS Server window.
3. When you want to log in, click the **Exit** button and select **Login as Administrator**. A valid password is required.

## Connecting GV-System to SMS Server

To connect the GV-System to the SMS Server, follow these steps:

1. In the Main System, click the **Configure** button, point to **General Setting**, and then select **System Configure** to display the System Configure window.
2. In the Send Alerts Approach section, click the right arrow button to display this dialog box.

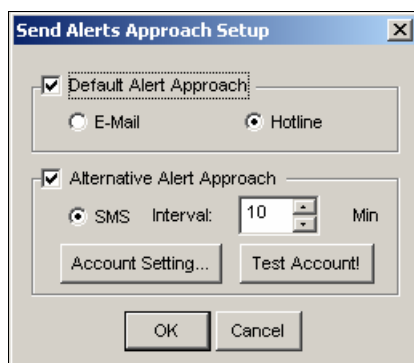

**Figure 9-12** Send Alerts Approach Setup

3. Check the **Alternative Alert Approach** item to enable other options.
4. Specify the Interval of two sent-out messages. The Interval time can be set up to 1440 minutes. Any alert condition will be ignored by the system during the interval.

5. Click the **Account Setting** button to display the following window.

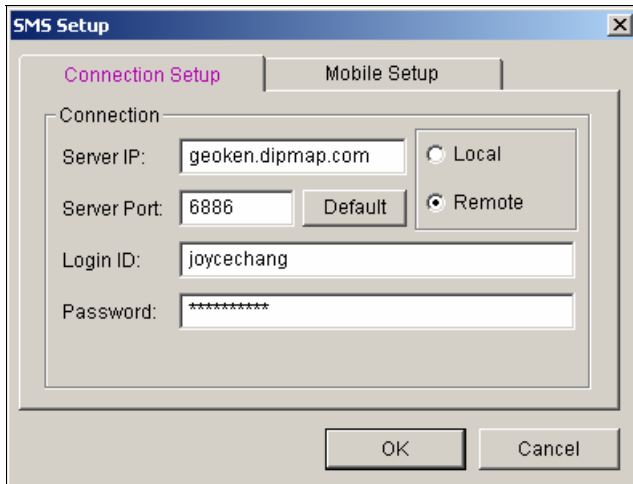

**Figure 9-13** SMS Setup- Connection Setup

- **Server IP:** Enter the IP address of the SMS Server.
  - **Server Port:** Enter the server port of the SMS Server, or keep it as default.
  - **Login ID & Password:** Enter a valid ID and password registered in the SMS Server (Figure 9-7).
  - **Local:** If the GSM/GPRS modem is installed at the same server with the GV-System, select this item.
  - **Remote:** If the GSM/GPRS modem is installed at a separate server, select this item.
6. Click **OK** to apply above settings.
  7. Click the **Test Account** button (Figure 9-12). If the connection of both devices is established, the message will appear: *Login SMS Server OK!* If the connection fails, the message will appear: *Connect to SMS Server Fail.*

## Setting Mobile Numbers

The Main System allows you to configure three mobile phone numbers for the SMS service. When an alert condition happens, the SMS messages will be sent out to the three assigned mobile phones simultaneously.

1. Open the **Send Alerts Approach Setup** dialog box (Figure 9-12).
2. Click the **Account Setting** button. This displays the SMS Setup dialog box (Figure 9-13).
3. Click the **Mobile Setup** tab in the upper of the window. The following dialog box appears.

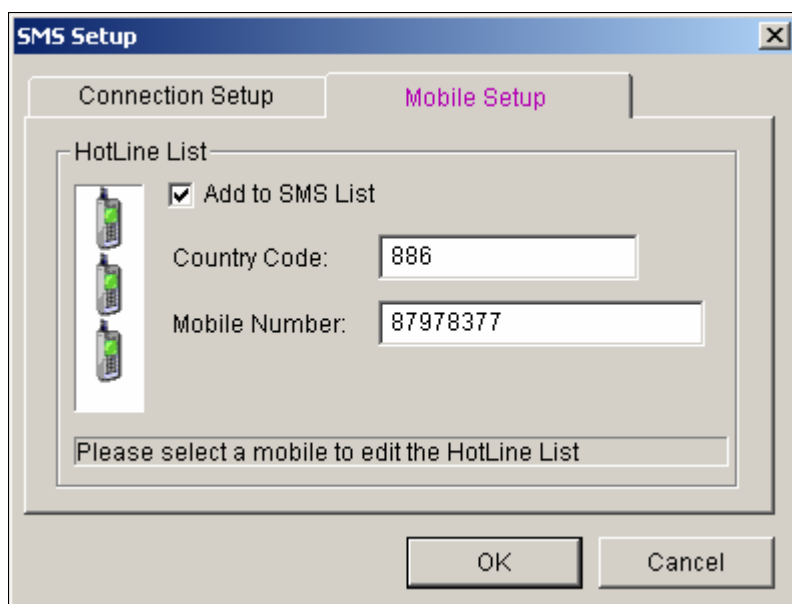

**Figure 9-14** SMS Setup- Mobile Setup

4. Click one mobile phone icon, and then check the **Add to SMS List** item for the mobile phone setup.
5. Type Country Code and Mobile Number.
6. Click other mobile phone icons, and follow step 4 and 5 to set up the rest of two mobile phone numbers separately.
7. Click **OK** to apply above settings.

---

**Note:** To configure an alert condition of sending out SMS messages, see *Send Event Alerts* in Chapter 1 for details.

---

# Chapter 10

---

<b>Useful Utilities .....</b>	<b>352</b>
<b>Dynamic DNS .....</b>	<b>352</b>
Installing Dynamic DNS.....	352
Registering Domain Name with DDNS.....	353
<b>Starting Dynamic DNS.....</b>	<b>355</b>
<b>TwinDVR System.....</b>	<b>356</b>
Starting TwinServer.....	358
Installing TwinDVR.....	360
Starting TwinDVR.....	360
TwinDVR Settings.....	363
<b>Watermark Viewer .....</b>	<b>364</b>
<b>Twin View Display .....</b>	<b>366</b>
<b>Windows Lockup .....</b>	<b>368</b>
The GV-Desktop Screen.....	368
GV-Desktop Features .....	369
<b>Token File for Save Mode.....</b>	<b>372</b>
<b>Authentication Server.....</b>	<b>373</b>
Installing the Server .....	373
The Server Window .....	373
Creating a DVR List.....	375
Editing a User .....	376
Starting the Server .....	377
Connecting GV-System to the Server.....	378
Backup Servers .....	380
Remote Access from Control Center, Remote E-Map and MultiView .....	381
<b>Fast Backup and Restore.....</b>	<b>384</b>
Installing the FBR Program .....	384
Running the FBR Program .....	384
Selecting a Skin .....	385
Customizing the Features.....	386
Backing up and Restoring Settings .....	387
<b>Hot-Swap Recording.....</b>	<b>389</b>
The Media Man Tool Window .....	390
Viewing Disk Drive Status.....	391



Adding a Disk Drive .....	393
Removing a Disk Drive .....	394
Auto Logging In and Minimizing Media Man Tools Window .....	395
Setting Up LED Panel.....	396
<b>Backup Server .....</b>	<b>398</b>
Usage Requirement.....	398
Connecting to the Storage System .....	399
Advanced Settings.....	400
Manually Adding Files for Backup .....	403
Viewing Server Status.....	404
Retrieving Recorded Files .....	407
<b>Backup Viewer .....</b>	<b>408</b>
Usage Requirements .....	408
Installing Backup Viewer.....	408
Starting Backup Viewer.....	409
Performing Queries.....	410
Viewing the Event Files .....	410
Using Remote ViewLog .....	412
<b>Bandwidth Control Application .....</b>	<b>413</b>
Running the Bandwidth Control.....	414
Allowing Remote Control at DVR .....	415
Connecting to a WebCam Server.....	415
Controlling a WebCam Server .....	416
Bandwidth Setup.....	417
Block List Setup .....	418
General Setup.....	419
<b>Report Generator .....</b>	<b>420</b>
Starting Report Generator .....	420
Setting Up Report Generator .....	420
Setting Up Report Criteria .....	422
E-Mail Attachment Settings .....	425
Playing Back the Video Recording .....	426
Viewing Event Log .....	426

## Useful Utilities

This chapter discusses some advanced level features and utilities that could help administrator to maximize system performance in a security network.

### Dynamic DNS

The Dynamic DNS is an application that allows users to register domain names that always point to their GV-Systems. This application is only necessary when your GV-System is using a dynamic IP address. If so, the DDNS will update GV-System's IP address to DNS Server every 10 minutes. Therefore, even if your GV-System's IP address changes, you can still locate it by using the registered domain name.

Dynamic DNS supports Windows XP, Windows 2000, Windows Server 2003 and Windows Vista, but it does not support Windows 95/98 or ME.

Dynamic DNS uploads IP addresses over the Internet through ports 80 and 81. If your GV-System is connected behind a router or firewall, make sure ports 80 and 81 are enabled. Dynamic DNS will only upload global IP addresses. If your GV-System is using virtual IP, NAT port mapping should be done first.

### Installing Dynamic DNS

To install Dynamic DNS, follow these steps:

1. Insert the Surveillance System Software CD to your PC. It will automatically run, and a window appears.
2. Select the **Install V 8.2.0.0 System** item.
3. Select **Dynamic DNS Service**, and follow the on-screen instructions.

## Registering Domain Name with DDNS

1. Go to Windows **Start**, point to **Programs**, select **DDNS**, and then run **Dynamic DNS Service**. The DNS Client dialog box (Figure 10-3) appears. Click **Register**. The following Dynamic DNS register page appears.
2. Type a username in the Username field. Username can be up to 16 characters. Username will accept “a ~ z”, “0~9”, and “-”, but will not accept space or “-” as the first character.
3. Enter a password in the Password field. Passwords are case-sensitive and must be at least 6 characters. Re-enter the password in the Re-Type password field for confirmation.
4. In the Word Verification section, type the code within the box. In this example, the code you should enter is 4NCXRC. Word verification is not case-sensitive.

# DynamicDNS 01

---

**Register**

Username:

Password:

Re-type Password:

**Username**

Username is 16-character maximum; username may not start with spaces or minus signs ('-'). Username will be your hostname.

**Password**

The password is case-sensitive.

---

Enter the characters as they are shown in the box below.



**Word Verification**

This step helps us prevent automated registrations.

---

Figure 10-1

5. Click the **Send** button, and the system will display the following message if the registration is completed successfully.



**Figure 10-2**

- **Username:** The username you registered. In this example the username is “swansea”
- **Hostname:** The hostname you created. Hostname is made by registered username and “dipmap.com”. In this example the host name is “http://swansea.dipmap.com”. This will be the domain name you use for login to GV-System.
- **IP Address:** Your GV-System’s current IP address. This IP address will be updated every 10 minutes.

---

**Note:** Before you register a domain name with Dynamic DNS Service provided by GeoVision, you must run any GeoVision application in the background if the installed GV-System is of version 8.2 or later.

---

## Starting Dynamic DNS

To start Dynamic DNS, run **Dynamic DNS Service** from the Windows Start menu. This DNS Client dialog box appears

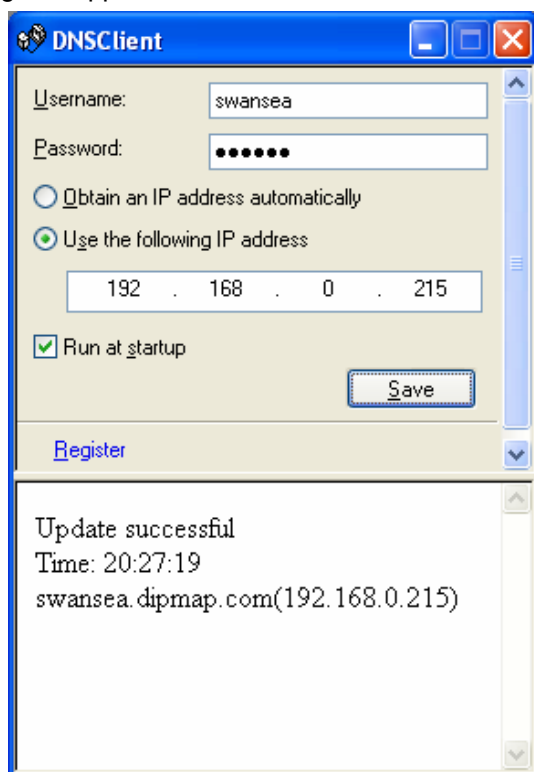

*Figure 10-3*

- **Username:** Type the username used to enable the service from the DDNS.
- **Password:** Type the password used to enable the service from the DDNS.
- **Obtain an IP address automatically:** The DDNS server will use any available IP address from the system or the router.
- **Use the following IP address:** If your system or router has more one IP address, you can assign one IP address for the communication between the DDNS server and GV-System. It is highly suggested to assign the fixed IP address. If the assigned IP address is dynamic, the DDNS will not be able to access your system when the IP address is changed.
- **Run at startup:** Select this option to automatically run the DDNS service at Windows startup.
- **Save:** After above settings, click this button. The connection information will be displayed.

---

**Note:** The DNS Client will not upload IP address unless one of the following applications is running: Main System, Center V2, VSM, Dispatch Server, Twin DVR, and SMS Server. If the IP address of your GV-System is not updated for more than 30 days, your host name will be deleted automatically.

---

## TwinDVR System

TwinServer is an external application that helps sharing the networking liability from the GV-System. A complete TwinServer concept requires at least two computers: a TwinServer, which should be run on the computer where GV-System is installed, and a TwinDVR, which should be run on a separate computer connected to the same LAN as the TwinServer. The TwinServer sends video stream to TwinDVR, while TwinDVR acts as a WebCam Server and serves all WebCam clients over the Internet. One TwinDVR can serve approximately 200 channels over the Internet. Multiple TwinDVRs can be added to the network as online traffic increases.

There are two ways to connect TwinServer and TwinDVR: TCP/IP mode and Multicast mode. Both have its advantages and disadvantages; choose the one that suits your application mostly.

### TCP/IP Mode

TCP/IP is a simpler and cost-effective solution. In the TCP/IP mode, the TwinServer and TwinDVRs are connected in a point-to-point connection. It means that video streams are sent from TwinServer to TwinDVR-A, then TwinDVR-A duplicates the video streams and sends them to TwinDVR-B. If the connection between TwinServer and TwinDVR-A is broken, TwinDVR-B will not be able to receive video streams as well.

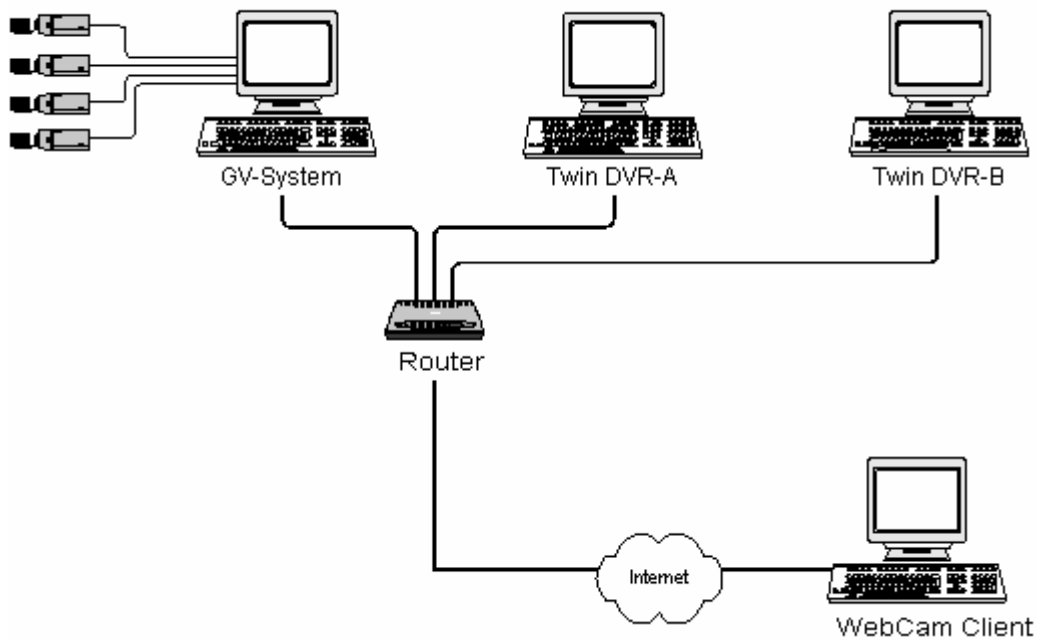

Figure 10-4

## MultiCast Mode

Multicast Network is more complicated and expensive to setup. In the Multicast mode, the TwinServer transmits video streams in packets to a virtual buffer of the Multicast network. The virtual buffer then broadcasts the video streams to all TwinDVRs under the network. Each TwinDVR should be installed with two network cards. One is for the hub where TwinServer is plugged in, and the other for a DSL or ISDN modem with dedicated ISP service to the Internet. Each TwinDVR serves its own group of WebCam Clients.

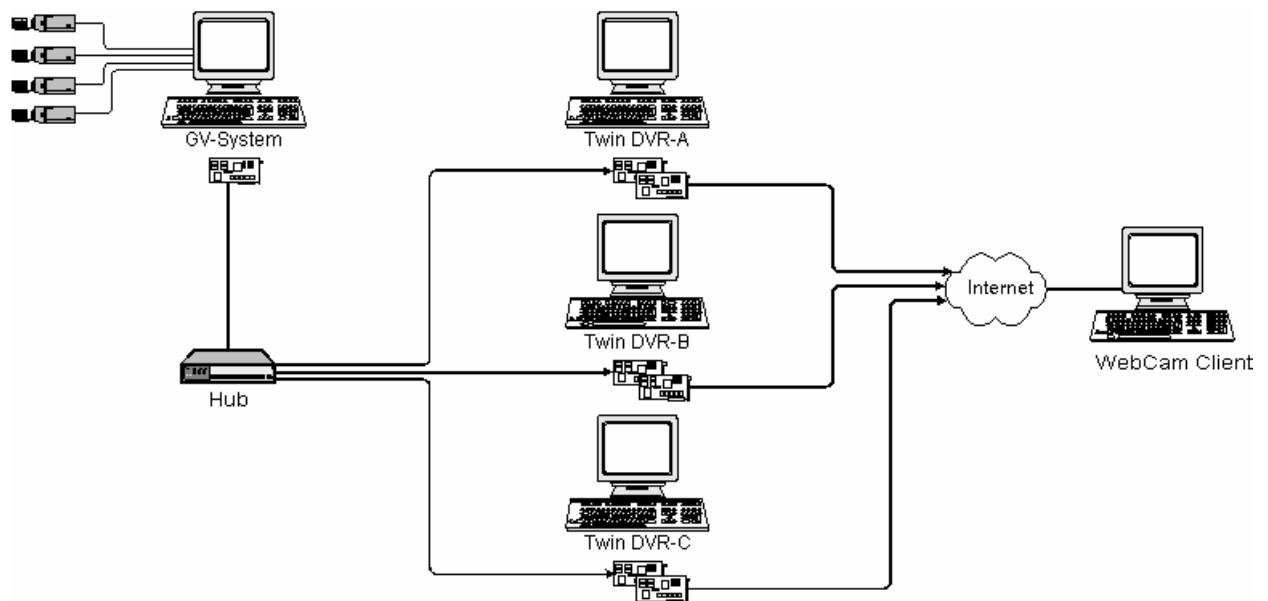
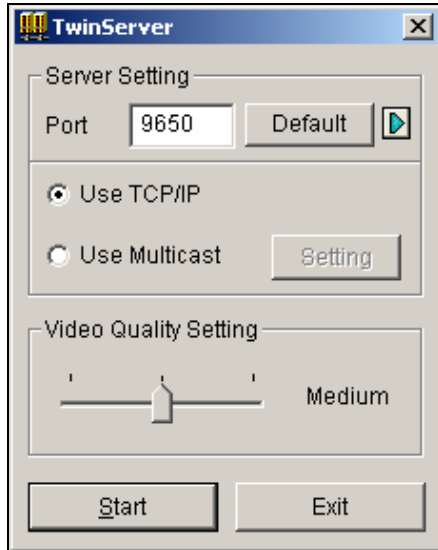

Figure 10-5

## Starting TwinServer

1. In the Main System, click the **Network** button, and then select **TwinServer**. This TwinServer setup dialog box appears.

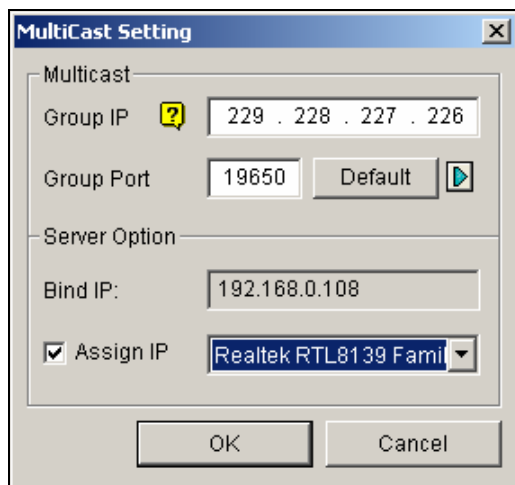

**Figure 10-6** TwinServer Settings

2. The default port 9650 is for video transmission. Keep it as default or modify it if necessary. Using UPnP for automatic port configuration to your router, click the **Arrow** button. For details, see *UPnP Settings* in Chapter 6.
3. Select the type of network to be used: **Use TCP/IP** or **Use Multicast**. If **Use Multicast** is enabled, click the **Setting** button to display the Multicast Setting dialog box. See *Multicast Settings* below.
4. Use the **Video Quality Setting** slider to adjust video quality for Low, Med, or High.
5. Click the **Start** button to activate the TwinServer.



## Multicast Settings



**Figure 10-7** MultiCast Settings

### [MultiCast]

- **Group IP:** Displays the IP address for the virtual buffer that stores the video streams in Multicast network.
- **Group Port:** Used for transferring video streams over the Multicast network. To enable the UPnP function, click the **Arrow** button. For details, see *UPnP Settings* in Chapter 6.

**[Server Option]** Only necessary if more than one network card is installed in your GV-System.

Select **Assign IP** and select one network card. This will automatically bring up Blind IP of the network card.

## Installing TwinDVR

The TwinDVR is included in the Surveillance System Software CD. This application should be installed in a separate PC within the same Local Area Network as the TwinServer. Before installation, make sure your PC meets the following minimum system requirements:

OS	Windows 2000, XP, Server2003, Vista
CPU	Pentium 4, 2.0 GHz
Memory	256 MB RAM
Hard Disk	40 GB
VGA	NVIDIA GeForce II 32 MB
Network	TCP/IP

1. Insert the Surveillance System Software CD to the PC where TwinDVR will be installed. It runs automatically, and a window appears.
2. Select the **Install V 8.2.0.0 System** item.
3. Click **TwinDVR System**, and follow the on-screen instructions.  
During the installation, you may be prompted to install GeoMPEG4 codec; simply click **Yes**.

## Starting TwinDVR

1. Run **TwinDVR.exe**. The TwinDVR dialog box appears.

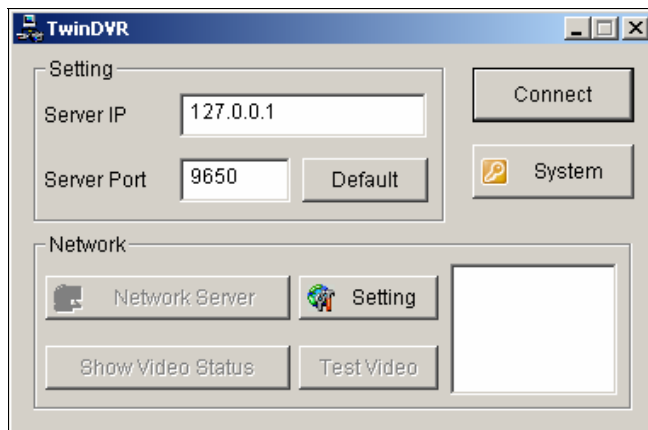

**Figure 10-8** TwinDVR Setup

2. Type the IP address of TwinServer in the Server IP field.
3. Keep the server port in default, or it should match the TwinServer port. See Figure 10-6.
4. Click the **Connect** button to establish the connection between TwinDVR and TwinServer. A valid user ID and password are required.

If the connection is established, the **Network Server**, **Show Video Status**, and **Test Video** buttons will be available. You can now use them to set up TwinDVR for:

- Testing Video Stream
- Starting WebCam Server at TwinDVR
- Setting Multiple TwinDVRs in TCP/IP Mode
- Setting Multiple TwinDVRs in Multicast Mode

### Testing Video Stream

This function allows you to test the video transmission between TwinServer and TwinDVR. Click the **Show Video Status** button to display 16 monitoring windows beneath the TwinDVR dialog box. Click the **Test Video** button and video streams from the connected TwinServer will be streamed to the monitoring windows for 10 seconds. You may click the **Hide Video Status** button to close the monitoring windows.

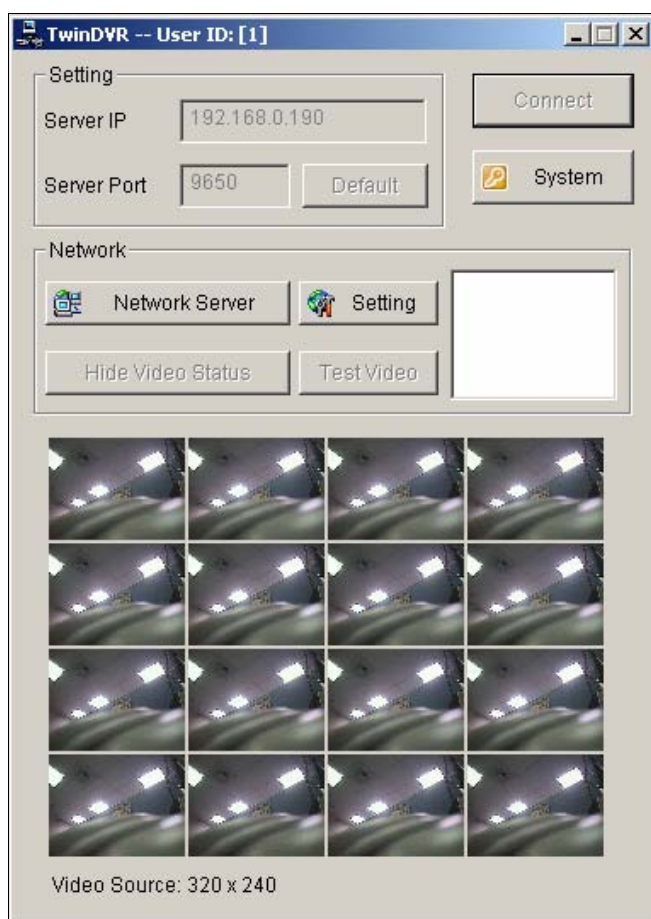

*Figure 10-9 Testing Video Stream*

### **Starting WebCam Server at TwinDVR**

Click the **Network Server** button, and then select **WebCam Server** to display the Server Setup dialog box (Figure 6-1).

### **Setting Multiple TwinDVRs in TCP/IP Mode**

Click the **Network Server** button, and then select **Extended Server**. The Extended Server is to duplicate TwinServer's video stream and transmit it to the next TwinDVR in the same network. If there are five TwinDVRs in the network, you should activate the **Extended Server** function in TwinDVR 1, 2, 3, and 4 respectively. It's not necessary to activate TwinDVR 5 since there are no more TwinDVR running behind it.

### **Setting Multiple TwinDVRs in Multicast Mode**

Click the **Network Server** button, and then select **Use Multicast Mode**. The Multicast mode is now activated. The Multicast Server is to instruct TwinDVR to obtain video streams from the virtual buffer. If there are five TwinDVRs connected to the network, all TwinDVRs will be required to select the **Use Multicast Mode** option.

## TwinDVR Settings

### Network Card Settings

In Figure 10-8, click the **Setting** button, and then select **Network Setting** to display the following dialog box. The Network Setting option is only necessary when your TwinDVR has more than one network card. Select **Assign IP** and select one network card. This will automatically bring up Bind IP of the network card. The network card will be used for connecting to TwinServer; the other network card will be assigned for connecting to Internet. If you want the TwinDVR to automatically reconnect to TwinServer, select **Retry until connected** and set the time interval.

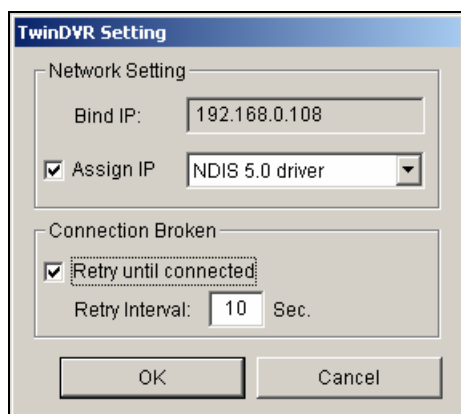

Figure 10-10 TwinDVR Setting

### System Settings

In Figure 10-8, click the **Setting** button, and then select **System Configure** to display the following dialog box. The option is only available when TwinDVR is connecting to TwinServer.

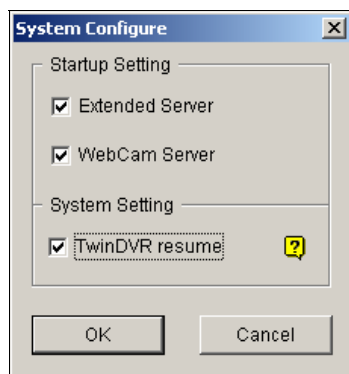

Figure 10-11 System Settings

#### [Startup Setting]

- **Extended Server:** Activates Extended Server on TwinDVR startup.
- **WebCam Server:** Activates WebCam Server on TwinDVR startup.

#### [System Setting]

- **TwinDVR resume:** Resumes TwinDVR connection when the system shuts down unexpectedly.

## Watermark Viewer

You can make a watermark proof to protect videos from unauthorized alteration or manipulation. In Main System, click the **Configure** button, select **System Configure**, and then select **Use Digital Watermark Protection** option. This allows all recorded videos to be marked with a permanent and inseparable image.

The watermark is invisible to naked eyes. In order to see it, the video stream must be open in a watermarking verification program by following these steps:

1. Go to the system folder, and locate **WMProof.exe**.

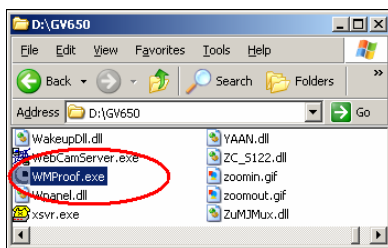

Figure 10-12

2. Double-click to open the program. This displays the following Watermark Viewer window.

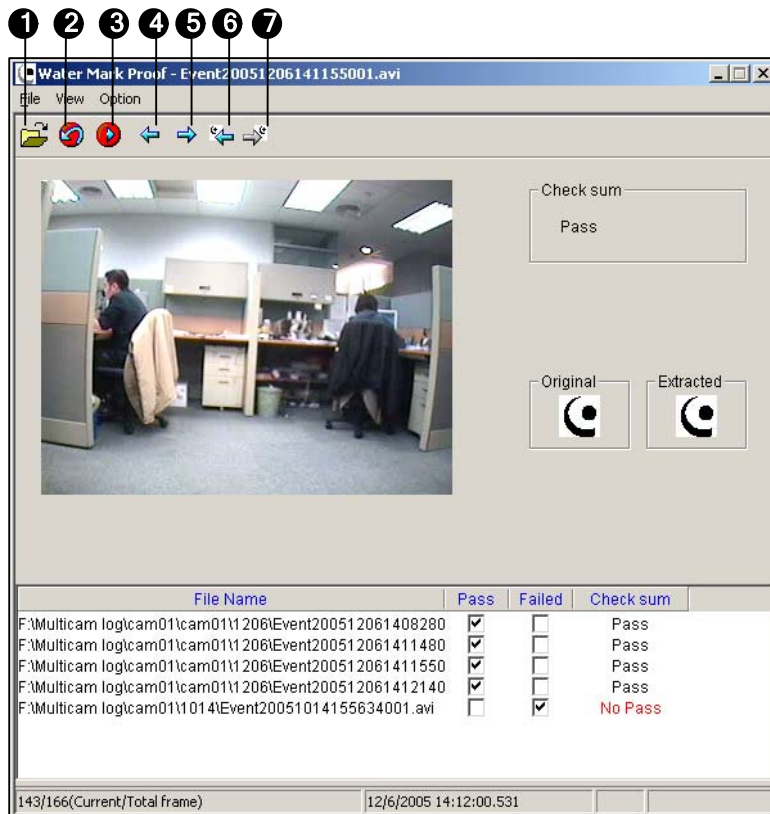

Figure 10-13

The controls in the window:

No.	Name	Description
1	Open File	Finds a video file to play.
2	First Frame	Goes to the first frame of the file.
3	Play	Plays the file.
4	Previous Frame	Goes to the previous frame of the file.
5	Next Frame	Goes to the next frame of the file.
6	Previous Watermarked Frame	Goes to the previous frame that contains watermark.
7	Next Watermarked Frame	Goes to the next frame that contains watermark.

The Watermark Viewer displays the verifying result as follows:

- **Check sum:** If the video stream has not been tampered, the Check Sum section displays a message: *Pass*. Otherwise a message: *No Pass* will appear.
  - **Original vs. Extracted:** The Extracted section should have the same icon displayed as that in the Original section. If not, it indicates the video may have been altered.
3. Click the **Open File** button (No.1, Figure 10-13), select a video file and click **Open**. The video file is then listed in the status field of the window. Also, you can drag multiple video files directly from storage folders to the status field.
  4. Highlight the file and double-click it to play.

## Twin View Display

You can display Main System and ViewLog in two separated monitors. To make this operation possible, your system must equip with VGA card having dual video outputs. Each output should be connected to its own monitor display.

1. Right-click on the Windows desktop and select **Properties**. This displays the Display Property dialog box.
2. Select **Settings**, enable **Extend my Windows desktop onto this Monitor**, and then click the **Apply** button.

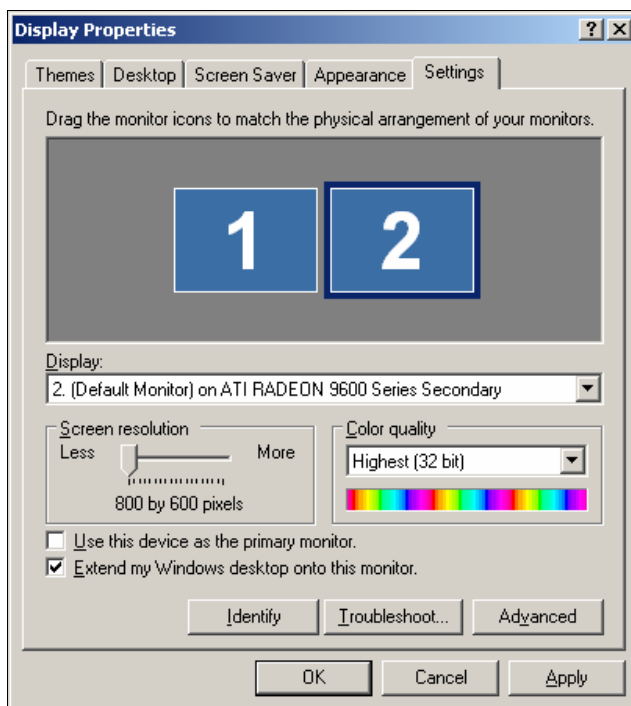

**Figure 10-14**

3. Go the system folder and locate **DMPOS.exe**.

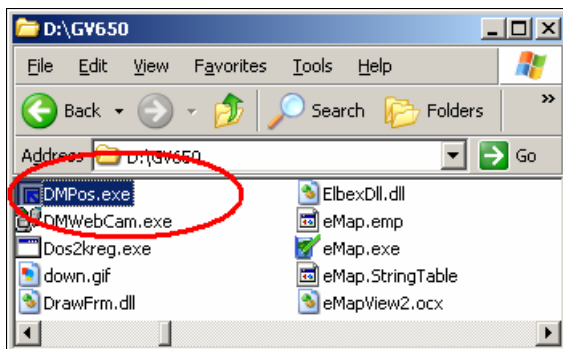

**Figure 10-15**



4. Double-click the program to display the Set Application Function Position window.

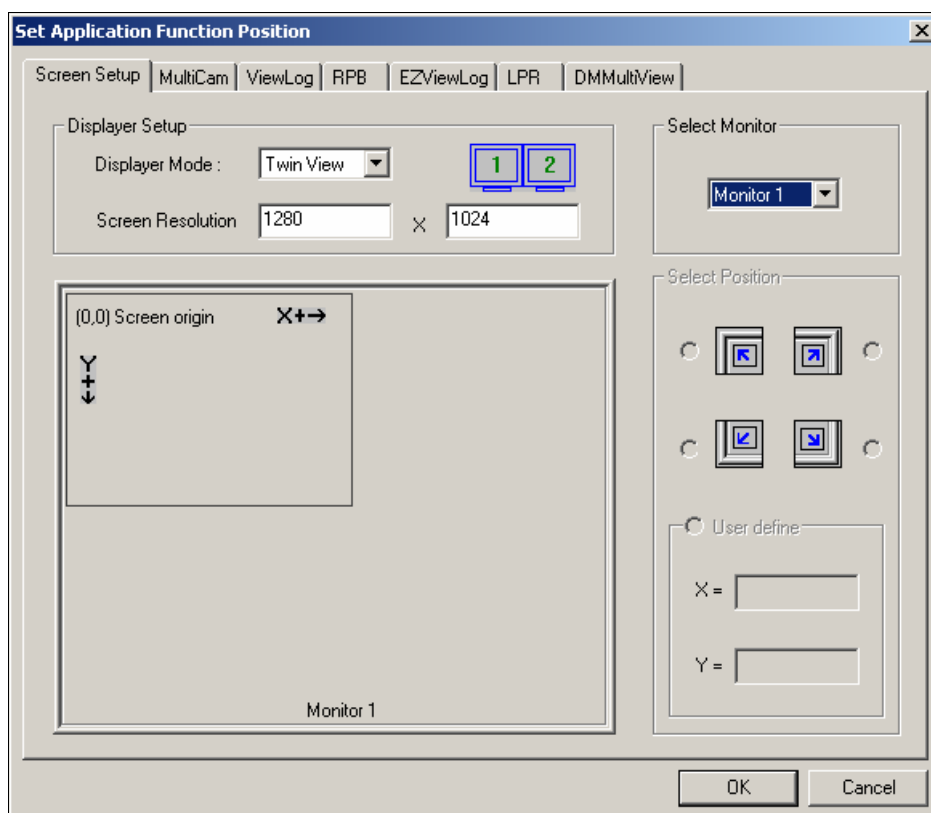

**Figure 10-16**

5. In the Screen Setup tab, select **TwinView** from the Displayer Mode drop-down list.
6. In the MultiCam tab, select **Monitor 1** from the Select Monitor drop-down list.
7. In the ViewLog tab, select **Monitor 2** from the Select Monitor drop-down list.
8. Click the **OK** button and start GV-System, which should appear in monitor 1.
9. Click the **ViewLog** button on the main screen and select **Video/Audio log** from the menu. ViewLog should appear in monitor 2.

---

**Note:** The **Select Position** option allows you to determine where to position GV-System on Windows. It is only necessary if your GV-System is set to 800x600 panel resolution but your Windows desktop is set to 1024x768 or higher. It is recommended that both GV-System and Windows desktop to be set to the same resolution. For details on how to set the resolution for GV-System, refer to *Panel Resolution* in Chapter 1.

---

## Windows Lockup

This feature helps you to secure your PC while away from your workstation. You may lock up the Windows desktop while launching a customized GV-Desktop. The GV-Desktop is where operators are limited to run the GV-System and the selected programs.

### The GV-Desktop Screen

The GV-Desktop program is included in the installation of Main System. Go to Windows **Start**, point to **Programs**, select GV folder, and click **Key Lock Utility**. This GV-Desktop screen appears.

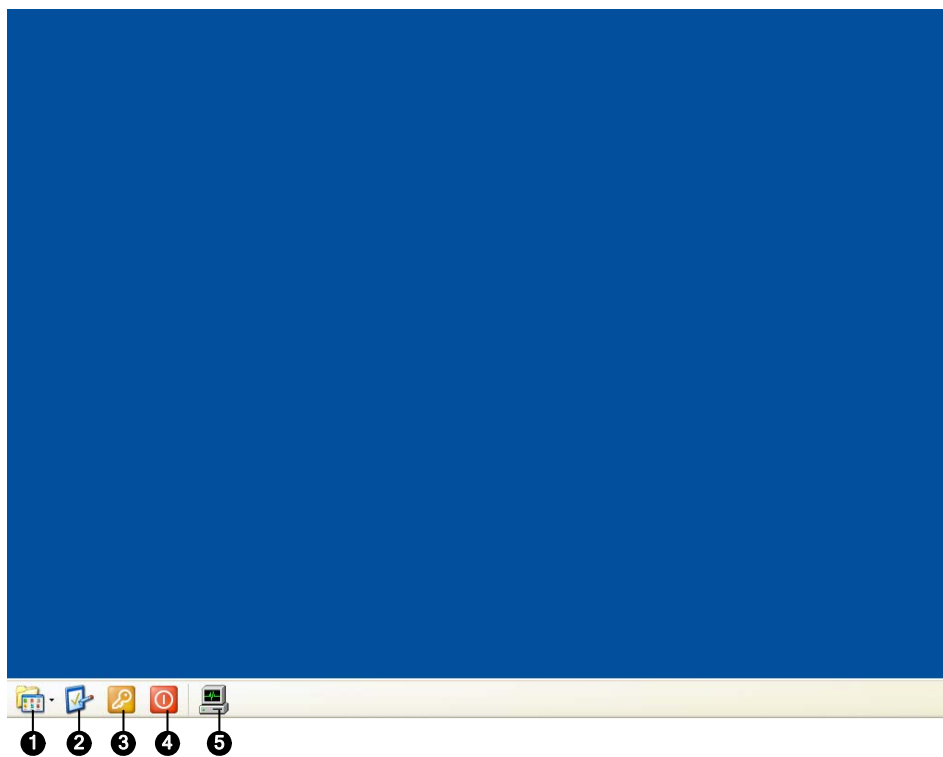

*Figure 10-17*

The controls in the GV-Desktop screen:

No.	Name	Description
1	Programs	Accesses programs.
2	Settings	Adds programs to the programs menu.
3	Log Off	Logs off GV-Desktop.
4	Shut Down	Shuts down the computer.
5	Task Manager	Click to view the tasks currently running on your computer.

## GV-Desktop Features

The five buttons on GV-Desktop are discussed below.

### Programs

Click the **Programs** button to see the program menu. The default programs are Multicam Surveillance System (Main System), ViewLog, Backup System, Repair Database Utility, Remote Playback Server, and eMap Editor. You can add or remove new programs to the menu. In the example below, Paint is a new program added to the menu.



**Figure 10-18**

## Settings

Click the **Settings** button to display the following window. A valid ID and password are required.

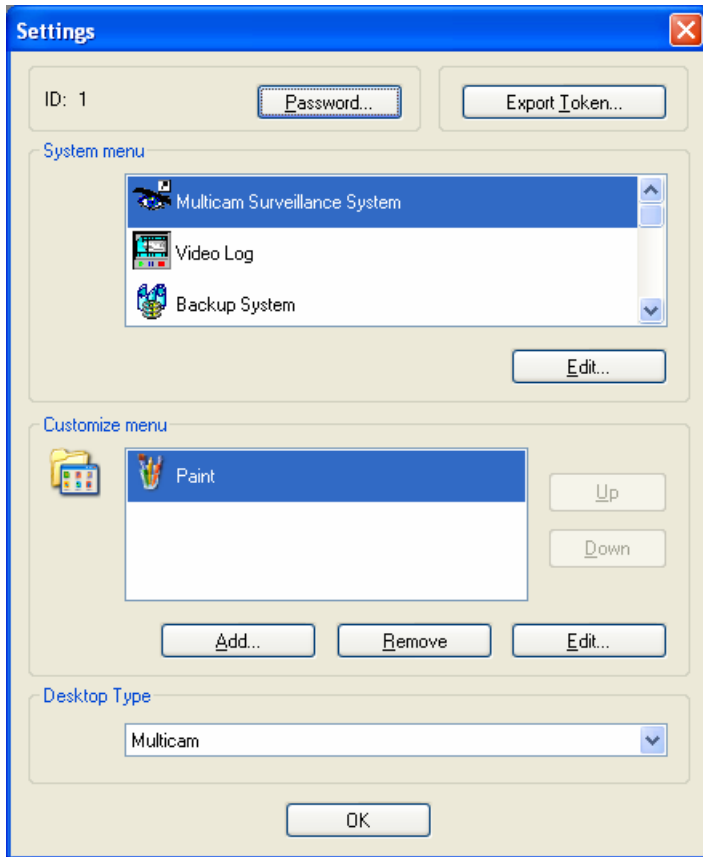

**Figure 10-19**

**[Password]** Click to change the password. For the option of Allow Removing Password System, see *Setting up Password* in Chapter 1.

**[Export Token]** This option is discussed in *Token File for Save Mode* later in this chapter.

**[System Menu]** The menu lets you rename system programs. Select a desired program and click the **Edit** button to change its name.

**[Customized Menu]** The menu lets you add other programs to the Programs menu. Click the **Add** button to display the following window. In the Target field, type a path or click the button next to the field to assign a path. Then enter the program name, comment, or even change an icon for the program. Finally, click **OK** to add the program.

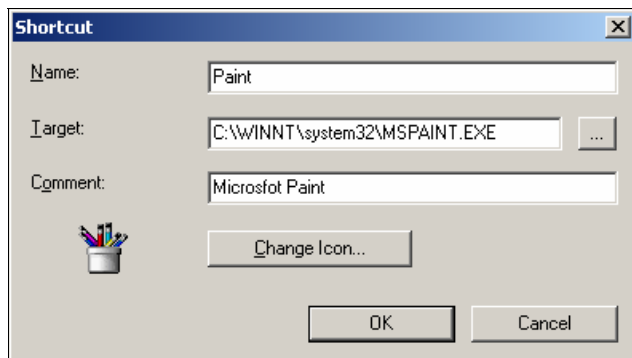

**Figure 10-20**

**[Desktop Type]** Select Windows or GV-Desktop (Multicam) from the drop-down menu. The selected desktop will launch the next time when you log in to PC.

## Log Off

Click the **Log off** button to log off GV-Desktop. A valid ID and password are required.

## Shut Down

Click the **Shut Down** button to shut down your computer. A valid ID and password are required.

## Task Manager

Click the **Task Manager** button to view the programs currently running on your computer. When you minimize a program, it will be hiding and working in the background. Double-click the program listed in Task Manger to bring the program back to desktop.

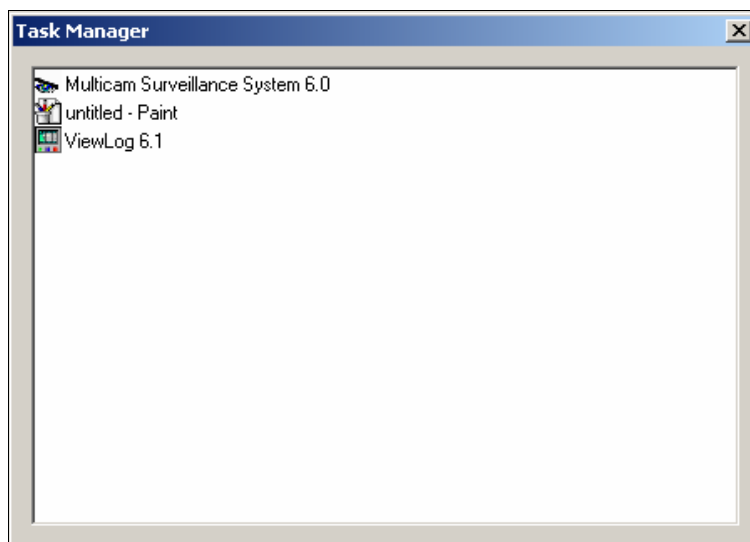

**Figure 10-21**

## Token File for Save Mode

This option in the Settings section lets you export a token file. In case you enter safe mode and are in the status of the GV-Desktop, this token file will let you exit from the GV-Desktop and enter the Windows desktop. To export a token file and apply it, follow the steps below.

1. Click the **Export Token** button (Figure 10-19) to display the following dialog box.



**Figure 10-22**

2. Type a code in the Token Code field.
3. Click **OK**. The Save As dialog box appears.

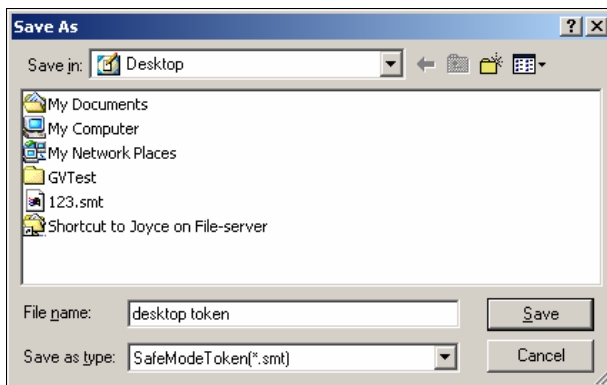

**Figure 10-23**

4. Locate a path, and enter a desired name in the File Name field.
5. Click **Save** to save the file.  
When you enter safe mode and are in the status of the GV-Desktop:
6. Click the **Settings** button on the desktop. You will be prompted to locate the stored token file and enter the set token code.
7. When the Settings window (Figure 10-19) appears, select **Windows** in the Desktop Type field, and then exit from the window.
8. Click the **Log Off** button to log off the GV-Desktop and enter the Windows desktop. The token code and file are also required here.

## Authentication Server

The Authentication Server allows a remote server to restrict access to the password settings of local GV-Systems. When the Server is working, the previous password settings in local GV-Systems will be invalid. Local GV-Systems will submit to the full control of the Server.

### Installing the Server

To install this application in a remote sever, follow these steps:

1. Insert the Surveillance System Software CD. It runs automatically, and a window appears.
2. Select the **Install V 8.2.0.0 System** item.
3. Click **Authentication Server**, and follow the on-screen instructions.

### The Server Window

Go to Windows **Start**, point to **Programs**, select **AuthServer**, and then click **AuthServer**. This window appears.

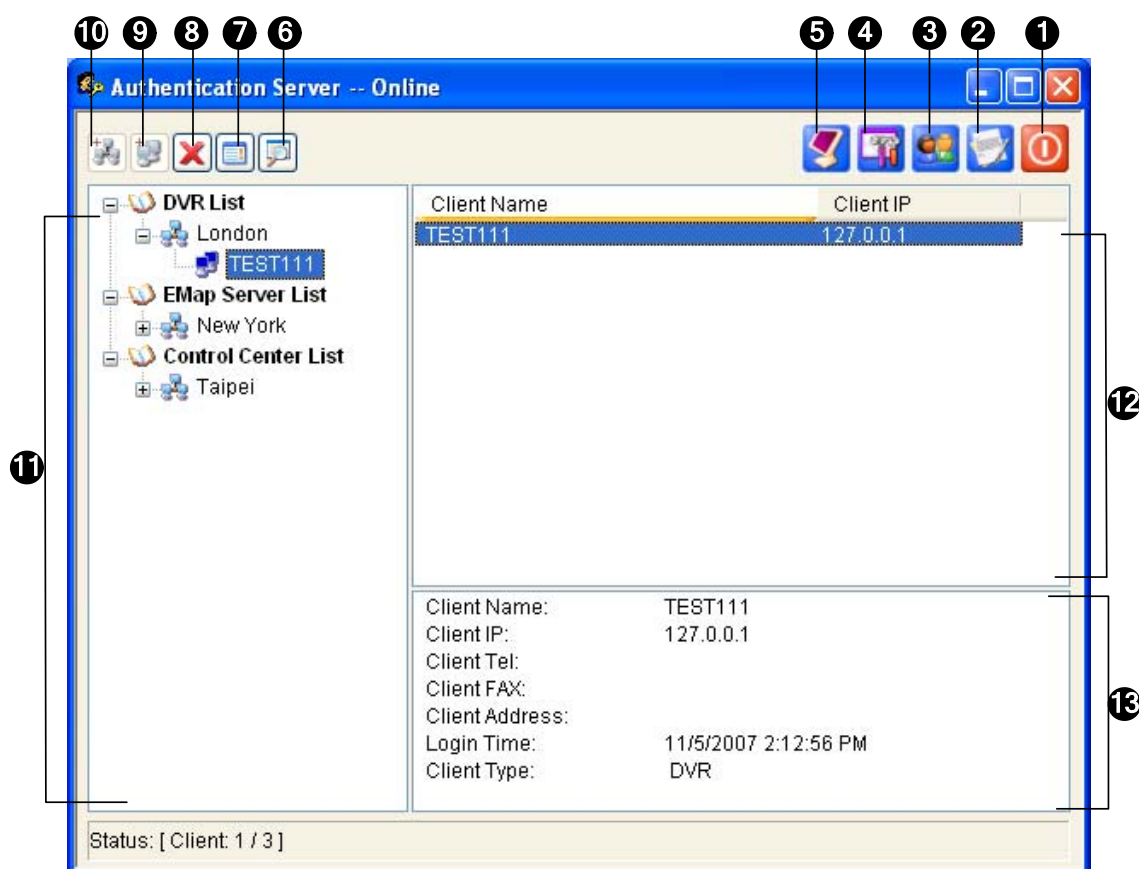

Figure 10-24 The Authentication Server Window

The controls in this window:

No.	Button	Description
1	Exit	Exits this window; Logs out Administrator; Changes Password, exports account information.
2	Log	Sets up the Authentication Server Log and opens the log browser.
3	Password Setup	Configures passwords and grants permissions to clients.
4	Server Setup	Configures the Authentication Server.
5	Start/Stop Service	Starts/Stops the Authentication Server.
6	Find A Client	Finds an existing client.
7	View/Edit A Client	Select a client from the Client List, and click to view /edit it.
8	Delete An Area /Client	Deletes an existing group or client.
9	Add A Client	Creates a client account.
10	Add An Area	Creates an Area group.
11	Client List	Lists the created clients and area groups.
12	Connected Client List	Lists the connected GV-Systems, E-Map Servers or Control Centers.
13	Client Information	Lists the information of the selected GV-System, E-Map Server or Control Center.



## Creating a DVR List

You can arrange your clients' GV-Systems into different groups for a better management. To create a DVR list, follow these steps:

1. To create a group, click the **Add An Area** button (No.10, Figure 10-24).
2. To create a client under the group, click the **Add A Client** button (No.9, Figure 10-24). This displays the Client Information dialog box.

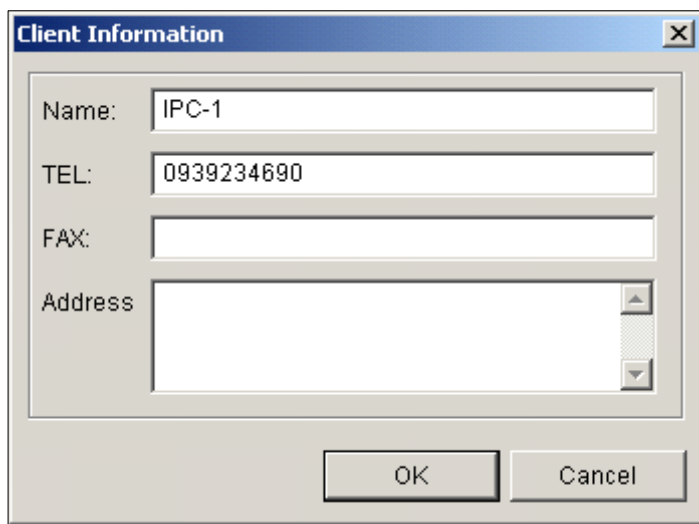
A screenshot of a 'Client Information' dialog box. The dialog has a title bar with the text 'Client Information' and a close button (X). Inside the dialog, there are four input fields: 'Name:' with the value 'IPC-1', 'TEL:' with the value '0939234690', 'FAX:' which is empty, and 'Address' which is empty. At the bottom of the dialog, there are two buttons: 'OK' and 'Cancel'.

*Figure 10-25 Client Information*

3. Type the client's information. The Name must match that of local GV-System.
4. Click **OK**.

## Editing a User

The Authentication Server operator can create users; can grant, deny, or modify permissions; and can allow access to local GV-Systems listed in the DVR list.

1. Click the **Password Setup** button (No.3, Figure 10-24) to display the Password Setup window. The window is the same as the Password Setup window in Main System, except the following section.

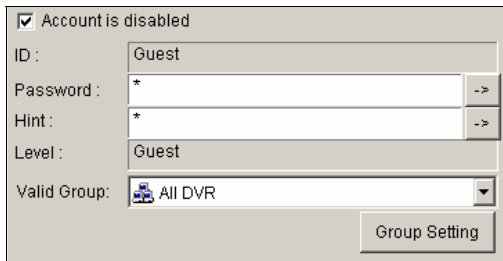

The Password Setup window includes the following fields and controls:

- Account is disabled
- ID: Guest
- Password: \* [ ] ->
- Hint: \* [ ] ->
- Level: Guest
- Valid Group: All DVR (dropdown menu)
- Group Setting button

**Figure 10-26** Password Setup

2. To create and edit a user, refer to *Setting up Password* in Chapter 1.
3. To grant the user access to local DVRs:
  - a. Click the **Group Setting** button in the window. The Valid Group List window appears.
  - b. Click the **New Group** button. The DVR Group Information window appears.
  - c. Give a DVR group name, and select the desired DVRs into the group.
  - d. Go back to the Password Setup window. Use the Valid Group drop-down list to select the created DVR group.

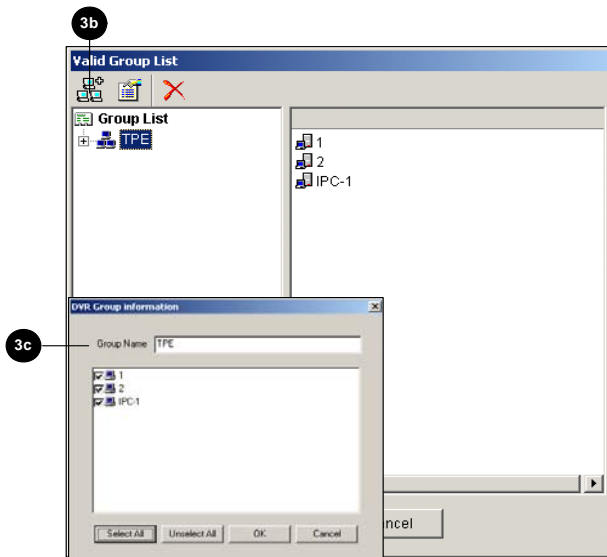

**Figure 10-27** Valid Group List and DVR Group Information

---

**Note:** In the Password Setup window of Authentication Server, the **Fast Backup & Restore** tab is not available.

---

## Starting the Server

To configure the server and start the service, follow these steps:

1. Click the **Server Setup** button (No. 4, Figure 10-24). This dialog box appears.

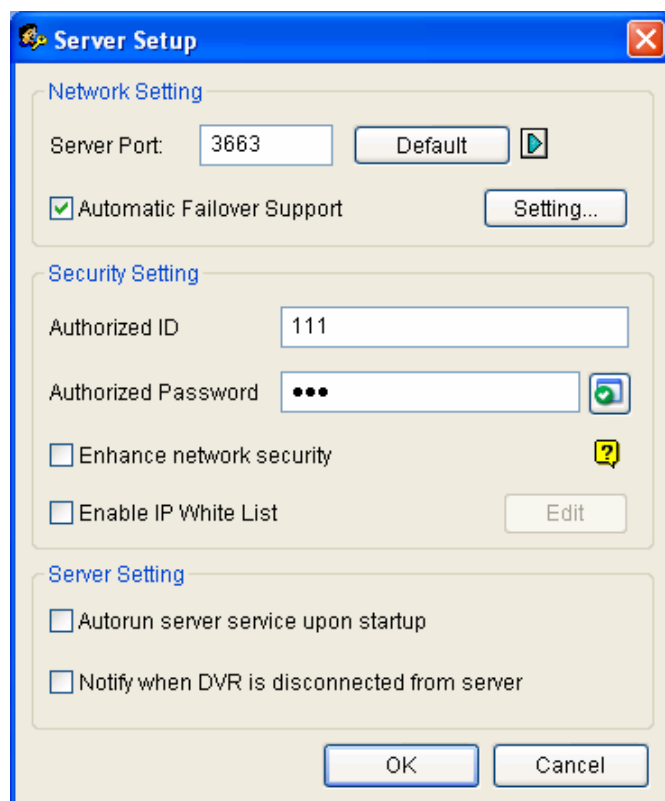

**Figure 10-28** Sever Setup

**[Network Setting]** The default port number is 3663. Using UPnP for automatic port configuration to your router, click the **Arrow** button. For details, see *UPnP Settings* in Chapter 6.

**[Authorized ID and Password]** The ID and password entered will be those for the local DVRs to log in the server.

- **Enhance network security:** Enable to enhance network security on Authentication Server.
- **Enable IP White List:** Create a list of IP addresses allowed to connect to Authentication Server. For details, see *IP White List Settings* in Chapter 6.

### **[Server Setting]**

- **Auto start service when server startup:** Starts automatically the service when Windows starts.
- **Notify when DVR disconnected from server:** Notifies the Authentication Server with a pop-up window when the DVR and server loss connection.

2. Click **OK** to apply above settings.
3. Click the **Start/Stop Service** button (No. 5, Figure 10-24) to start the connection.

## Connecting GV-System to the Server

To configure the GV-System in order to access the Authentication Server remotely through a network connection, follow these steps:

1. Click the **Configure** button, point to **General Setting**, select **Password Setup**, and then select **Remote Authentication Setup**. This dialog box appears.

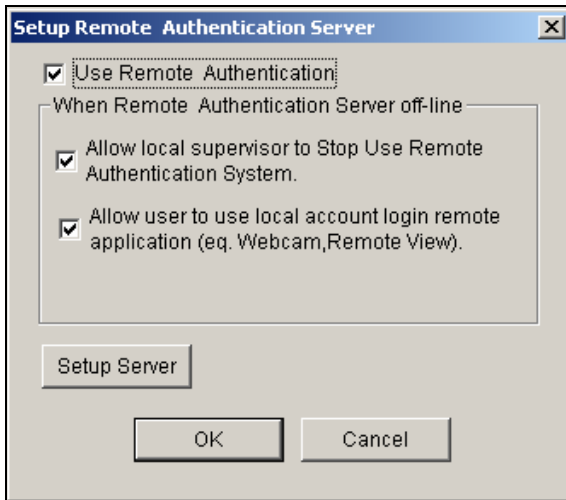

*Figure 10-29 Setup Remote Authenticator Server*

- **Use Remote Authenticator:** Enable the connection with the Authentication Server.
- **Allow Local supervisor to stop use remote authentic system:** Allows the local supervisor to stop the Authentication application when the connection fails. If the option is disabled and the connection fails, the dialog box won't be accessible until connection resumes.
- **Allow user to use local account login remote application:** Allows the local users to access other remote applications with their previous password and ID settings when the connection fails.

2. Click the **Setup Server** button in Figure 10-29. This dialog box appears.

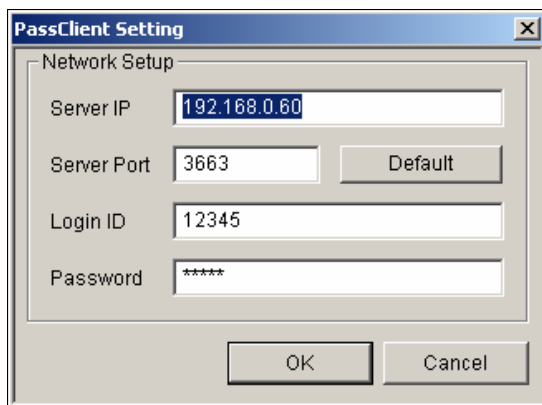

*Figure 10-30 PassClient Setting*

3. Enter the IP address and port of the Authentication Server. Enter the valid ID and password created in the Authentication Server (Figure 10-28).
4. Click **OK** to start the connection. **When the connection is established, the previous password settings in the GV-System will be invalid.**
5. Press **[L]** on the keyboard to call up the Login dialog box. The icon  indicates the connection is established.



**Figure 10-31**

6. Type a valid User ID and password for login.

As long as the Authentication sever is working, every time when you start the GV-System, the Login dialog box will appear.

---

**Note:** When the disconnection icon  appears, there might be three reasons:

1. The valid ID and password created in the Authentication Server (Figure 10-28) don't match those in the GV-System (Figure 10-31).
  2. The client's given name (Figure 10-25) doesn't match the GV-System's.
  3. The network media has traffic problem.
-

## Backup Servers

You can configure up to two backup servers in case of the primary server failure. Whenever the primary fails, the backup server takes over the connection from clients, providing uninterrupted services.

1. Import the clients' accounts from the primary server to the backup server.
2. On the Authentication Server window, click the **Server Setup** button. The Server Setup dialog box (Figure 10-32) appears.
3. Select the **Automatic Failover Support** option, and click the **Setting** button. This Automatic Failover Support dialog box appears.
4. Click the **Add** button. The Automatic Failover Setup dialog box (Figure 10-32) appears.
5. Type the IP address of the backup server. Keep the default port setting or modify it if necessary.
6. Type the Authorized ID and Authorized Password matching to those of the Security Setting in the Server Setup dialog box. If the information is inconsistent, the connection to the backup server cannot be established.

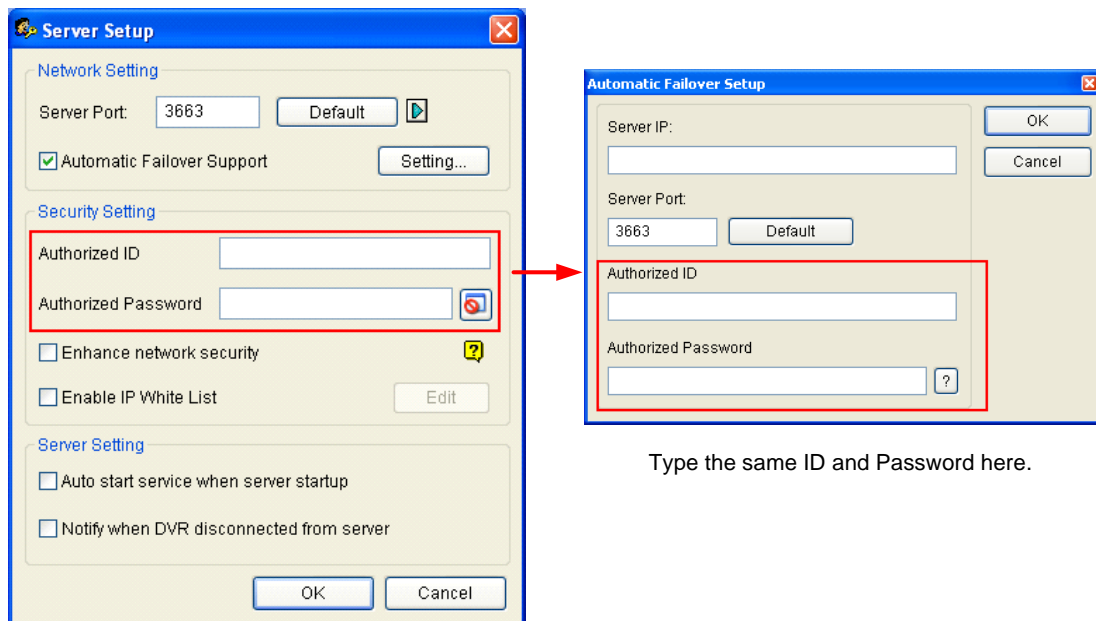

**Figure 10-32**

---

**Note:** Once the primary server is ready to resume the services, it is required to close the backup server so the connection from clients can move back to the primary.

---

## Remote Access from Control Center, Remote E-Map and MultiView

Instead of connecting to DVR hosts directly, the user of E-Map Server, Control Center and MultiView can establish the connection to the Authentication Server, and therefore obtain account settings created there to control the assigned DVR hosts and cameras. In other words, this connection can restrict access to specific DVR hosts and cameras by user account created on the Authentication Server.

When the connection to the Authentication Server is established, the user of E-Map Server, Control Center and MultiView must use a valid user ID and Password created on the Authentication Server for login. Once the user log in the E-Map Server, Control Center or MultiView, a list of assigned DVR hosts to the user account will be displayed, and the user can only view the assigned camera.

### Setting Authentication Server

In the Authentication Server window (Figure 10-24), right-click **E-Map Server List** or **Control Center List**, and then select **Add A Client**. Type the name and information of this added E-Map Server or Control Center in the Client Information dialog box.

### Accessing from E-Map Server

To access from the E-Map Server using the Authentication Server account settings, follow these steps:

1. In the E-Map Server window, click **Tools** on the menu bar, and select **Options**. This dialog box appears

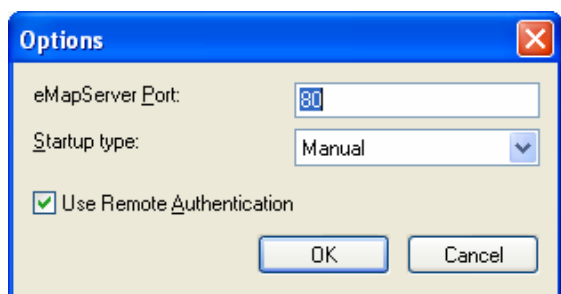

**Figure 10-33**

2. Select **Use Remote Authentication**. If you want the Authentication Server service started automatically at Windows startup, select **Automatic**. Keep the Port 80 as default or change it if necessary. Click **OK**.

3. Click **Tools** on the menu bar, and select **Remote Authentication**. This dialog box appears.

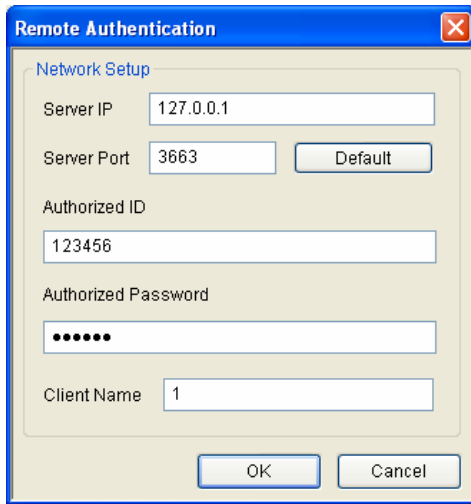

**Figure 10-34**

4. Type the IP address, authorized ID and authorized password of the Authentication Server. Type the client name created on the Authentication Server. Click **OK**.
5. Click the **Start Service** button on the toolbar to start the E-Map Server.
6. When you log in the E-Map Server, enter the user ID and password created on the Authentication Server. A list of assigned DVR hosts to the user will be displayed.

## Accessing from Control Center

To access from Control Center using the Authentication Server account settings, follow these steps:

1. On the Host List, right-click **Host List by ID** and select **Remote Authentication Setup**. A dialog box appears. See Figure 10-34.
2. Type the IP address, authorized ID and authorized password of the Authentication Server. Type the client name created on the Authentication Server. Click **OK** to enable connecting to the Authentication Server.
3. To access the Authentication Server account settings, on the Host List, right-click **Host List by ID** and select **Get Host List by ID**. A dialog box prompts you for ID and password.
4. Type a user ID and password created on the Authentication Server, and click **OK**. A list of assigned DVR hosts to the user will be displayed.



### Accessing from MultiView

When you log in the MultiView, enter a user ID and password created on the Authentication Server. A list of assigned DVR hosts to the user will be displayed.

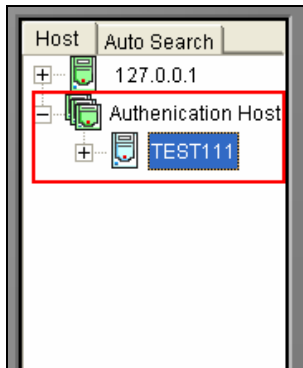

**Figure10-35**

## Fast Backup and Restore

With the Fast Backup and Restore (FBR) solution, you can change interface skin and customize features to suit personal preference, as well as back up and restore your configurations in Main System.

### Installing the FBR Program

1. Insert the Surveillance System Software CD. It will run automatically, and a window appears.
2. Select the **Install V 8.2.0.0 System** item.
3. Click **Fast Backup & Restore Multicam System**, and follow the on-screen instructions.

### Running the FBR Program

Run **Fast Backup & Restore main System** from the Start menu. This window will appear.

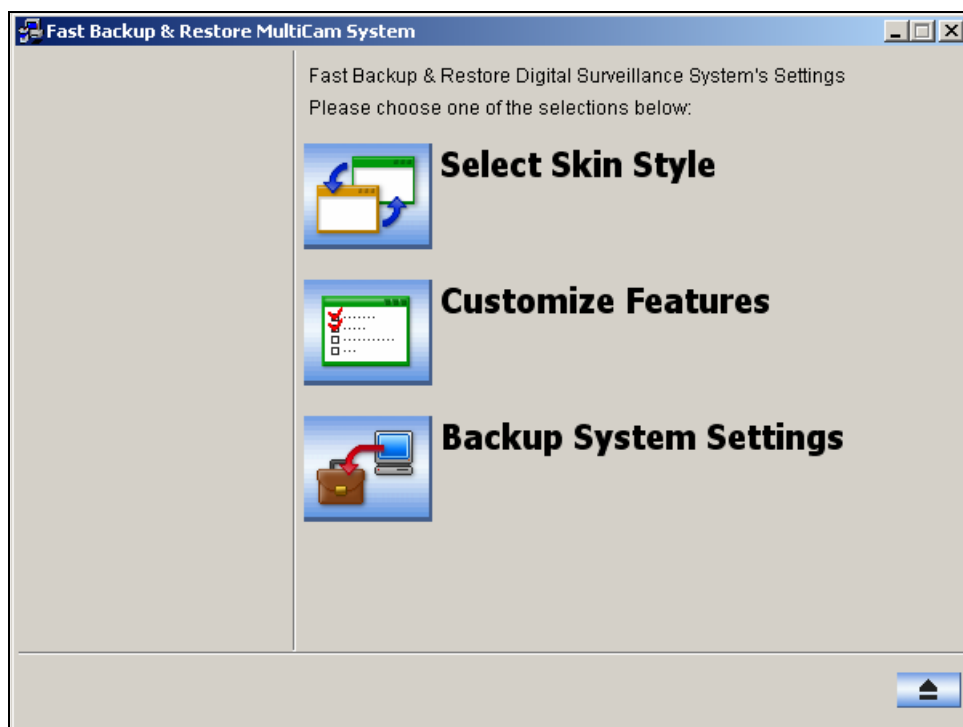

*Figure 10-36 FBR Window*

## Selecting a Skin

The GV-System provides two skin options: silver (default) and conventional. The skin change will only apply to the screens of Main System, ViewLog and remote applications. The dialog boxes won't be affected.

You can also change the screen image of startup splash, non-active video and video lost.

### Changing the Skin Style

1. In the FBR window (Figure 10-36), click the **Select Skin Style** icon. The option menu appears.
2. To use one skin style for all applications, simply select **All use Conventional Style** or **All use Silver Style**.

To change the skin style of a single application, point to the desired application, and then select the skin style you want to apply.

3. Close the FBR window, and start the GV-System to see the change.

### Customizing the Screen Images

You can replace the screen images of Startup Splash, Non-Active Video and Video Lost with your own.

Before you start, remember that each screen image has its specified size. Create your own image according to these specifications:

- **Startup Splash:** Bit Depth 24, Width 319, and Height 272.
- **Non-Active Video:** Bit Depth 24, Width 720, and Height 576.
- **Video Lost:** Bit Depth 24, Width 270, and Height 576.

To customize the screen image, follow these steps:

1. In the FBR window (Figure 10-36), click the **Select Skin Style** icon, point to **DVR**, and then select **Custom Logo**. This window appears.

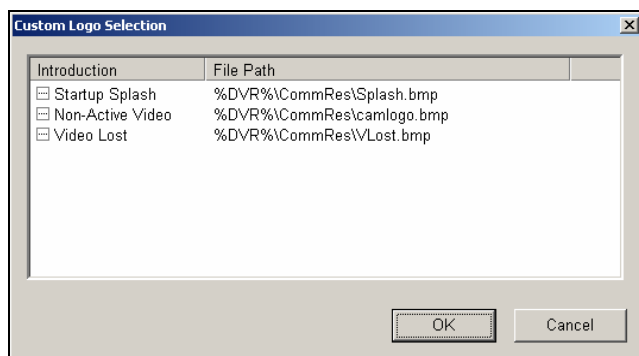

**Figure 10-37**

2. Click a desired screen image to be replaced with an imported image.
3. Exit the FBR program, and start the GV-System to see the change.

## Customizing the Features

Not every feature may be of equal interest to you. You can now specify which features are to be displayed at system startup.

1. In the FBR Window (Figure 10-36), click the **Customize Features** icon to display this dialog box.

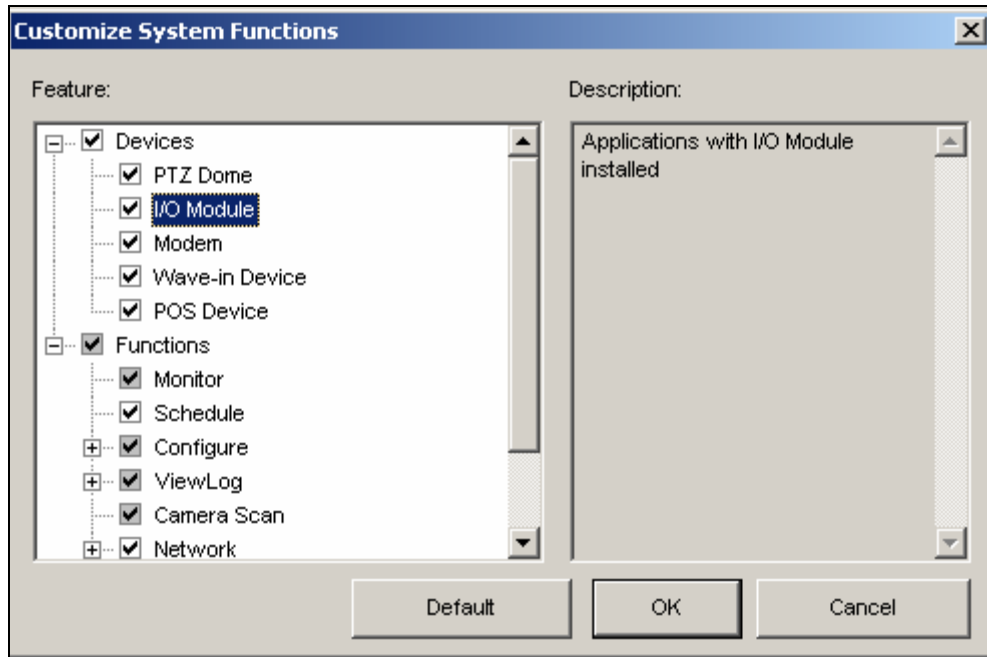

**Figure 10-38**

**[Devices]** Expand this folder, and select the device applications you want to enable in the GV-System.

**[Functions]** Expand this folder, and select the functions you want to enable in the GV-System. The gray checked boxes indicate that the functions are enabled by default. No changes can be made to these functions.

2. Click **OK** to apply the settings.

## Remote Access from Control Center, Remote E-Map and MultiView

Instead of connecting to DVR hosts directly, the user of E-Map Server, Control Center and MultiView can establish the connection to the Authentication Server, and therefore obtain account settings created there to control the assigned DVR hosts and cameras. In other words, this connection can restrict access to specific DVR hosts and cameras by user account created on the Authentication Server.

When the connection to the Authentication Server is established, the user of E-Map Server, Control Center and MultiView must use a valid user ID and Password created on the Authentication Server for login. Once the user log in the E-Map Server, Control Center or MultiView, a list of assigned DVR hosts to the user account will be displayed, and the user can only view the assigned camera.

### Setting Authentication Server

In the Authentication Server window (Figure 10-24), right-click **E-Map Server List** or **Control Center List**, and then select **Add A Client**. Type the name and information of this added E-Map Server or Control Center in the Client Information dialog box.

### Accessing from E-Map Server

To access from the E-Map Server using the Authentication Server account settings, follow these steps:

1. In the E-Map Server window, click **Tools** on the menu bar, and select **Options**. This dialog box appears

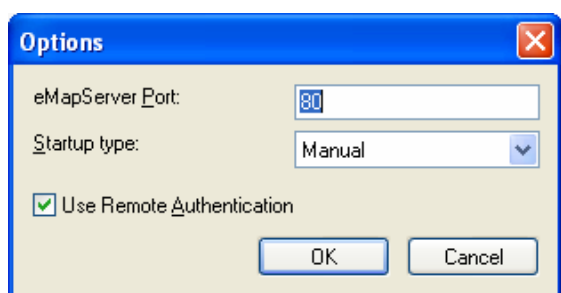

**Figure 10-33**

2. Select **Use Remote Authentication**. If you want the Authentication Server service started automatically at Windows startup, select **Automatic**. Keep the Port 80 as default or change it if necessary. Click **OK**.

## Restoring the System

You can restore the current system with the backup of configuration file. Also, you can copy this backup file to configure another system with the same settings as the current system.

1. Open the backup file (\*.exe) you previously stored. A valid ID and password are required to display this window.

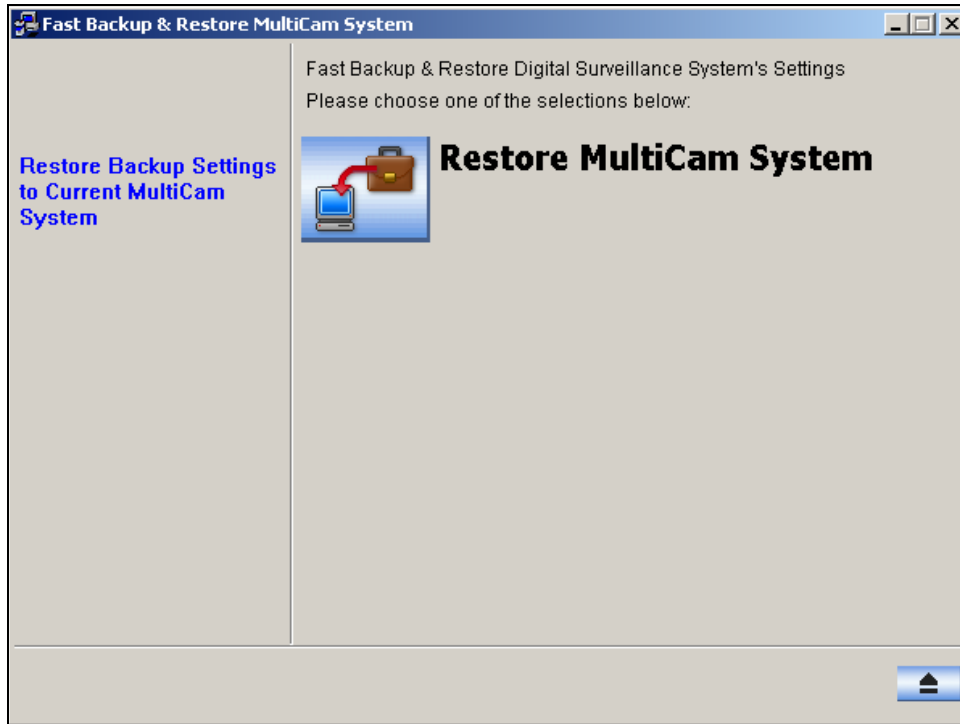

**Figure 10-40**

2. Click the **Restore Multicam System** icon, and then select which backup settings you want to restore.
3. Press the **Next Step** button  to start restoring.
4. When the restoration is complete, this message will appear: *Successfully Restore MultiCam System Settings.*

## Hot-Swap Recording

The program Media Man Tool provides a hot-swap feature, allowing a non-stop recording. You can add and remove a hot-swap or portable hard drive to the GV-System while the monitoring keeps on. When the new drive is added, it will be configured to the recording path automatically.

Additionally, you can back up ViewLog player and files to play back at any computer.

---

**Note:** The hot-swap feature supports the disk capacity of 2 GB at least.

---

## The Media Man Tool Window

This program comes with the installation of Main System. Click Windows **Start**, point to **Programs**, select the GV folder and then select **Hot Swap HDD Tool**. This window appears.

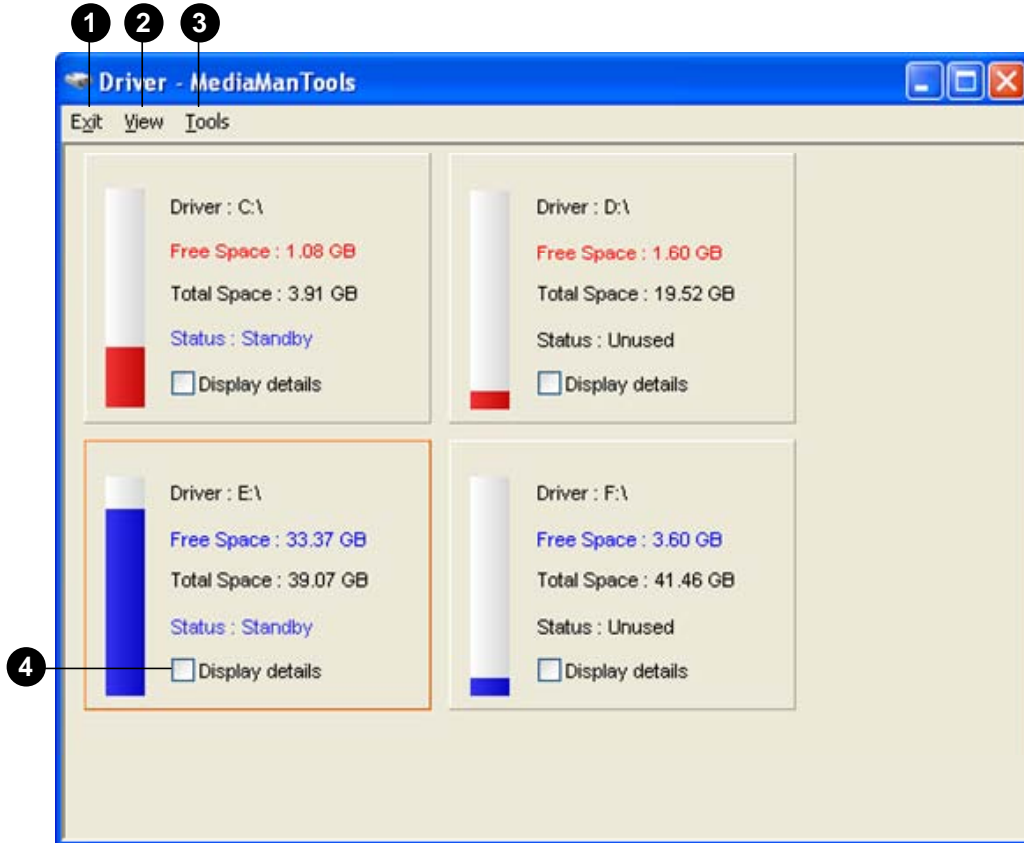

**Figure 10-41**

The controls in this window:

No.	Name	Description
1	Exit	Closes or minimizes the Median Man Tool window.
2	View	Refreshes the disk drive status shown in this window.
3	Tools	Sets up the LED panel and automatically logs in the Media Man Tool window.
4	Display Detail	Select the option to view the status and information of the disk drives. For details, see <i>Viewing Disk Drive Status</i> later in this chapter.



## Viewing Disk Drive Status

To view the detailed information of a drive, check **Display details** in the desired drive section. Its status window appears.

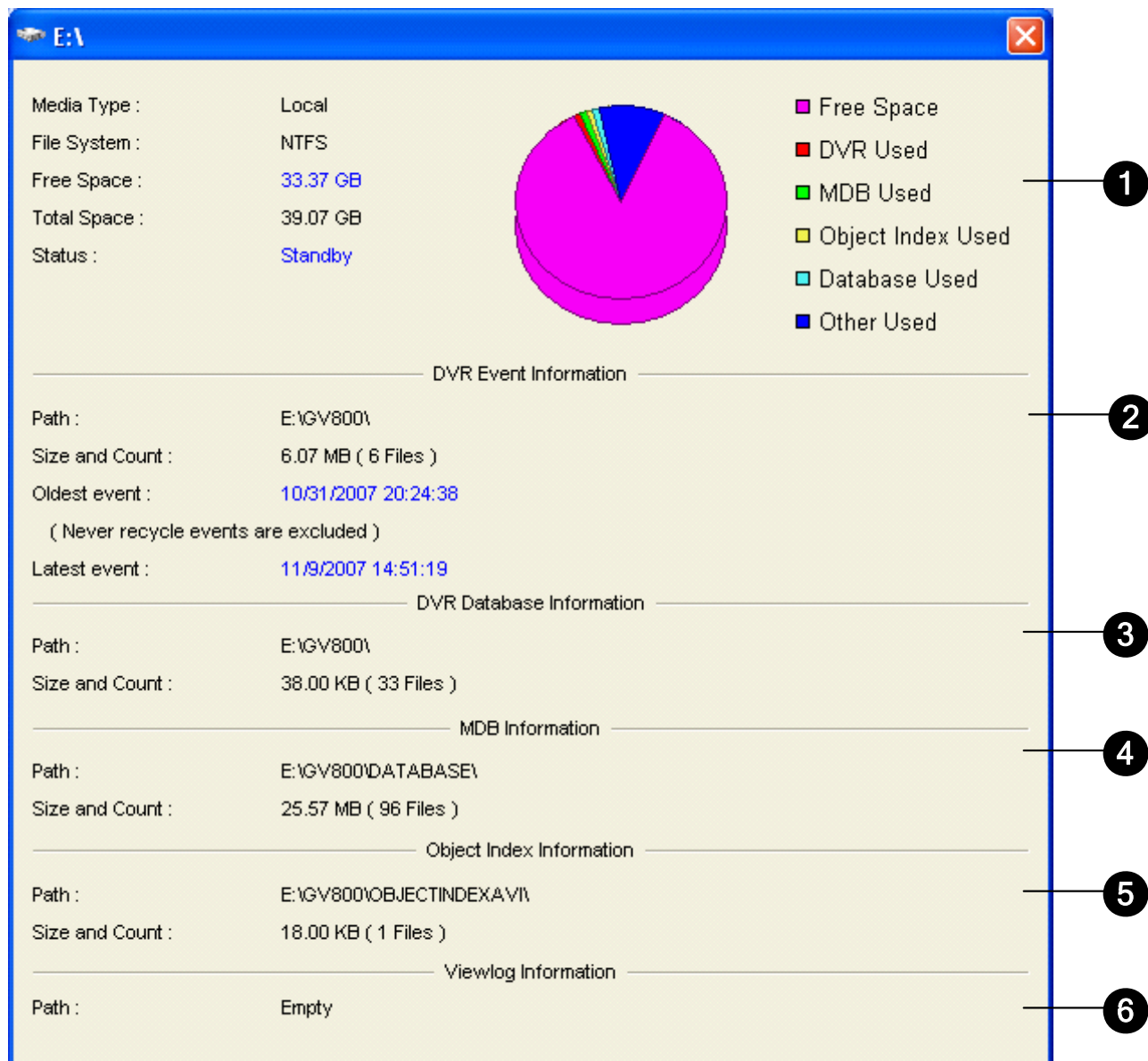

Figure 10-42

The controls on the MediaMan window:

No.	Name	Description
1	Disk Properties	<p>Indicates disk information.</p> <p>In "Media Type," two messages may appear:</p> <ul style="list-style-type: none"> <li>● <b>LAN:</b> indicates a hard drive is connected.</li> <li>● <b>Local:</b> indicates a local hard drive is connected.</li> </ul> <p>In "Status", three messages may appear:</p> <ul style="list-style-type: none"> <li>● <b>Standby:</b> indicates the hard drive already specified as the recording path.</li> <li>● <b>Unused:</b> indicates the hard drive not specified as the recording path.</li> <li>● <b>Recording:</b> indicates the files are being recorded to the disk.</li> </ul>
2	DVR Event Info	Indicates the path, size and number of recorded events; the dates of the oldest and latest events.
3	DVR Database Info	Indicates the path, size and number of the ViewLog Event List log files.
4	MDB Info	Indicates the path, size and number of System Log files.
5	Object Index Info	Indicates the path, size and number of Object Index files.
6	ViewLog Info	Indicates the location you have backed up the EZ ViewLog player.

**Note:** The DVR Event Info updates every minute. The MDB Info, DVR Database Info, Object Index Info and ViewLog Info update as data changes.

## Adding a Disk Drive

1. Click Windows **Start**, point to **Programs**, select the GV folder and select **Hot Swap HDD Tool**.
2. Insert a hot-swap hard drive or plug a portable hard drive to your computer. This dialog box appears.

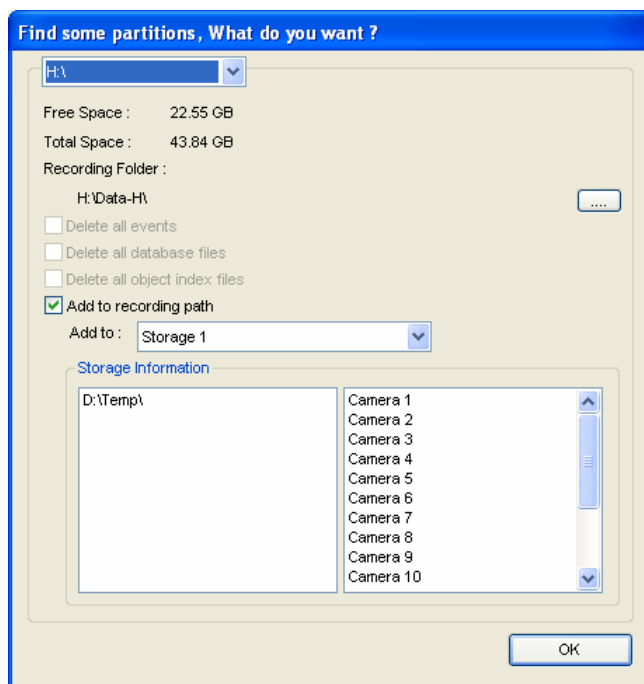

**Figure 10-43**

3. Select the **Add to recording path** option and select the storage group from the drop-down list.
4. If there are recording files saved on the hard drive, you may select the options of **Delete all events**, **Delete all database files** or **Delete all object index files**.
5. Click **OK** to automatically configure the hard drive to the recording path.
6. To verify the hard drive is added successfully, check if the “Status” of the drive displays *Standby*. Or in the Main System, click the **Configure** button, point to **General Setting**, select **System Configure**, click the **Set Location** button, and then select the **Storage Group Folder** to confirm the new recording path.

---

**Tip:** To add local drives for storage, right-click the desired drive, select **Add for recording** and follow Step 3 to add the drive.

---

## Removing a Disk Drive

To remove a disk drive from the recording path, right-click the desired drive, and select **Remove from recording path**. This dialog box will appear. You can select related files to export with the video files on the hard drive.

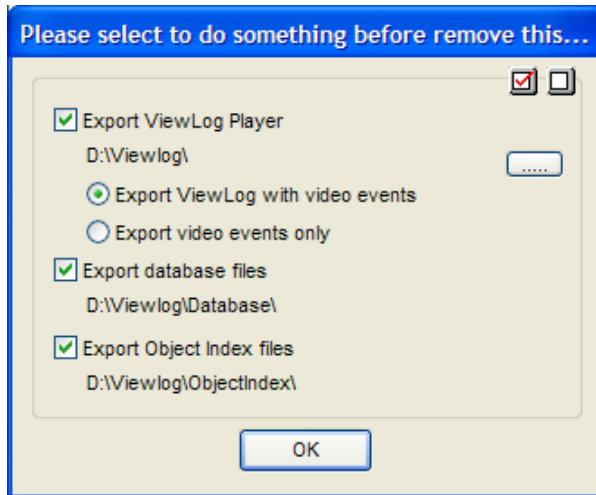

*Figure 10-44*

- **Export ViewLog Player:**

- ⊙ **Export ViewLog with video events:** Exports the ViewLog player together with video files. The ViewLog player allows you to play back the files on any computers.
- ⊙ **Export video events only:** Exports video files without the ViewLog player.

If you want to change the default folder “Viewlog” created on the disk drive, click the [...] button.

- **Export database files:** Exports the log files that correspond to the video files on this drive.
- **Export Object Index files:** Exports the Object Index files that correspond to the video files on this drive.

---

**Note:** Removing the hard drive will affect ViewLog database. To restore these events, add the hard drive back to the system and run **Repair Database Utility**.

---

## Auto Logging In and Minimizing Media Man Tools Window

To automatically log in and minimize the Media Man Tools window, follow these steps:

1. Click **Tools** on the menu bar, and select **Auto Login when windows startup**. A dialog box appears.
2. Type the ID and password of the GV-System for automatic login in the future.
3. If you want to minimize the Media Man Tools window to the system tray at startup, select **Auto minimize when startup**.
4. Click **OK** to apply the settings.

## Setting Up LED Panel

A LED panel on the screen provides a quick indication of the activity status of hard disk drives.



Figure 10-45

LED Color	Description
Gray	No HDD is assigned to this LED.
Green	A HDD is assigned to this LED.
Red	The HDD is full.
Flashing Green	GV-System is recording or the video / audio files are played back in ViewLog.
Flashing Red	The HDD is recycling.

1. Click **Tools** on the menu bar and select **Setup LED Panel**. This dialog box appears.

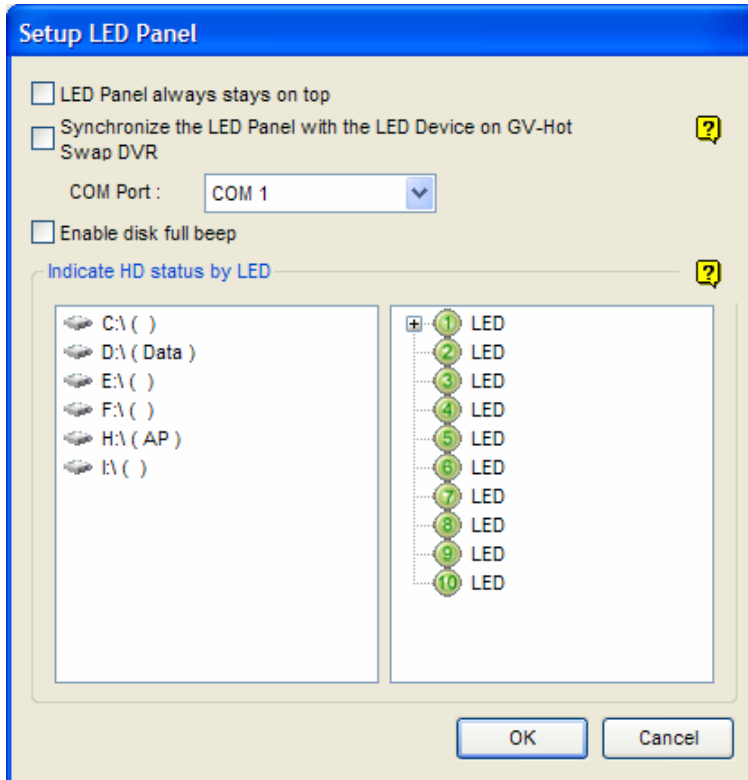

Figure 10-46

- **LED Panel always stays on top:** This option makes the LED panel stay on top of other windows when the Media Man Tools window is minimized.
  - **Synchronize the LED Panel with the LED Device on GV-Hot Swap DVR:** This option is designed for the use of the GV-Hot Swap DVR System. When this option is enabled, the LED device installed on the front panel of the GV-Hot Swap DVR System will synchronize with the LED panel on the screen.
  - **Enable disk full beep:** When the hard disk drive is full, the system sounds on. Note this function only works when the motherboard is equipped or installed with a PC speaker.
2. By default, only the hard disk drive that stores video and audio files will be assigned to LED. If you want to re-assign the hard disk drive or assign other drives to LEDs, freely move the hard disk drive to the desired LED on the tree.
  3. Click **OK** to apply the settings, and minimize the Media Man Tool window to display the LED panel on the screen.
  4. If you want to return to the Media Man Tools window, right-click the LED panel and select **Switch to main viewer**.

---

**Note:**

1. Because the LEDs are designed to indicate the video and audio files are being written or read, it is not recommended to assign the HDDs that store log files to the LEDs.
  2. If the HDD that stores log files is assigned to a LED and its LED turns red, make sure the log files are not being written before you remove it. Otherwise, the log files might be lost during the removal. For details on specifying storage locations of logs and video/audio files, see the option "Set Location" in *Configuring Global Recording Parameters* in Chapter 1.
-

## Backup Server

You can back up recording files and log data of the GV-System to an external iSCSI storage system over the Internet. In iSCSI (Internet SCSI) storage protocol, there are two ends in the connection: initiator and target. The initiator, located at the host side, requests any iSCSI communication like read or write. The target is the storage device itself that controls and serves volumes. The figure below illustrates multiple GV-Systems back up files to one iSCSI storage system over Internet.

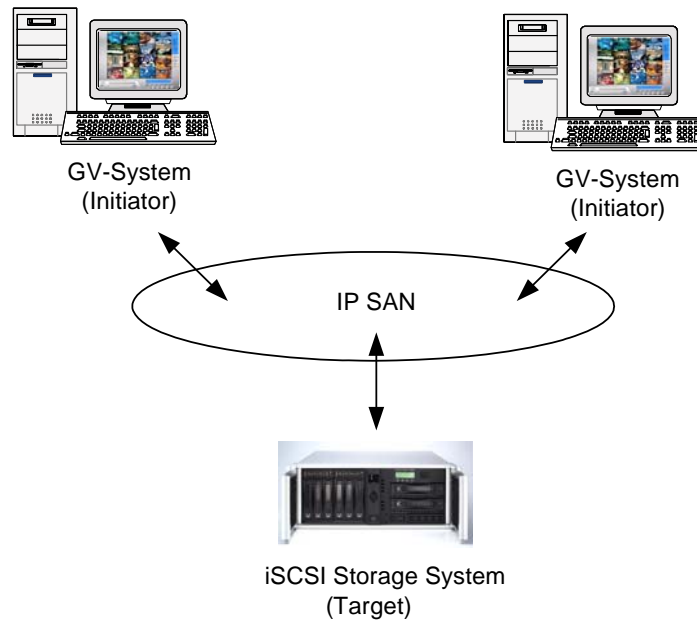

**Figure 10-47**

The host GV-System needs an iSCSI initiator. The iSCSI initiator is a driver, which handles the traffic over iSCSI. Install and download the iSCSI initiator from [Microsoft Download Center](#). After the installation, the Microsoft iSCSI initiator icon will be created on the desktop. Consult the documentation of your iSCSI storage system to configure the iSCSI initiator and build connection to the storage system.

---

**Note:** If you are using Windows Vista, there is no need to install the Microsoft iSCSI initiator because it has been integrated into Windows Vista.

---

## Usage Requirement

You must meet the following requirement when creating node name accounts on the storage system:

- Each node name account is applied only for each host/computer to use. It is restricted to apply one node name account on different hosts/computers due to data conflict.



## Connecting to the Storage System

Before connecting the GV-System to the storage system, make sure you have installed and set up Microsoft iSCSI initiator.

1. At the GV-System, click the **Network** button, and select **Backup Server**. This dialog box appears.

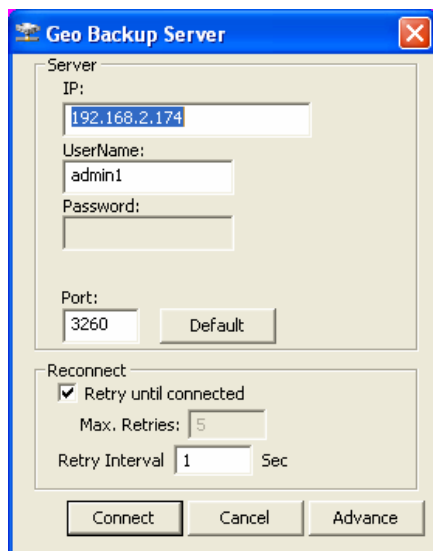

**Figure 10-48**

2. Type the IP address and user name of the storage system. Modify the port if necessary.
3. If you want the system to automatically retry to build connection, specify the number of retry attempts and the time of retry interval in seconds, and then select **Retry until connected**.
4. Click **Connect** to start the connection.
5. Once the connection is established, a Backup Server icon  appears on the system tray.

---

**Note:** The storage system will follow the recycle setting on the GV-System. For example, you set the recycle size of 800 MB on the GV-System. When the connected hard disk from the storage system reaches the limit of 800 MB, the recycle starts and the oldest files are overwritten.

---

## Advanced Settings

You may want to configure the Backup Server to fit into your own needs. In the Geo Backup Server dialog box (Figure 10-48), click **Advance**. The Advance Settings dialog box appears.

### [General]

You can select the bandwidth speed to ensure the quality connection.

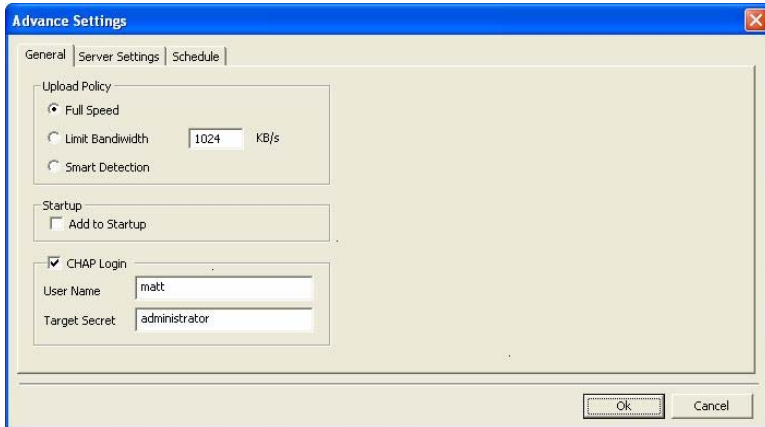

**Figure 10-49**

### [Upload Policy]

- **Full Speed:** Build the connection at full maximum speed.
- **Limit Bandwidth:** Specify the desired bandwidth limit in kb/s.
- **Smart Detect:** Automatically detect the file size and decide the proper bandwidth speed.

**[Startup]** Automatically starts the Backup Server at Windows startup.

**[CHAP Login]** If the CHAP authentication is enabled on the storage system to secure data transmission over the network, you must select the **CHAP Login** option, and type **User Name** and **Target Secret** (password) created on the storage system; otherwise you cannot log in the storage system.

## [Server Settings]

You can select the files of cameras to be backed up, and the way of notification when the network is disconnected.

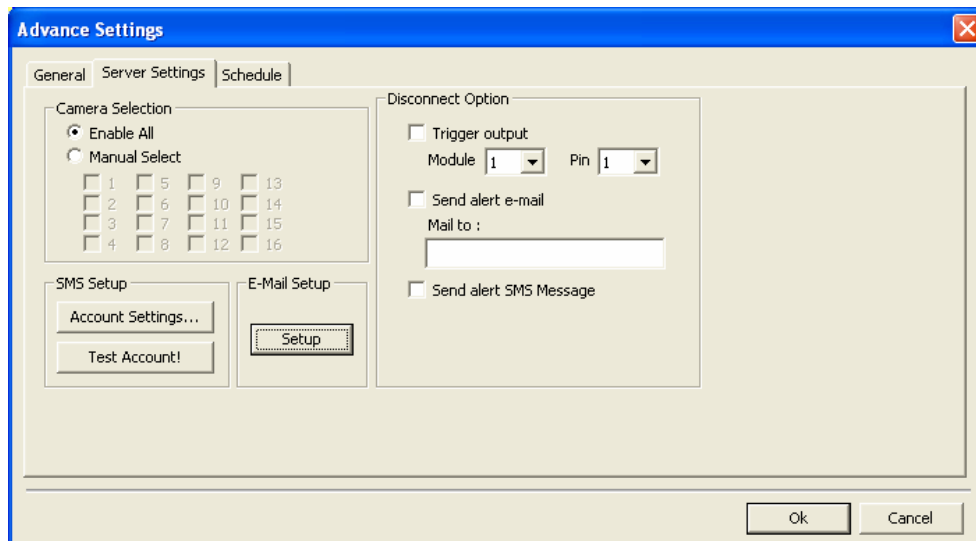
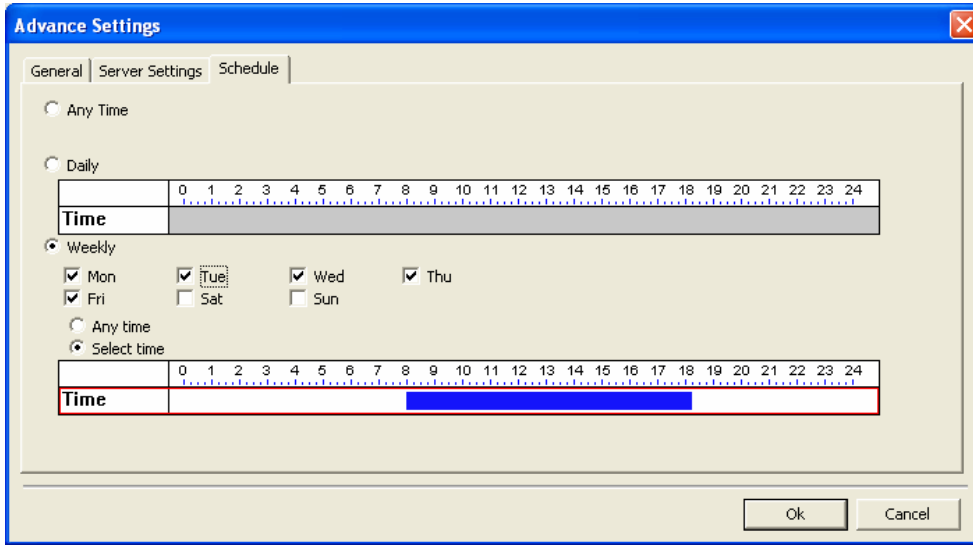

**Figure 10-50**

- **Camera Selection:** Select the files of desired cameras to be backed up.
- **Disconnect Option:** Select the alert methods when the network is disconnected.
  - ⊙ **Trigger output:** Trigger the specified output module and pin for alerts.
  - ⊙ **Send alert e-mail:** An e-mail message is sent out for alerts. Before using this function, click the **Setup** button in the E-Mail Setup field to set up an e-mail account.
  - ⊙ **Send alert SMS Message:** A SMS message is sent out for alerts. Before using this function, click the **Accounts Settings** button in the SMS Setup field to set up a SMS account.

## [Schedule]

You can plan the time to back up the files to the storage system.



**Figure 10-51**

- **Any Time:** The backup starts whenever there are files to be backed up.
- **Daily:** The backup starts at the set time of a day. Drag the mouse over the timeline to define the start and end time.
- **Weekly:** The backup can start at any time or the specified time of a week. To specify the time, select the desired days (Mon – Sun), select **Select Time**, and then drag the mouse over the timeline to define the start and end time.

## Manually Adding Files for Backup

It is automatic to back up the files from the GV-System to the storage system once the connection is built. To manually select the files for backup:

1. Click the Backup Server icon on the system tray, and then select **Add Files**. This dialog box appears.

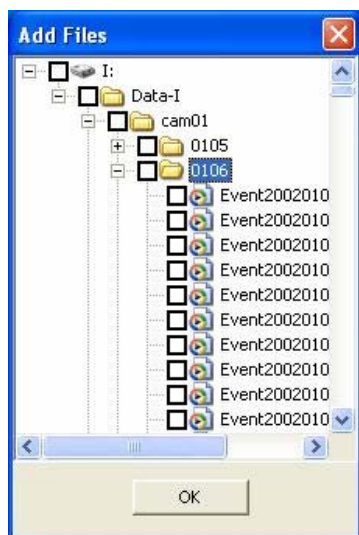

**Figure 10-52**

2. Expand the hard disk drive folders and select the file folders for backup.
3. Click **OK** to start.

## Viewing Server Status

You can access the information of connection activities, backup files and backup data. To view the information, click the Backup Server icon on the system tray and select **Server Status**. The Upload Info dialog box appears.

### [Event Log]

This tab shows the history of connection activities. Note that the latest event is always placed on the top.

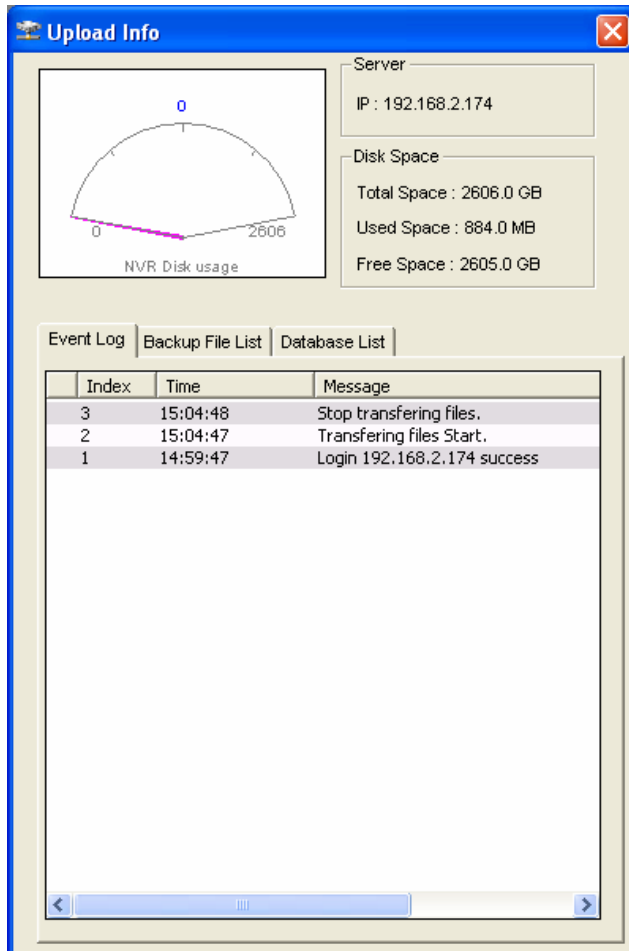

**Figure 10-53**

## [Backup File List]

This tab displays the files being backed up. Click **File View** to display the backup files by file names or click **Camera View** to display the backup files by cameras.

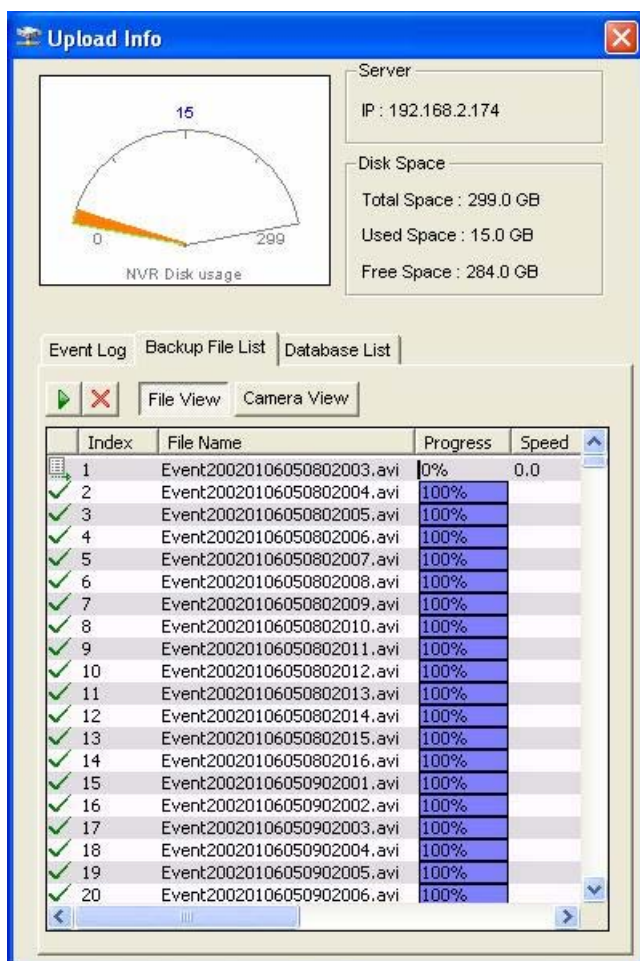

Figure 10-54

**Tip:** To view the information of the backup file, click the file event. This dialog box will appear.

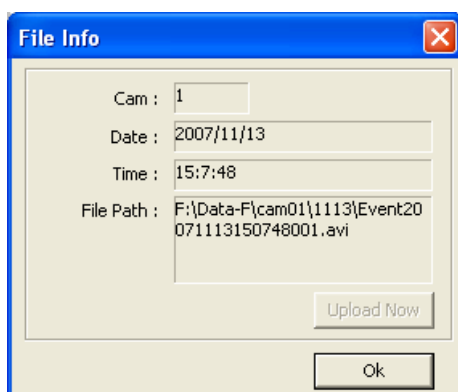

Figure 10-55

### [Database List]

The related log data, including system log and POS data, will be backed up to storage system with the recording files. Note that the record only appears on the next day of file transference.

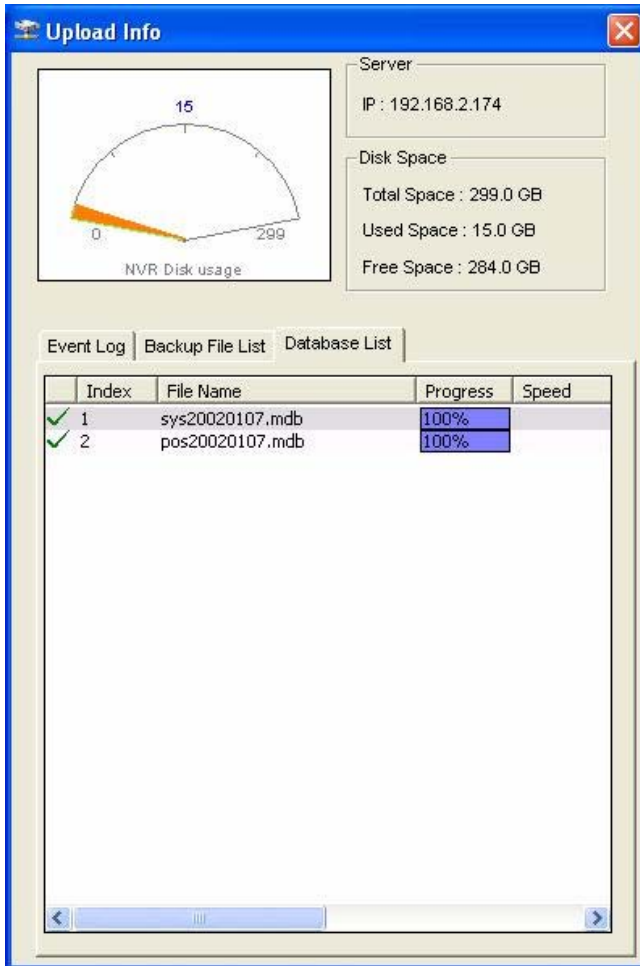

Figure 10-56



## Retrieving Recorded Files

You can retrieve files from the storage system and play video back.

1. On the ViewLog screen, click the **Tools** button, and select **Remote Backup Server**. This dialog box appears.

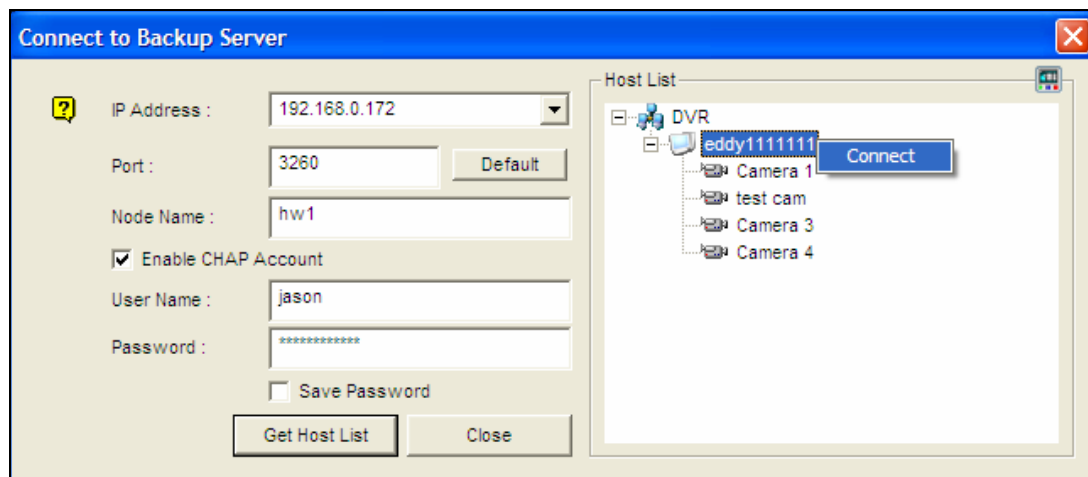
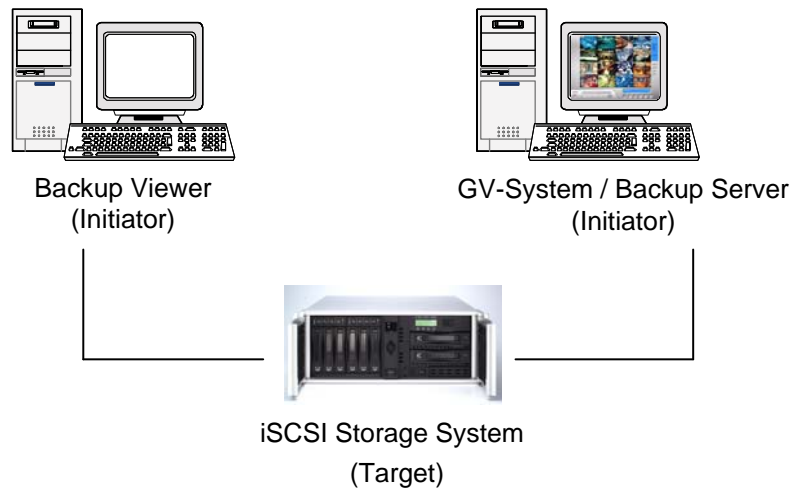

**Figure 10-57**

2. Type the **IP address** of the storage system and initiator **Node Name**. Modify the port number if necessary.
3. If the CHAP authentication is enabled on the storage system to secure data transmission over the network, you have to select **Enable CHAP Account**, type **User Name** and **Password** created on the storage system; otherwise you cannot log in the storage system.
4. Click the **Get Host List** button to start.
5. When the storage system appears on the Host List, click the button on the top right corner, or right-click the list and select **Connect** to start connection.
6. When the connection is established, you will see the events stored on the storage system appear on the Event List. Then you can use all ViewLog features for playback.

## Backup Viewer

With the Backup Viewer, you can access the video recordings and log data backed up at the iSCSI storage system over the Internet from any computer. You can search the log data, view, edit and save the recordings at the local computer.



**Figure 10-58**

## Usage Requirements

You must meet the following requirements when building the Backup Viewer and creating the node name account on the storage system:

- The Backup Viewer is not appropriate to be installed on the computer of Backup Server (GV-System) due to node name account conflict.
- Only apply the node name account of "Read-Only" to the Backup Viewer due to data conflict.

## Installing Backup Viewer

1. Insert the Surveillance Software CD, click **Install V8.2.0.0 System**, select **Backup Viewer** and follow the onscreen instructions.
2. The Microsoft iSCSI initiator will be installed together with the Backup Viewer. Consult the documentation of your iSCSI storage system to configure the iSCSI initiator and build connection to the storage system.

## Starting Backup Viewer

Before connecting the Backup Viewer to the storage system, make sure you have set up Microsoft iSCSI initiator.

1. Go to **Start**, point to **Programs**, select **Backup Viewer**, and then click **GeoVision Backup Viewer**.
2. In the Backup Viewer window, click the **Connect** button  on the toolbar. This dialog box appears.

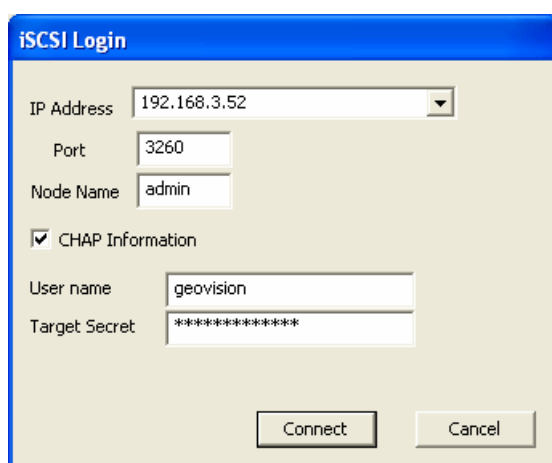

**Figure 10-59**

3. Type the **IP address** of the storage system and initiator **Node Name**.
4. If the CHAP authentication is enabled on the storage system, you have to select **CHAP Information** option, type **User Name** and **Target Secret** (password) created on the storage system; otherwise you cannot log in the storage system.
5. Click **Connect** to start. When the connection is established, the recordings are listed and displayed.

## Performing Queries

On the iSCSI tab, you can search events or log data stored on the connected storage system.

This feature shares the same GUI and functions with the Event List Query function on WebCam Server. For details, see *Event List Query* in Chapter 6.

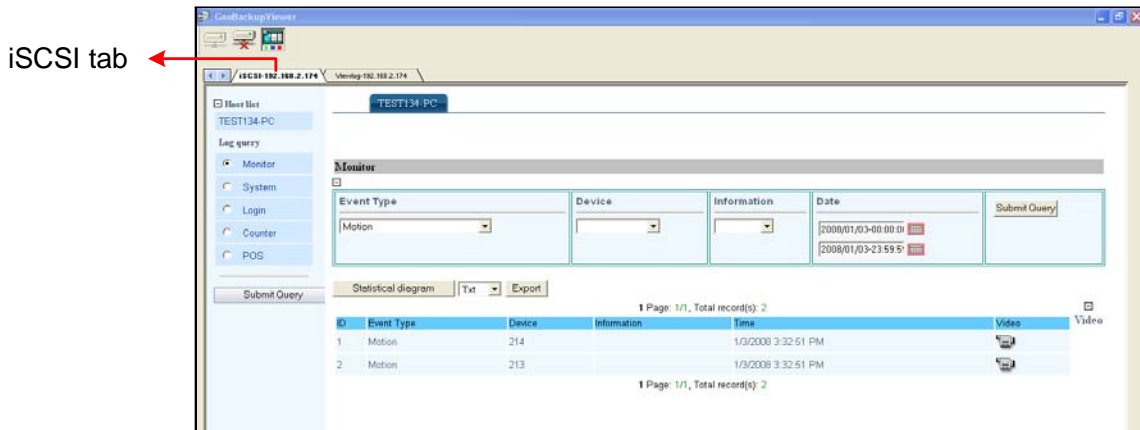

Figure 10-60

## Viewing the Event Files

On the ViewLog tab, you can retrieve the recordings from the storage system and play video back.

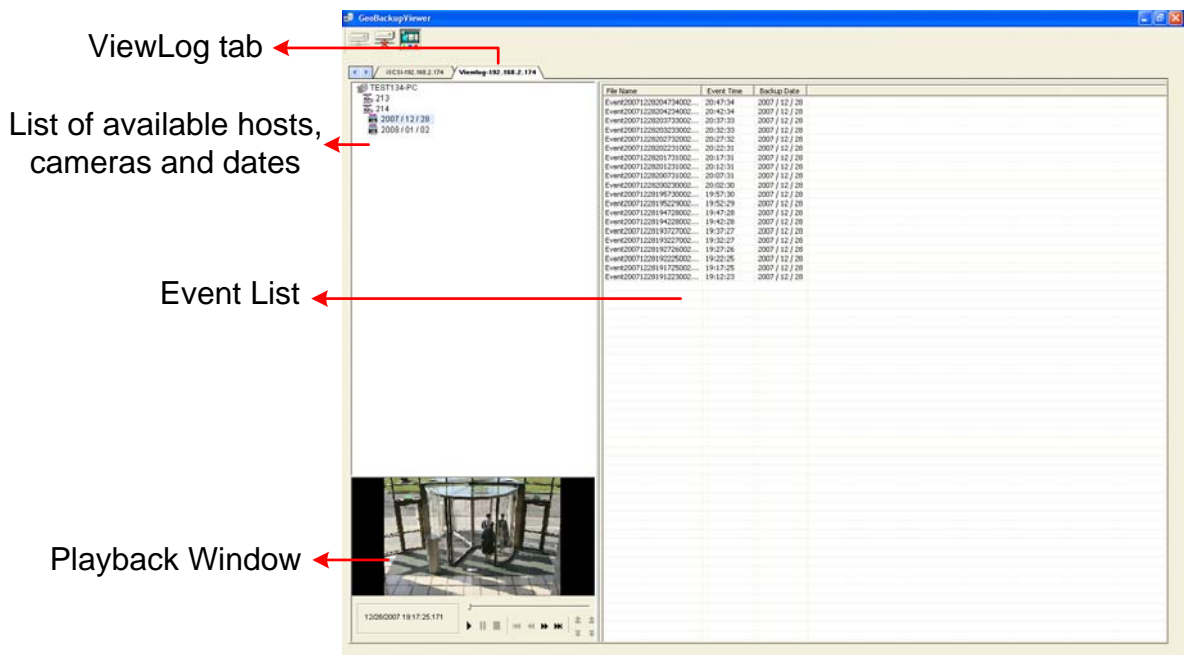



Figure 10-61

Right-clicking the playback window can change the play mode and create special effects when you play video back.

Name	Functions
<b>Play Mode</b>	<p>Includes these options:</p> <ul style="list-style-type: none"> <li>● <b>Frame by Frame:</b> Plays back video frame by frame.</li> <li>● <b>Real Time:</b> Plays back video on real time. This mode saves waiting time for rendering, but drop frames to give the appearance of real-time playback.</li> <li>● <b>Audio:</b> Turns on or off the video sound; audio denoise.</li> </ul>
<b>Render</b>	<p>Includes these options:</p> <ul style="list-style-type: none"> <li>● <b>Deinterlace:</b> Converts the interlaced video into non-interlaced video.</li> <li>● <b>Scaling:</b> Smoothens mosaic squares when enlarging a playback video.</li> <li>● <b>Deblocking:</b> Removes the block-like artifacts from low-quality and highly compressed video.</li> <li>● <b>Defog:</b> Enhances image visibility.</li> <li>● <b>Stabilizer:</b> Reduces camera shake.</li> <li>● <b>Text overlay's camera name and time:</b> Overlays camera name and time onto the video.</li> <li>● <b>Text overlay's POS/GV-Wiegand:</b> Overlays POS or GV-Wiegand Capture data onto the video.</li> <li>● <b>Full Screen:</b> Switches to the full screen view.</li> </ul>
<b>Tools</b>	<ul style="list-style-type: none"> <li>● <b>Snapshot:</b> Saves a video image.</li> <li>● <b>Save as AVI:</b> Saves a video as avi format.</li> <li>● <b>Download:</b> Downloads the video clip from the DVR or video server to the local computer.</li> </ul>

## Using Remote ViewLog

Using the Remote ViewLog function, you can access the data on the GV-System, click the **Remote ViewLog** button  on the toolbar, and this dialog box appears. Type the IP address, ID and Password of the GV-System, select **DVR** in the Host Type field, and the click **Connect** to enable connecting to the GV-System.

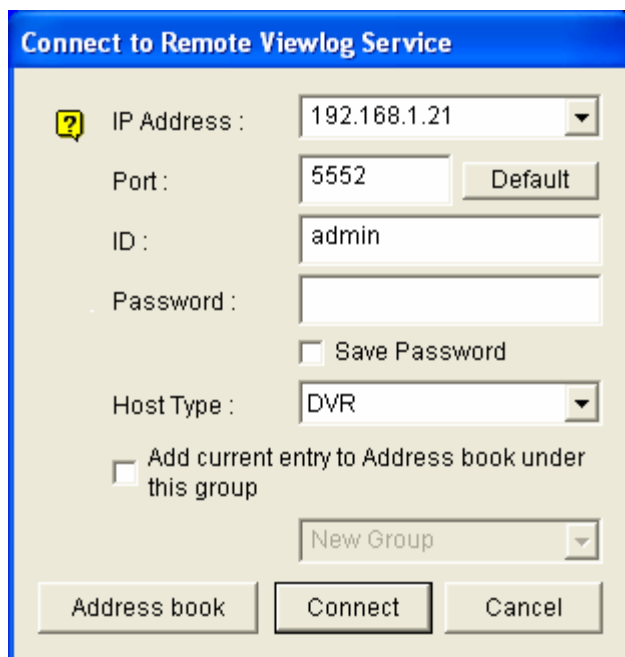

The dialog box titled "Connect to Remote Viewlog Service" contains the following fields and controls:

- IP Address :** A text box containing "192.168.1.21" with a dropdown arrow.
- Port :** A text box containing "5552" and a "Default" button.
- ID :** A text box containing "admin".
- Password :** An empty text box.
- Save Password
- Host Type :** A dropdown menu with "DVR" selected.
- Add current entry to Address book under this group
- A "New Group" dropdown menu.
- Buttons: "Address book", "Connect", and "Cancel".

**Figure 10-62**

## Bandwidth Control Application

The Bandwidth Control is an independent application that controls and monitors the network traffic of the WebCam servers. Its features include:

- Manage up to 10 WebCam servers
- Get bandwidth usages of every Webcam server and every user
- Set bandwidth thresholds for specific users and IP addresses
- IP black and white list
- Kick unwanted users

---

**Note:** The Bandwidth Control application only works on Internet Explorer. If the user logs in the WebCam server using other browsers, e.g. Netscape and FireFox, the Bandwidth Control cannot detect and manage the login user. However, the user of other browsers has access to JPEG and live images only.

---

## Running the Bandwidth Control

1. On the computer you want to install the Bandwidth Control program, insert the Surveillance System Software CD, click **Install GeoVision V 8.2.0.0.0 System**, select **Bandwidth Control Client Site**, and follow the onscreen instructions.
2. After the installation is complete, double-click the **Bandwidth Remote Control** icon created on the desktop. The Bandwidth Control window appears.

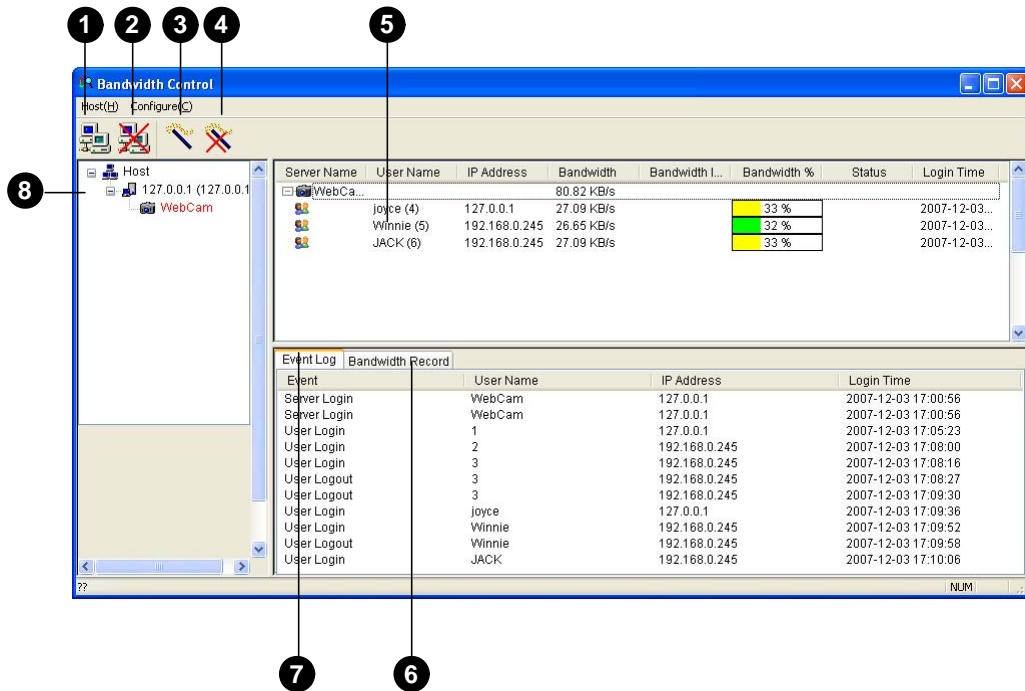

Figure 10-63

No.	Name	Description
1	Connection	Builds the connection to a WebCam server.
2	Disconnect	Stops the connection to a WebCam server.
3	Get Control	Obtains the right to remotely control the WebCam servers.
4	Give Up Control	Ceases controlling the WebCam servers and users.
5	User List	Displays the connected users and their status
6	Bandwidth Record	Displays the network traffic in graph display.
7	Event Log	Records activities of WebCam servers and users.
8	Host List	Displays all WebCam servers to be connected.



## Allowing Remote Control at DVR

The network traffic of WebCam server can be controlled when the DVR permits the remote control from the Bandwidth Control program by the following steps:

1. Click the **Network** button, and select **WebCam Server**.
2. On the General tab, select the **Run Bandwidth Control server** option. When this option is enabled, on the Control Center Server option list, the “Bandwidth Control Service” is marked with a check.

## Connecting to a WebCam Server

1. Click **Host** on the menu bar, and select **Connection**. Or you can click the **Connection** button on the toolbar. This dialog box appears.

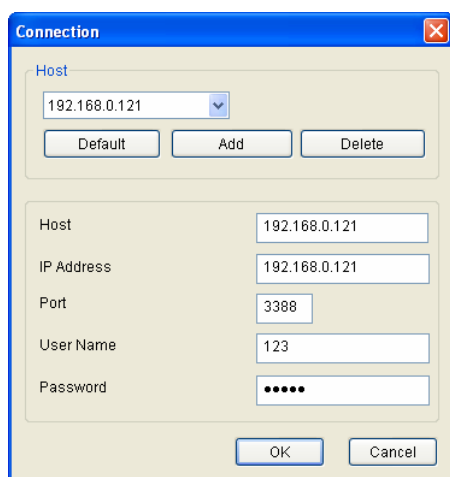

**Figure 10-64**

2. To add a WebCam server to be connected to, click **Add**.
3. Type host name, IP address, user name and password of the WebCam server. Modify the port if necessary.
4. Click **OK**. If the connection is established, the WebCam server shows up in the Host List.
5. You can add up to 10 WebCam servers by repeating above steps.
6. To stop the connection, select the host and click the **Disconnect** button.
7. Up to 5 users of the Bandwidth Control programs can connect to a single WebCam server for network traffic monitoring. However, only one user has access to bandwidth settings. When this user clicks the **Give Up Control** button, the user no longer controls the WebCam server. Whoever clicks the **Get Control** button first has access to bandwidth settings. For bandwidth settings, see *Controlling a WebCam Server* below.

## Controlling a WebCam Server

To disconnect a login user or set the bandwidth limit for a user, right-click the user to have these options:

Server Name	User Name	IP Address	Bandwidth	Bandwidth L...
WebCa...			83.85 KB/s	
	Winnie (5)	192.168.0.245	9.97 KB/s	20 KB/s
	JACK	192.168.0.245	36.42 KB/s	
	joyce		37.45 KB/s	

**Figure 10-65**

- **Kick:** Disconnects the user from the WebCam server.
- **Bandwidth Setup:** Select **By Username** to specify a bandwidth limit for the user, or select **By IP** to limit the bandwidth used by the IP address. A setup dialog box will appear. In this example, an IP address is selected for bandwidth limit setup. Select **Bandwidth Setup**, specify a bandwidth limit, and then click **OK**.

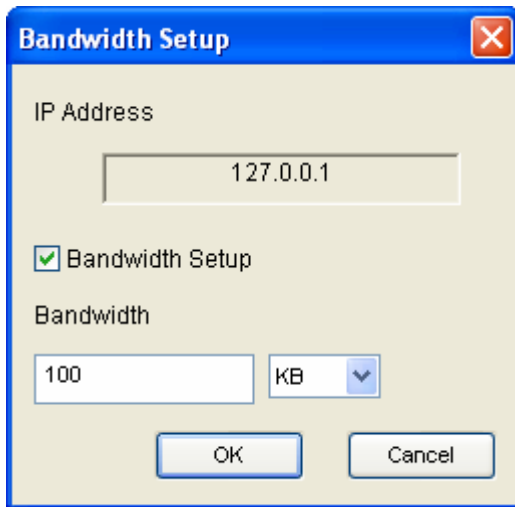
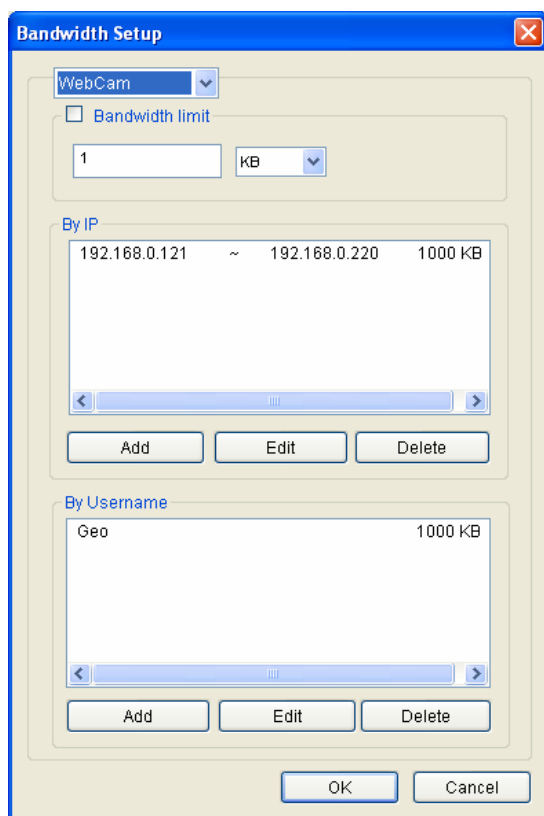

**Figure 10-66**

## Bandwidth Setup

You can specify the total bandwidth allocated to a WebCam server. You can also specify the bandwidth for certain users and IP addresses. This is especially useful when your network is busy or heavily loaded.

1. Click **Configure** on the menu bar, and select **Bandwidth Setup**. A dialog box prompts for you to select a host.
2. Select the desired WebCam server, and click **OK**. This dialog box appears.



**Figure 10-67**

- **Bandwidth limit:** Select this option, and define the total bandwidth that the WebCam server will be allowed to use on your network.
- **By IP:** Click the **Add** button, and specify a specific IP address or a range of IP addresses and its bandwidth limit.
- **By Username:** Click the **Add** button, and specify the user name and its bandwidth limit.

---

**Note:** If you have already specified the total bandwidth to a WebCam server, it is prioritized before the bandwidth limits set to user names and IP addresses.

---

## Block List Setup

Two types of block lists are provided to restrict access to a WebCam server: permitting and denying a specified range of IP address to establish the connection. Note that only one type of block list can be used at one time.

1. Click **Configure** on the menu bar, and select **IP White / Black List Setup**. A dialog box prompts for you to select a host.
2. Select the desired WebCam server, and click **OK**. This dialog box appears.

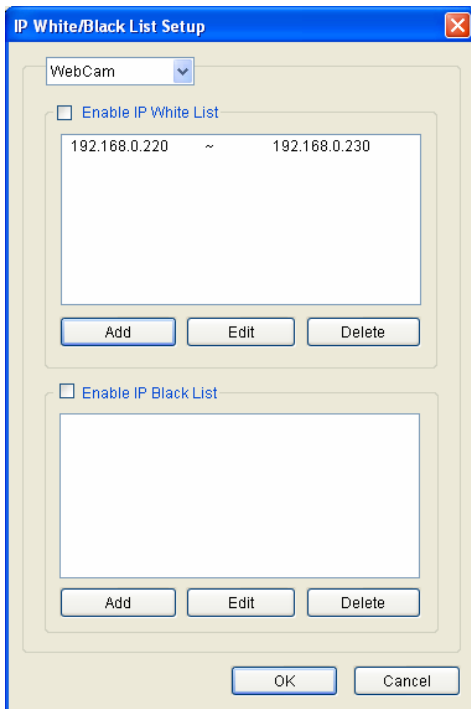
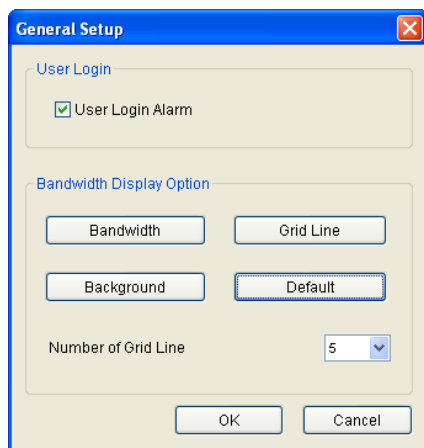

**Figure 10-68**

3. Select the type of block list you want to use, and click **Add** to define the IP addresses.
  - **Enable IP White list:** Allows the defined range of IP addresses to establish the connection.
  - **Enable IP Black list:** Prohibits the defined range of IP addresses from establishing the connection.
4. Click **OK** to apply the settings.

## General Setup

You can set up sound alarm when a user logs in, or change the real-time graph display of network traffic. Click **Configure** on the menu bar and select **General Setup**. This dialog box appears.



**Figure 10-69**

- **User Login Alarm:** Computer alarm sounds on when a user logs in.
- **Bandwidth:** Sets the color of bandwidth wave.
- **Grid Line:** Sets the color of the grid lines of graph.
- **Background:** Sets the background color of the graph.
- **Default:** Sets the color of graph display at default.
- **Number of Grid Line:** Use the drop-down list to select how many grid lines to be displayed.

When you click the **Bandwidth Record** tab in the Bandwidth Control window, you can view the network traffic in graph.

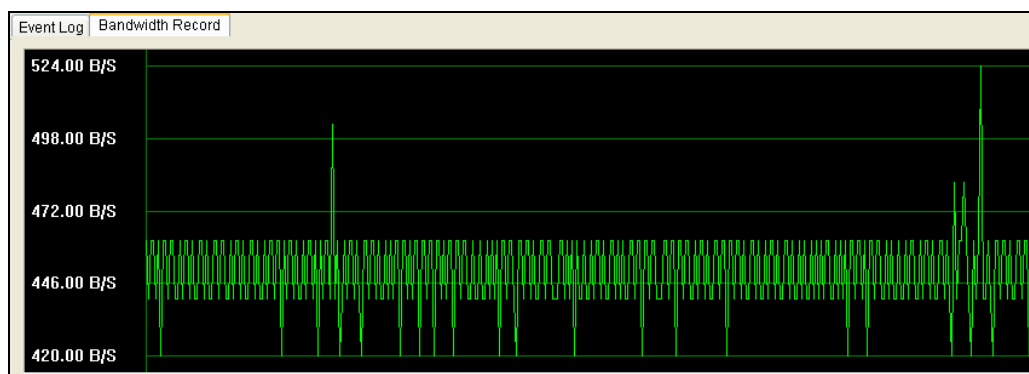

**Figure 10-70**

## Report Generator

With the Report Generator, you can generate a daily or weekly report based on the specified recording data. The report can be either generated manually or automatically by schedule. The report is available in two types of formats: MDB and HTML. You can save the report on the hard disk, send it to a specified e-mail address or have it to be dealt in both ways. If the reports indicate the video recordings of events, you can play them back via Internet connection.

### Starting Report Generator

1. The Report Generator program is included in the installation of Main System. Double-click **ReportGenerator.exe** from the GV program folder to run the program.
2. Type the ID and password of the GV-System when you are prompted to log in.

### Setting Up Report Generator

In the Report Generator dialog box, click the **Advanced Setting** tab.

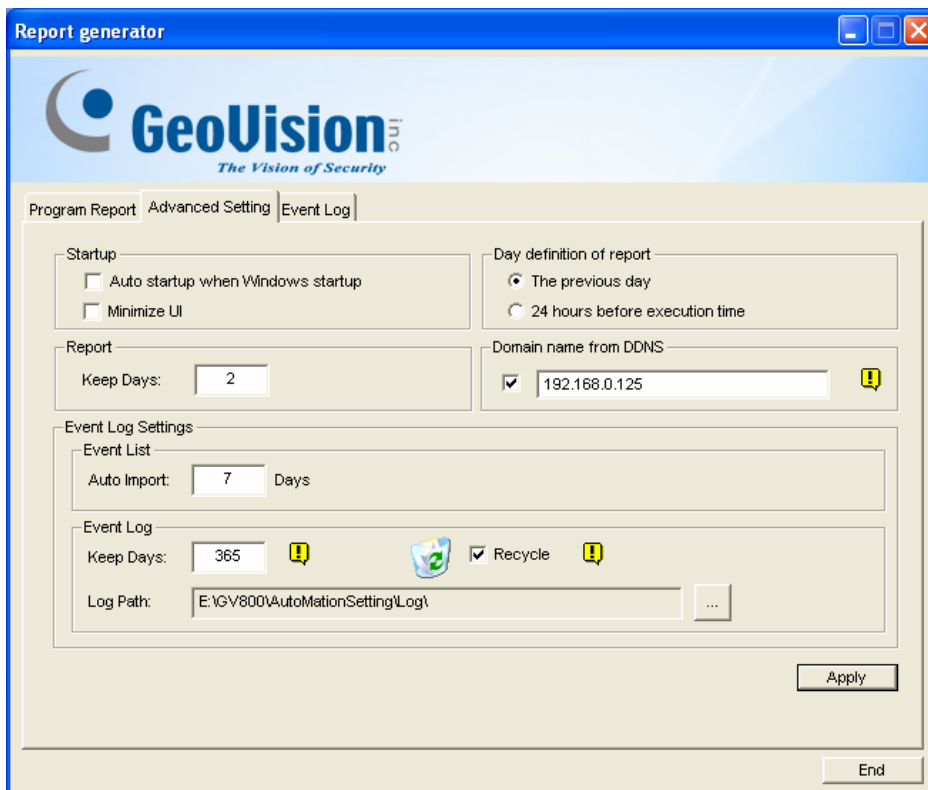

Figure 10-71

**[Startup]**

- **Auto startup when Windows startup:** Select this option to start Report Generator automatically at Windows startup.
- **Minimize UI:** Select this option to minimize the Report Generator after it is started.

**[Day Definition of Report]** Define the time period of data to be included in the report.

- **The previous day:** The report is generated on the previous day's data.
- **24 hours before execution time:** The report is generated on the data from 24 hours before report generation.

**[Report]**

- **Keep Days:** If you generate reports to the hard disk, specify the number of days to keep the report files. Up to 30 days of files can be kept. To generate reports to the hard disk, see Step 4 in *Setting Up Report Criteria* later in this chapter.

**[Domain name from DDNS]** When the report in HTML format indicates the availability of video recordings, you can establish the connection to the GV-System over Internet to play back the videos. If the GV-System has a domain name, select this option and enter the domain name to be connected. To obtain a domain name, see *Dynamic DNS* earlier in this chapter.

**[Event Log Settings]**

- **Auto Import:** Specify the number of days of Report Generator logs to be displayed when the Event Log is started. Up to seven days of data can be displayed.
- **Keep Days:** Specify the number of days to keep Report Generator logs. The logs can be kept for up to 365 days.
- **Recycle:** Select this option to delete old logs to make space for new ones when storage space is lower than 500 MB.
- **Log Path:** Select the location to store Report Generator logs.

## Setting Up Report Criteria

1. In the Report Generator dialog box, click the **Program Report** tab.

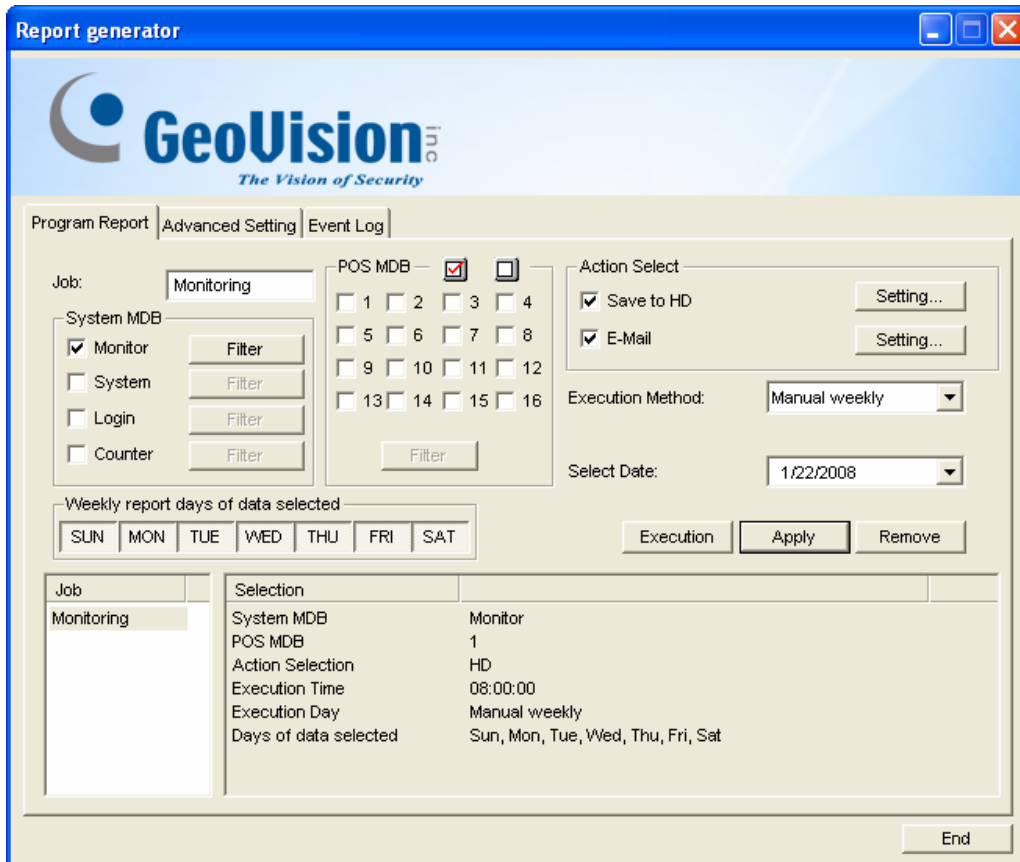

**Figure 10-72**

2. In the Job field, type a descriptive name for the report.
3. Select the types of events you want to include in the report. To set up specific criteria, click the **Filter** button beside each option.

### [System MDB]

- **Monitor:** Includes the events of motion and I/O events.
- **System:** Includes the events of functions enabled and disabled in GV-System.
- **Login:** Includes the events of who has logged in and out of GV-System and WebCam Server at what time.
- **Counter:** Includes the events of and result of GV-System's counter function.

[POS MDB] Select the cameras for searching POS event.

4. In the Action Select field, select how the report is accessed.
  - **Save to HD:** Select this option to save the report on the hard disk. Click the **Setting** button to display this dialog box.



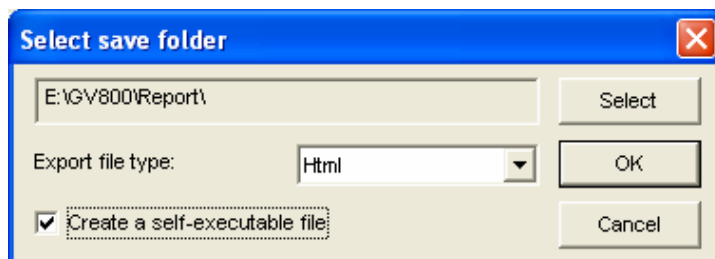

**Figure 10-73**

Click **Select** to specify the storage location, and use the drop-down list to select a report format. If you want to create a self-executable file of the report, select **Create a self-executable file**.

- **E-Mail:** Select this option to send the report to an e-mail address as an attachment. Click the **Setting** button to set up the e-mail account and attachment.

For details on setting up the e-mail account, see *Sending Alerts thru E-mail Accounts* in Chapter 1.

For details on setting up the attachment, see *E-Mail Attachment Settings* later in this chapter.

5. In the Execution Method drop-down list, choose the way and time to generate the report.

- **Everyday:** Automatically generates daily reports at a specific time. Specify the time by using the **Select Time** drop-down list.
- **Sun - Sat:** Automatically generates reports on the selected day (Sun to Sat) and at a specific time. Specify the time by using the **Select Time** drop-down list.

To select the days of data to be included in the report, click the desired day buttons.

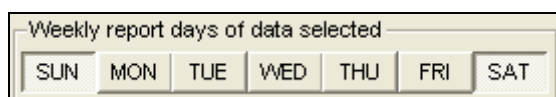

**Figure 10-74**

- **Manual daily:** Manually generates a daily report.
  - ⊙ If you select **Previous day** on the Advanced Setting tab (Figure 10-71), the report will be generated on the data of one day before your specified date. For example, you enter "12/10/2007" in the **Select Date** drop-down list. The report is generated on the data of 9th December 2007.
  - ⊙ If you select **24 hours before execution time** on the Advanced Setting tab (Figure 10-71), the report will be generated on the data of 24 hours before your specified date and time. Specify the date and time by using the **Select Date** and **Select Time** drop-down lists.

- **Manual Weekly:** Manually generates a weekly report.
  - ⊙ If you select **Previous day** on the Advanced Setting tab (Figure 10-71), the generated report will contain the data of 7 days before your specified date. For example, you enter “12/10/2007” in the **Select Date** drop-down list. The report is generated on the date from December 3rd to 9th in 2007.

To select the days of data to be included in the report, click the desired day buttons.  
See Figure 10-74

- ⊙ If you select **24 hours before execution time** on the Advanced Setting tab (Figure 10-71), the generated report will contain the data of 7 days counting back on your specified date and time. Specify the date and time by using the **Select Date** and **Select Time** drop-down lists. For example, if you enter “12/10/2007” and “01:00”, the report is generated on the time from 01:00 am, December 10th to 01:00 am, December 4th, 2007.

To select the days of data to be included in the report, click the desired day buttons.  
See Figure 10-74.

## E-Mail Attachment Settings

After you set up the e-mail account to receive the reports as e-mail attachments, you can also set up the attachment limits to avoid sending out large files.

1. On the Program Report tab, select **E-mail** and click the **Setting** button beside. This dialog box appears.

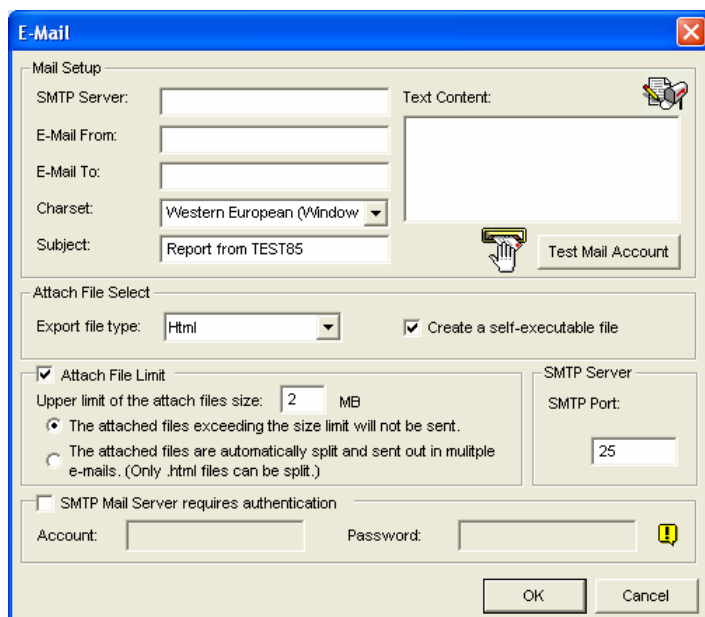

**Figure 10-75**

2. In the Attach File Select field, use the **Export file type** drop-down list to select Html or MDB as a file format. If you want to create a self-executable file of the report, select **Create a self-executable file**.
3. Select **Attach File Limit**, and decide the size limit of the attached file. Set the limit between 1 MB and 10 MB.
4. Select one of these options to set the attachment condition.
  - **The attached files exceeding the size limit will not be sent:** When the attached report file exceeds the size limit, the e-mail will not be sent.
  - **The attached files are automatically split and sent out in multiple e-mails:** If the attached file exceeds the size limit, it will be automatically split and sent out in multiple e-mails. Note this option cannot apply to the report files in .mdb format.

## Playing Back the Video Recording

In a HTML format report, the video recordings can be played back with the Remote ViewLog function. Make sure the Remote ViewLog service is enabled at the GV-System that owns those recordings.

1. It is required to install the Single Player in the computer where you want to play back the video recordings. Insert the Surveillance System Software CD, click Install GeoVision V8.2.0.0 System, select **GeoVision Main System**, select **Single Player** and then follow the on-screen instructions.
2. After the installation of Single Player is complete, open a report and click the desired video icon.

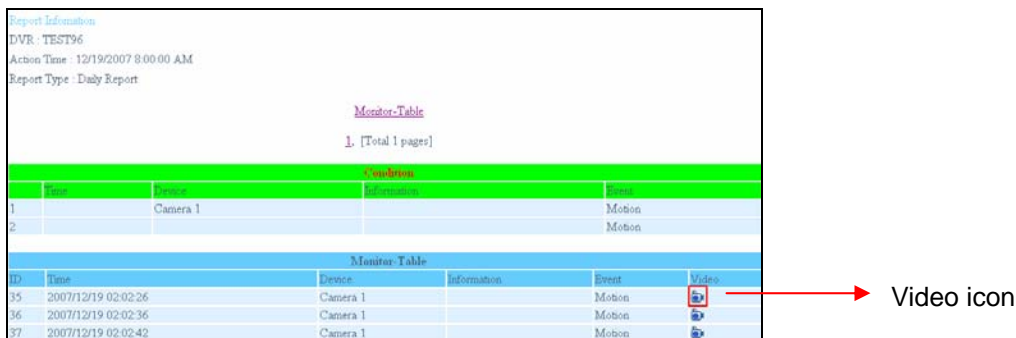

**Figure 10-76**

3. If the **Domain name from DDNS** field on the Advanced Setting tab (Figure 10-71) is not selected, this dialog box will appear.

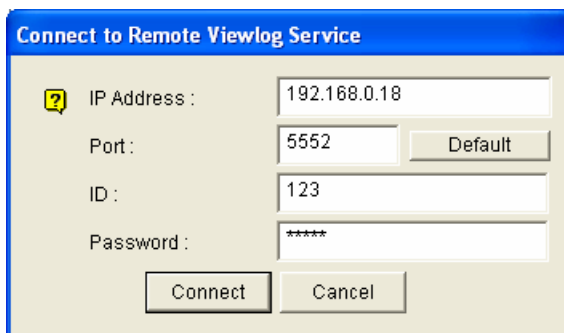

**Figure 10-77**

4. Type the IP or domain name, ID and password of the GV-System, and then click **Connect** for playback.

## Viewing Event Log

All Report Generator events are recorded to the event log. To view the event log, in the Report Generator dialog box, click the **Event Log** tab. All events are displayed in descending order.

For the related settings of the event log, see [Event Log Settings] in Setting Up Report Generator earlier in this chapter.

# Troubleshooting

## Hardware

1. Messages “*Can’t find keypro*” and “*Card Setup Fail*” appears when GV-System starts.
  - Verify the video capture card driver. See *Installation Guide*.
  - Insert the video capture card to a different PCI slot to see if this fixes the problem.
  - If you are using the video capture card V1, attach an appropriate Keypro to the PC’s parallel port and run **Dos2kreg.exe** from the GV-System folder.
  - If using GV-600, GV-650 or GV-650 and running the version between 7.0 and 7.0.5.0, you may need an appropriate USB dongle.
  - If running the version of 8.0 or later and using GV-250, GV-600 V4, GV-650 V4, GV-800 V4, GV-1120, GV-1240, GV-1480, GV-2004 or GV-2008, you may follow Steps 1 and 2 to fix the problem.
  
2. A message “*Video Lost*” appears.
  - Check video connection.
  - Make sure the video device is turned on.
  - Make sure the video standard in your country matches the setting in GV-System (See *Choosing Video Source* in Chapter1).
  - Check AGC setting (See *Adjusting Video Attributes* in Chapter 1).
  - Switch the cable from the functional channel to the non-functional channel, and vice versa. If the previously non-functional channel is now able to deliver video, check the video device itself and its related cables.
  
3. A message “*Can’t find new xxx Module:1, Address:1, in Com1*” appears.
  - Check the RS-485 or USB connection between the GV-System and the GV I/O device.
  - Check whether the power adapter is properly attached to the GV I/O device.
  - Check whether the Port and Address settings on the I/O Devices tab in the System Configure dialog box are correct.
  
4. A message “*No PTZ Device Installed*” or “*Default PTZ Device not Activate*” appears.
  - Make sure the Activate option is enabled in Main System. See step 4 of *PTZ Control Panel* in Chapter 1.
  - When multiple PTZ cameras are installed, make sure to activate each PTZ camera individually.

## Software

1. How to upgrade to the latest version?
  - Download the latest version from GeoVision website:  
[http://www.geovision.com.tw/english/5\\_0.asp](http://www.geovision.com.tw/english/5_0.asp)
2. Recycle mode doesn't work, and recording stops.
  - Exit Main System, and run **RepairLog500.exe** from the system folder to fix this problem.
  - Check Properties of the folder used for saving video files. Make sure the **Read Only** option is disabled.
3. Passwords are lost. Cannot access my GV-System.
  - See *Setting Up for Password* in Chapter 1 for details.
4. A message "*Directdraw overlay fail*" appears.
  - Make sure your VGA card meets the GV-System's minimum requirement that is NVIDIA GeForce II MX 32MB.
  - The driver included in your VGA card package may not be the latest and might not support Directdraw. Visit related websites and upgrade your VGA driver to the latest version.
  - Disable the Directdraw feature if you do not wish to upgrade your VGA card or driver (See *Configuring Global Recording Parameters* in Chapter 1).
5. Shifted horizontal lines appears in the 640x480 video image.
  - Enable De-Interlace Render (See *Configuring Global Recording Parameters* in Chapter 1). This feature requires the VGA card of DirectX 9.0. Make sure to upgrade your VGA card driver and DirectX version.
6. Can't invoke hotline alerts.
  - GV-System only supports external modem using Zyxel or Lucent chipset.
  - Make sure Modem Device and Com Port are set up properly (See *[Modem Configure], Configuring Hotline/Network Notification* in Chapter1).
7. A "?" mark appears in the ViewLog's event list window.
  - These files may already been deleted in the previous Recycle run. Exit Main System and run **RepairLog500.exe** under the system folder to remove these files from the database.

8. Unable to play back audio in ViewLog
  - The video you select may not have any audio records.
  - The speaker icon at the lower right corner is not enabled (See Figure 4-1 in Chapter 4).
  - Audio is not available when the playback method is set to Frame by Frame.
  - Audio can only be played back at 1X speed.

## Remote Application

1. Remote View is unable to display video from GV-System.
  - This symptom may appear when Remote View is installed in Windows XP SP1 or later. Windows XP no longer includes Wavelet decoder after Service Pack 1. You may download a Wavelet codec at this link.  
<http://geo-support.dipmap.com:100/remote/waveletcodec.zip>
  - GV-System version 6.0 is not compatible with Remote View version 5.4.0.1 or earlier. Make sure your GV-System and Remote View are both version 6.0 or later.

2. Network ports used in the remote applications:

<b>WebCam</b>		Http = 80 FTP = 21 Command = 4550 Data = 5550 Audio = 6550 Remote Control = 3389 SSL = 443 Mobile = 8866 Mobile RPB = 5511 3G RTSP / TCP = 8554 3G RTP /RTCP UPP = 17300-17380
<b>RemotePlayBack</b>		RPBSvr = 5066
<b>RemoteView</b>		TCPSvr = 3550
<b>VSM</b>		Server = 5610
<b>TwinServer</b>		Server = 9650 Multicast = 19650
<b>TwinDVR</b>		Http = 80 FTP = 21 Command = 4550 Data = 5550 Remote Control = 3389
<b>IP Multicast</b>		DMMCast = 3650
<b>Authentication Server</b>		Server = 3663
<b>SMS</b>		Server = 6886
<b>CenterV2</b>	<b>At DVR subscriber site</b>	Command = 5548 Connection Port = 5545 Data = 5549 Audio = 5546
	<b>At Center V2 site</b>	Center = 5547 Connection = 5551
<b>Dispatch Server</b>		Server = 21112
<b>GeoCenter</b>		Server = 20001
<b>DMIP</b>		FTP = 21
<b>DDNS</b>		Server = 80 and 81
<b>Control Center</b>	<b>At DVR host site</b>	Command Port = 3388 Data Port = 5611 Log Port = 5552
	<b>At Control Center site</b>	Command Port = 3388
<b>TCP Server</b>		Server = 3550
<b>UPnP</b>		TCP/IP = 5200
<b>Wiegand Capture Server</b>		Server = 5612



## WebCam

1. A message "*can't connect to server*" appeared when GV-System is connected.
  - Check ports 4550 and 5550 are enabled in Firewall.
  - Check whether ports 4550 and 5550 are occupied by other applications.
  - Check NAT port mapping is correct.
  - Check whether the dynamic IP address of GV-System is changed.
  - Check Ethernet adapter (ADSL modem must use the PPP/SLIP device).
  - Check whether Web server changes download timing. (Dynamic Lan IP =1 min, Dynamic WAN IP = 5 min)
  
2. Unable to use the two-way audio feature.
  - Check whether port 6550 is available.
  - Check the client PC's sound card driver.
  - This feature requires DirectX 9.0 or later. Perform upgrade if necessary.
  - This feature requires Internet Explorer 6.0 or later. Perform upgrade if necessary.
  - Check GV-System's audio signal by using the Camera / Audio Install function (See *Camera/Audio Install* in Chapter 1).
  
3. Unable to run MPEG4 Encoder Viewer and WebCam RPB.
  - The security level of your IE browser may prevent WebCam components from downloading to your PC. Start IE browser and go to **Tools**, click **Internet Options**, click **Security** and click **Custom Level**. In Active X controls and plug-ins options, select **Enable** or **Prompt**, and then click **OK**. Log in to GV-System again and WebCam components should be downloaded properly.