

User Manual
of
DS-6100-SATA Series Video
Server

Index

CHAPTER 1	INTRODUCTION.....	4
1.1	FUNCTIONS AND FEATURES	4
1.2	COMMON APPLICATION	5
CHAPTER 2	INSTALLATION.....	6
2.1	HARDWARE INSTALLATION	6
2.1.1	Installation steps	6
2.1.2	Installation notice.....	6
2.2	HDD INSTALLATION	6
2.3	PANEL DESCRIPTION.....	7
2.4	THE PIN DEFINITION OF PHYSICAL INTERFACES	8
2.4.1	PIN definition of RS-232 serial interface	8
2.4.2	PIN definition of RS-485 serial interface	10
2.4.3	PIN definition of Ethernet interface.....	10
CHAPTER 3	VIDEO SERVER SETUP	12
3.1	PARAMETER SETUP THROUGH RS-232 SERIAL PORT	12
3.1.1	Hyper Terminal Setup.....	12
3.1.2	Shell Commands under Hyper Terminal.....	15
3.2	VIDEO SERVER HDD FORMAT.....	18
3.3	VIDEO SERVER RECORDING SETUP.....	18
3.4	PTZ CONTROL	18
3.5	REMOTE SETUP VIDEO SERVER PARAMETERS	19
CHAPTER 4	UPGRADE FIRMWARE	20
4.1	USE SHELL COMMAND AND TFTP SERVER	20
4.2	USE CLIENT SOFTWARE TO UPGRADE FIRMWARE.....	23
CHAPTER 5	PPPOE DIALUP OPERATION	26
5.1	USING PPPoE TO ESTABLISH CONNECTION.....	26
5.2	CLIENT ACCESS DVS WHEN USING PPPoE	27
CHAPTER 6	FREQUENT ASK QUESTIONS	29
APPENDIX A	SPECIFICATIONS.....	30
APPENDIX B	GOOD LIST	31
APPENDIX C	CUSTOMER INFORMATION CARD.....	32

Thanks for purchasing the products of Hikvision. If you have any requests or questions, please contact us immediately.

This manual is applicable to DS-6104HCI-SATA & DS-6101HFI-SATA Series Video Server with one SATA HDD interface for local recording.

This manual will be updated on a regular basis without additional specific notice. The updates will be added to the new version of this manual. We will readily improve and update the products or procedures described in the manual.

Chapter 1 Introduction

DS-6100-SATA series video server adopts embedded Linux OS and TI DaVinci processor that is completely independent of PC platform, and efficiently improves system performance. Firmware is burned into the FLASH, making the system more steady and reliable.

The product has the function of compressing the video and audio signal simultaneously into H.264 hardware compression standard; transmitting the compression stream through network; real-time video and audio preview; supports stream protocol (RTP/RTCP), supports IE browser, bi-directional voice talk and multilingual etc. **It also supports one SATA HDD for local recording.**

Notes:

DS-6104HCI-SATA: 4 channels video input and 4 channels audio input, can support 4-ch CIF compression resolution real time, or 4-ch DCIF/2CIF at 4fps per channel, or 4-ch 4CIF at 2fps per channel.

DS-6101HFI-SATA: 1 channel video input and 1 channel audio input, can max support 4CIF compression resolution real time.

If you set the channel frame rate as 4CIF resolution, please set the bit rate as 1.5Mbps above to get the excellent image quality.

The default DS-6104HCI-SATA & DS-6101HFI-SATA are without HDDs.

1.1 Functions and features

➤ Basic Function:

1. Adopt H.264 video compression and OggVorbis audio compression technology;
2. Multiple security level leads to high system safety;
3. Support one RS-485 interface that can be used for controlling pan-tilt-zoom and translucent channel input;

➤ Compression Function

1. DS-6101HFI-SATA supports 4CIF compression resolution real time.
2. DS-6104HCI-SATA can support 4-ch CIF compression resolution real time, or 4-ch DCIF/2CIF at 4fps per channel, or 4-ch 4CIF at 2fps per channel.
3. **Support both variable bit rate and variable frame rate.** When choosing video image quality, you can also limit the bit rate.
4. Support OSD .The position of the date & time can be changeable.
5. Support LOGO, and the position is adjustable in the video image.

➤ Local Recording Function

1. Support multiple record type, including schedule recording, manual recording, motion detection, external alarm, motion&alarm, motion|alarm recording.
2. Support one SATA HDD that can max support 2000GB.

3. Support FAT32 files system
4. Support HDD S.M.A.R.T technology.
5. Support cycle or non-cycle record.

➤ **Network Function**

1. Support one 10M/100M adaptive NIC;
2. Support TCP/IP protocols; support video, audio, alarm, voice data, serial device data transmission through TCP/IP network; build-in WEB browser, support IE access.
3. Support pan-tilt-zoom control such as the turn of PTZ, iris and focus;
4. Support remote upgrade and maintenance;
5. RS-485 interface supports transparent channel, through which the remote host can control serial devices.

1.2 Common application

Network digital surveillance, such as factory and the bank etc;

Remote monitoring service for prison, nursery and school;

Intelligent gate system (dynamic record the people in and out);

Intelligent building and community;

Self-service system of electric power station or telecom base station;

Outdoor equipment monitoring;

Bridge, tunnel and cross road-monitoring system;

Pipeline, warehouse monitoring;

24 hour monitoring of traffic;

Remote monitoring of forest, water and river etc

Chapter 2 Installation

2.1 Hardware installation

2.1.1 Installation steps

1. Open packing case, and check the integrity;
2. Take out things needed in installation;
3. Connect cables needed (video signal input cable, audio signal input cable, RS485 cable and cable for LAN);
4. Take out stabilizer power supply and power on.

2.1.2 Installation notice

Please read the following notice carefully. If you have any question, please contact us.

Notice:

1. After Opening the packing box, please check carefully to confirm that the goods in it are consistent with list;
2. Please read user's manual carefully before installation;
3. Please power-off all related equipments before installation;
4. Please check the voltage of power supply to avoid voltage mismatch;
5. Installation environmental: Do not use it under humidity and high temperature; to keep ventilation to vent freely, avoid to be walled up; to keep them horizontally, avoid setting up in the vibration surroundings.

2.2 HDD Installation

Installation notice

The DS-6100-SATA has no HDD when leaving factory. Based on the record schedule, you can calculate the total capacity you need (refer to Appendix A). Please ask the specialist to disassembly the video server and install HDD.

Installation instrument

One cross screw driver

HDD installation

1. Open the video box.
2. Place the HDD in the proper space and fix it with screw.

3. Connect the SATA data cable correctly.
4. Plug the HDD power connector.
5. Cover and fix the video server box.

Note: After you install the HDD, you must format it. You can use remote client software to format the HDD.

2.3 Panel description



Front panel

Interface Instruction (From left to right in turn)

1. HDD indicator lamp;
2. Tx/Rx indicator lamp;
3. Link indicator lamp;
4. Power supply indicator lamp;

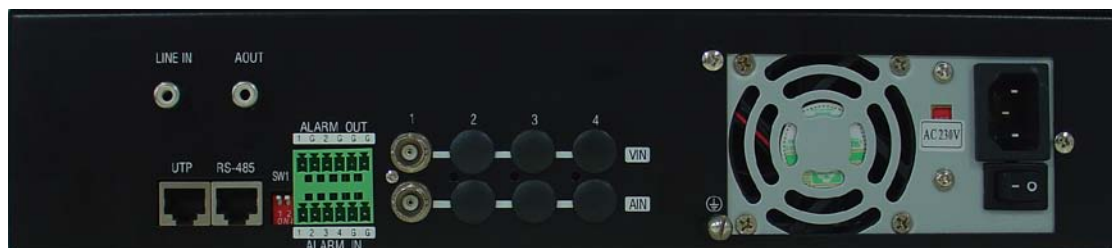

Back panel of DS-6101HFI-SATA

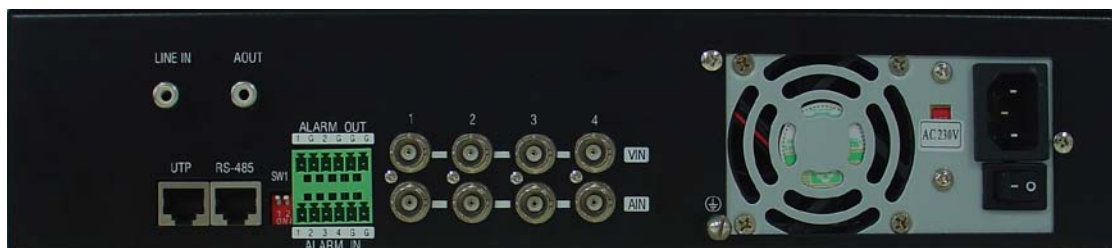

Back panel of DS-6104HCI-SATA

Interface Instruction (From left to Right in return):

1. One line in audio input for voice talk.

2. One audio output for voice talk.
3. One RJ45 UTP network port and one RJ45 RS-485 PTZ port.
4. 4 external alarm input and 2 relay output.
5. 4 channels video input and audio input.
6. Power supply adapter.

2.4 The pin definition of physical interfaces

2.4.1 PIN definition of RS-232 serial interface

The DVS has one RS-232 standard serial interface, with RJ-45 connector. Its pin definition is as follows ('I' means input, and 'O' means output):

Table 2.1 Pin definition of RS232 serial port

Pin No	Neme	I/O	Explanation
1	DCD	I	Carrier Detect
2	RxD	I	Receive
3	TxD	O	Transmit
4	CTS	I	Clear send
5	RTS	O	Request to send
6	DTR	O	Data Terminal Ready
7	GND		GND
8			

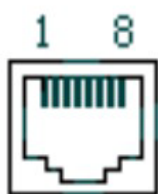
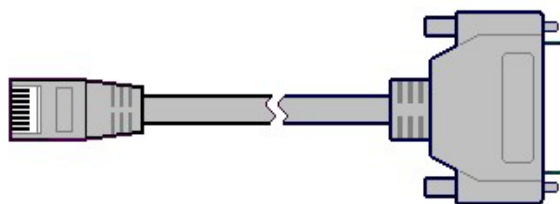
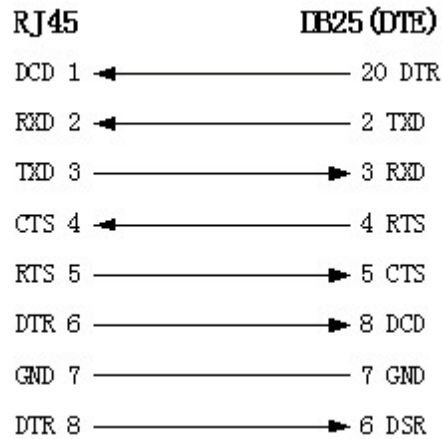

Fig 2.1 RJ-45

(1) When the RS232 interface of the DVS connects with the DTE equipment, one end of the cable is the 8-pin RJ45 connector (to DVS) and the other of the cable is the DB25 female connector (to DTE). Below is the description of the internal connection between RJ45 and DB25.





(2) 25-pin to 9-pin converter's internal connection is like this:

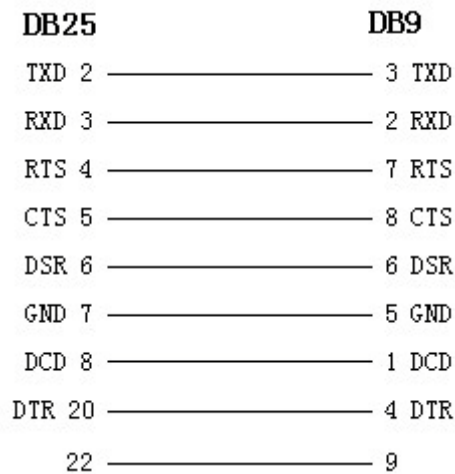

(3) If you don't want to use 25-pin to 9-pin convertor to connect DVS and DTE through RS232 interface, you must use RJ45-DB9 cable. Its internal connection description is:

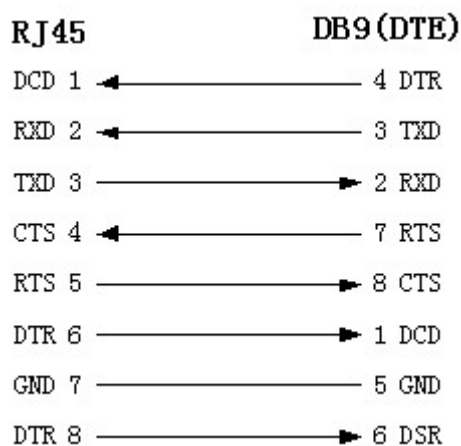

(4) When the RS232 interface of the DVS connects with the DCE (such as MODEM), one end of the cable is the 8-pin RJ45 connector and the other is the DB25 male connector. Below is the description of the internal connection between RJ45 and DB25:

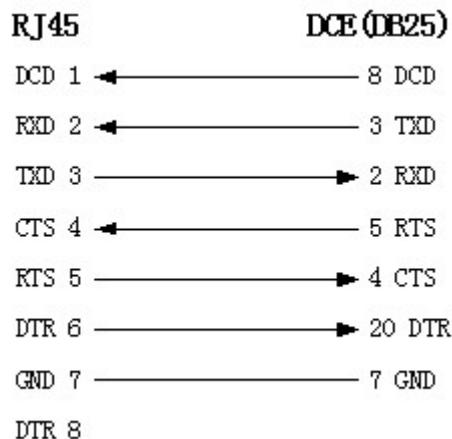

2.4.2 PIN definition of RS-485 serial interface

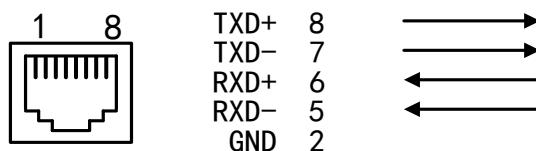

2.4.3 PIN definition of Ethernet interface

(1) PIN definition of the direct network cable connecting DVS and HUB:

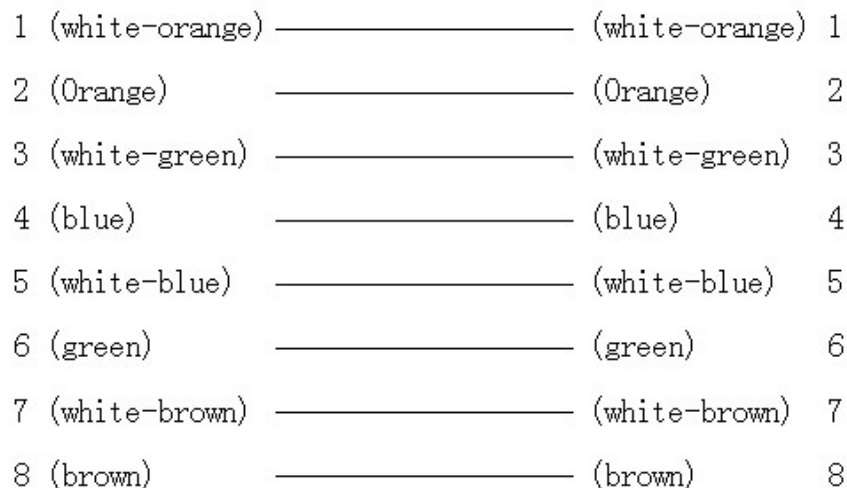

(2) PIN definition of the cross network cable connecting DVS and host PC:

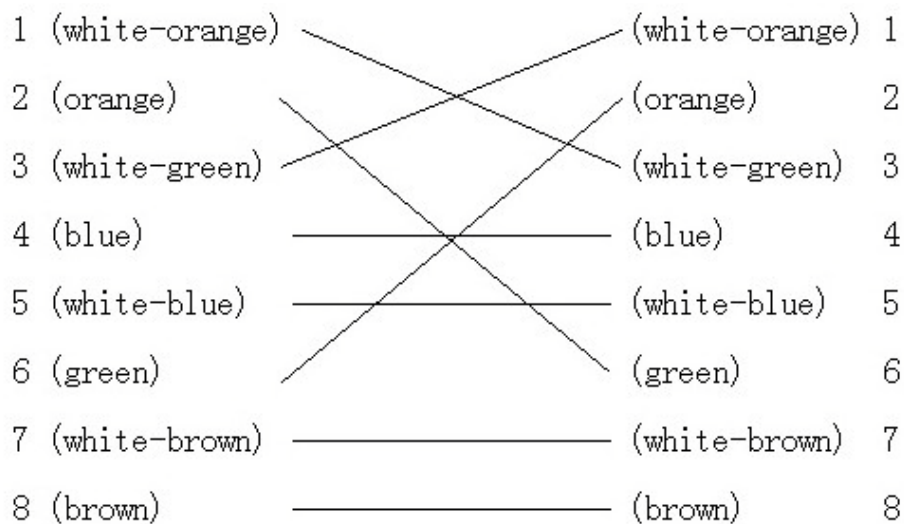

Chapter 3 Video Server Setup

There are three kinds of methods to configure the parameters of video server.

1. Through Hyper Terminal (connect DVS with the PC through RS-232 serial ports)
2. Through client-end application software (connect DVS with PC through network)

3.1 Parameter Setup through RS-232 serial port

Mainly set up IP parameters of the video server through serial port. The default IP address is 192.0.0.64.

Under the case that the IP address is unknown; the Hyper Terminal or NetTerm (need to connect the serial ports) can be adopted to get or configure IP address and subnet mask. Under the case that IP address is known, client software can be adopted to configure IP address and other parameters.

3.1.1 Hyper Terminal Setup

Please direct connect the RS-232 serial port of PC with the RS-232 serial port of video server before configuration (there are RJ45 head and DB9 line in the packing carton)

How to establish the connection with the super terminal connection?

Step one: Enter into Hyper Terminal. Click “Start” → “Programs” → “Accessories” → “Communications” → “Hyper Terminal” in Windows system, and the dialogue box below will appear (Fig. 3.1):



Fig. 3.1 Newly establish a connection and define the name and icon

Step2: To name the connection name and to define the icon. Input a name (e.g. aa), select a icon, press “OK”, the dialogue box like Fig. 3.2 appears.



Fig. 3.2 Select communication port

Step 3”: to select the communication port. Select “com1” communication port in Fig3.2, press “OK”, the dialogue box as Fig. 3.3 will appear.

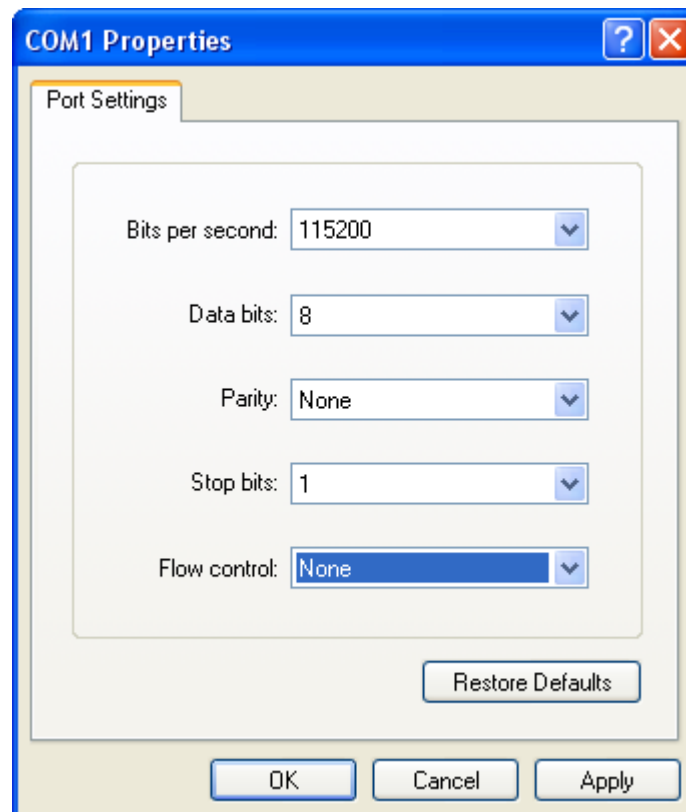

Fig. 3.3 Serial ports parameter setup

Step 4: Serial port parameters setup. Set the serial port parameters as the following setup: Bits per second: 115200, Data bits: 8, Parity: None, Stop bits: 1, Flow control: None. Press “OK” after finish, the Hyper Terminal interface like Fig. 3.4 will appear

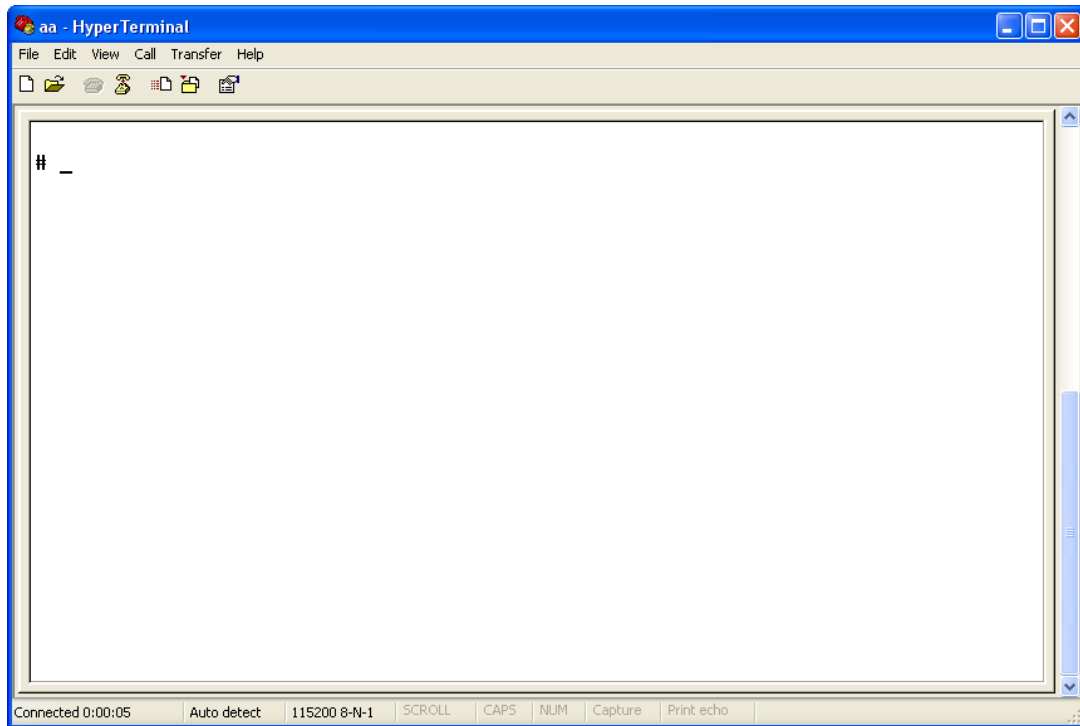

Fig. 3.4 Hyper Terminal Interface

Step 5: To close the window, the Fig. 3.5 will appear. Select “Yes” and Fig. 3.6 will appear:

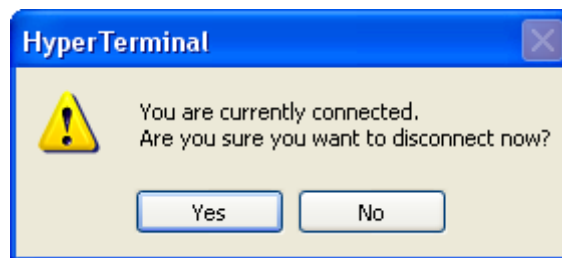

Fig. 3.5 Disconnect

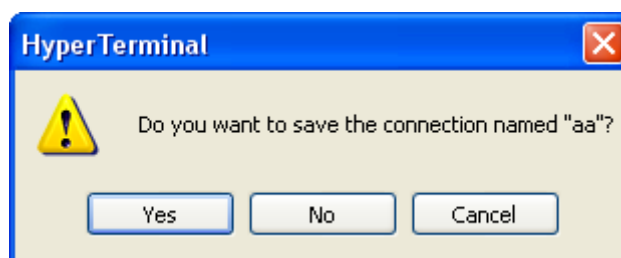

Fig. 3.6 Save Hyper Terminal session

Step 6: Save the Hyper Terminal session for using next time. After saving, it will new establish a “Hyper Terminal” item in the program group “Start” → “Programs” → “Accessories” → “Communications” → “Hyper Terminal” and it includes all “Connection” name for all Hyper Terminal. Here you have see “aa.ht”.

3.1.2 Shell Commands under Hyper Terminal

Please use the DTE cable and the DB9/DB25 convertor to connect PC with DVS RS-232 port.

Step 1: Enter into the Hyper Terminal. Click “Start”→ “Programs”→ “Accessories”→ “Communications”→ “Hyper Terminal”→ “aa.ht”, the Hyper Terminal interface in Fig. 3.4 will appear.

Step 2: Press “Enter” in Hyper Terminal, the prompt “#” appear, as in Fig. 3.7. Under this prompt the following operation commands to accomplish the setup of the parameters.

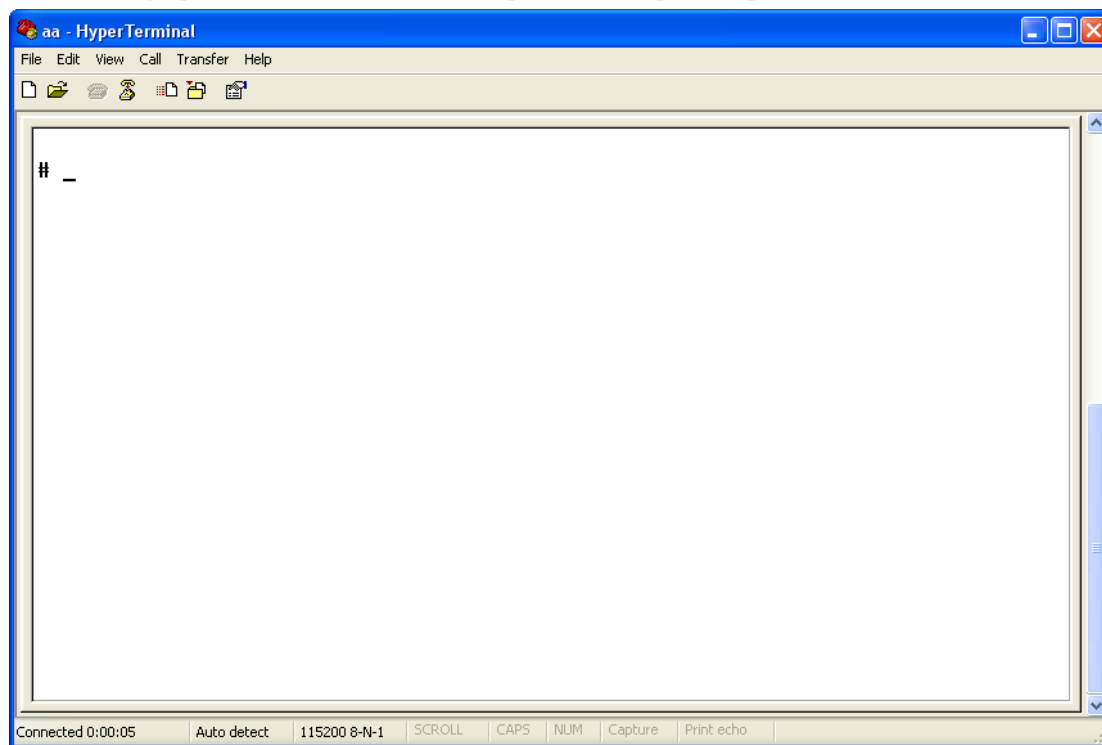
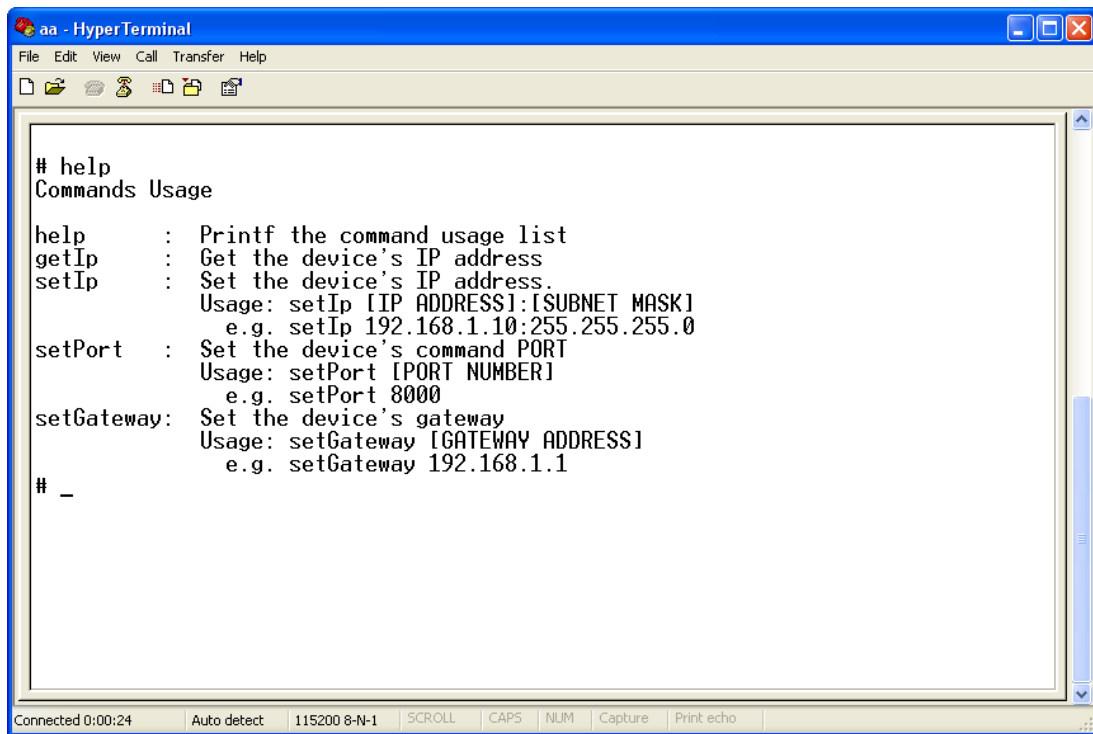

Fig. 3.7 Hyper Terminal command prompt

Input help, the supported configuration commands can be checked up, as in Fig. 3.8.



```
# help
Commands Usage

help      : Printf the command usage list
getIp     : Get the device's IP address
setIp     : Set the device's IP address.
           Usage: setIp [IP ADDRESS]:[SUBNET MASK]
           e.g. setIp 192.168.1.10:255.255.0
setPort   : Set the device's command PORT
           Usage: setPort [PORT NUMBER]
           e.g. setPort 8000
setGateway: Set the device's gateway
           Usage: setGateway [GATEWAY ADDRESS]
           e.g. setGateway 192.168.1.1
# _
```

Fig. 3.8 Check command

The following is the introduction of getIp, setIp commands.

getIp

Function: get the fixed IP, subnet mask, gateway, command port, IP address of PPPoE dialup (the IP address of PPPoE will be 0.0.0.0 if there is no dialup or dialup is not successful).

Parameter: none.

Grammar format: Enter after input the command

Explanation: Please pay attention whether the inputting letters are capital or low case.

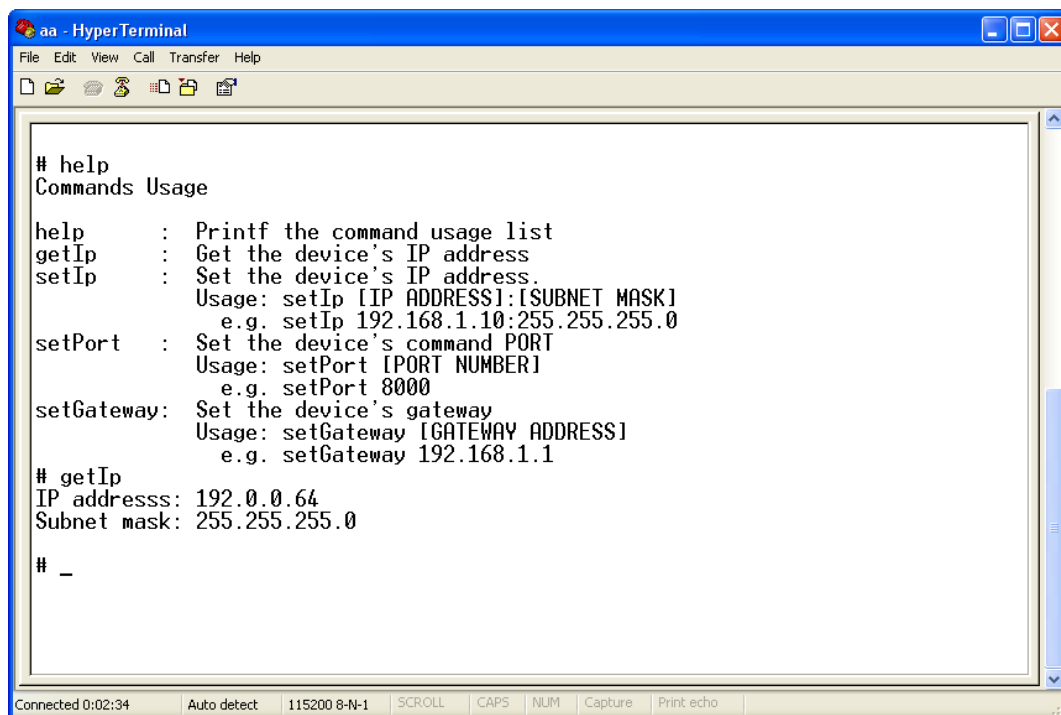

```
aa - HyperTerminal
File Edit View Call Transfer Help

# help
Commands Usage

help      : Printf the command usage list
getIp     : Get the device's IP address
setIp     : Set the device's IP address.
           Usage: setIp [IP ADDRESS]:[SUBNET MASK]
           e.g. setIp 192.168.1.10:255.255.255.0
setPort   : Set the device's command PORT
           Usage: setPort [PORT NUMBER]
           e.g. setPort 8000
setGateway: Set the device's gateway
           Usage: setGateway [GATEWAY ADDRESS]
           e.g. setGateway 192.168.1.1

# getIp
IP addresss: 192.0.0.64
Subnet mask: 255.255.255.0

# _

Connected 0:02:34  Auto detect  115200 8-N-1  SCROLL  CAPS  NUM  Capture  Print echo
```

Fig. 3.9 Get parameters of IP, PPPoE

setIp

Function: set the IP, subnet mask and gateway of the device

Parameter: IP address, subnet mask, gateway

Grammar format: setIp IP: mask

Explanation: Please pay attention whether the inputting letters are capital or low case. And separate the parameters by colons.

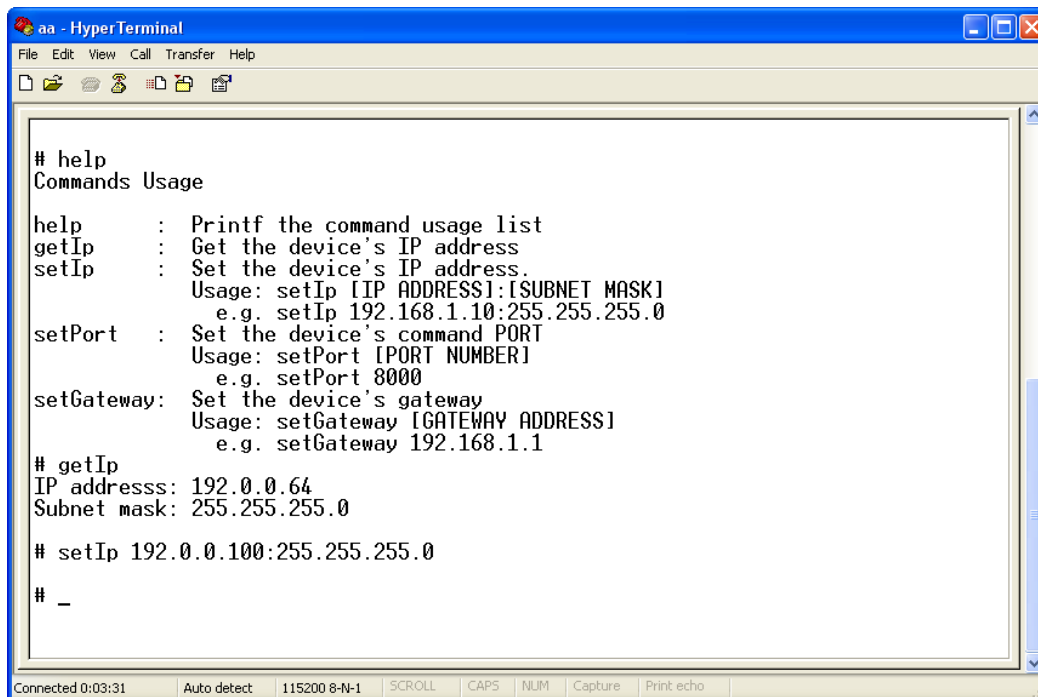

```
aa - HyperTerminal
File Edit View Call Transfer Help

# help
Commands Usage

help      : Printf the command usage list
getIp     : Get the device's IP address
setIp     : Set the device's IP address.
           Usage: setIp [IP ADDRESS]:[SUBNET MASK]
           e.g. setIp 192.168.1.10:255.255.255.0
setPort   : Set the device's command PORT
           Usage: setPort [PORT NUMBER]
           e.g. setPort 8000
setGateway: Set the device's gateway
           Usage: setGateway [GATEWAY ADDRESS]
           e.g. setGateway 192.168.1.1

# getIp
IP addresss: 192.0.0.64
Subnet mask: 255.255.255.0

# setIp 192.0.0.100:255.255.255.0

# _

Connected 0:03:31  Auto detect  115200 8-N-1  SCROLL  CAPS  NUM  Capture  Print echo
```

Fig. 3.10 Set IP

3.2 Video Server HDD format

Please refer to chapter 3.1 to get video server IP address. Then use remote client software to access video server. Please refer to client software user manual for detail information.

3.3 Video Server Recording Setup

Please use remote client software to remote setup video server local recording parameters.

3.4 PTZ control

Step1: Connect DS-6100-SATA RS-485 interface with PTZ. Please refer to RS-485 pin definition. DVS just uses Pin8 (TX+) and Pin7 (TX-) to send PTZ control command.

Step2: You can use remote client software to setup PTZ protocol.

In client software remote “Local Configure” dialog box, select “COM configuration” tab button. You can select DVS PTZ parameters in the corresponding dialog box.

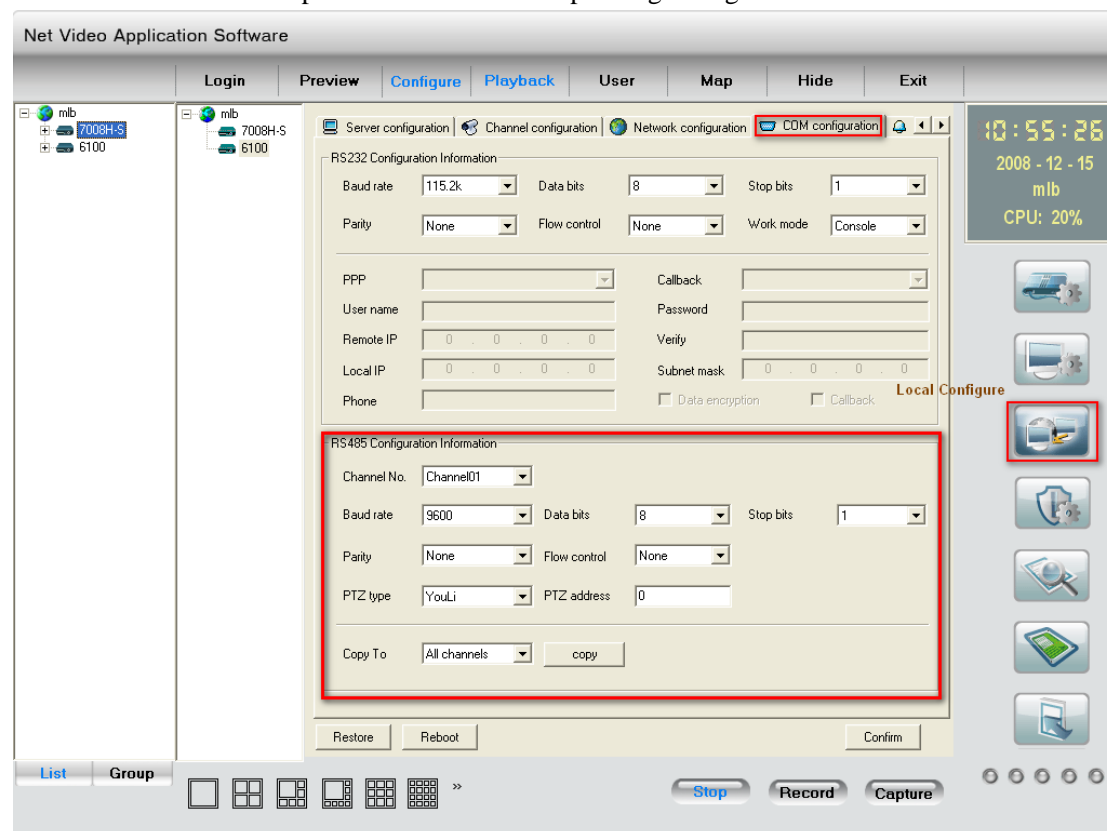

Fig. 3.11 RS-485

Please refer to client software user manual for detail information.

3.5 Remote setup video server parameters

Before the configuration, please make sure that the PC and the video server has been established the network connection, you can confirm using PING command. Please refer to the user manual of DVRDVS client software for detail information.

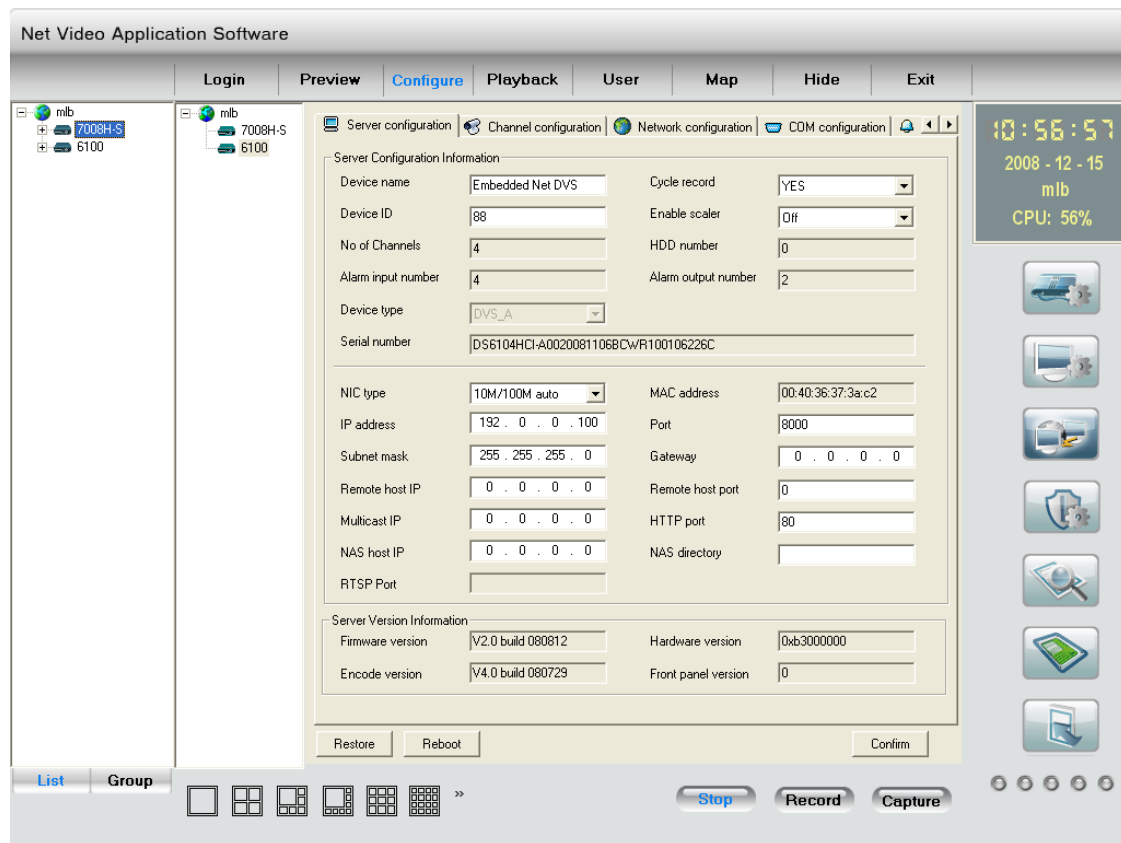

Fig.3.12 Server Configuration

Chapter 4 Upgrade Firmware

There are two methods to upgrade the DVS firmware. One is using shell commands to ask DVS to download firmware from TFTP server. The other is using PC client software.

4.1 Use Shell Command and TFTP Server

Step 1:

Before the update start you should do the follow steps:

1. Download the TFTP server from the internet, such as Cisco TFTP Server. Then put the firmware in the root directory of the Cisco TFTP Server.
2. Connect the device to the Router.
3. Please use DTE cable to connect device 232 port with COM port of the server PC.
4. Configure the Hyper Terminal. Steps as below.

Enter into start----all programs----accessories-----communications-----hyper terminal. Click hyper terminal.

- 1) Input the name “aa”. And do the step 1 again. Then enter into Fig 4.2. Select COM1 and click “OK” to enter into Fig 3.



Fig 4.1



Fig 4.2

- 2) Modify the bits per second to ‘115200’. and modify the flow control to ‘None.’ Finally click “apply” and “ok” to enter into the hyper terminal main interface.

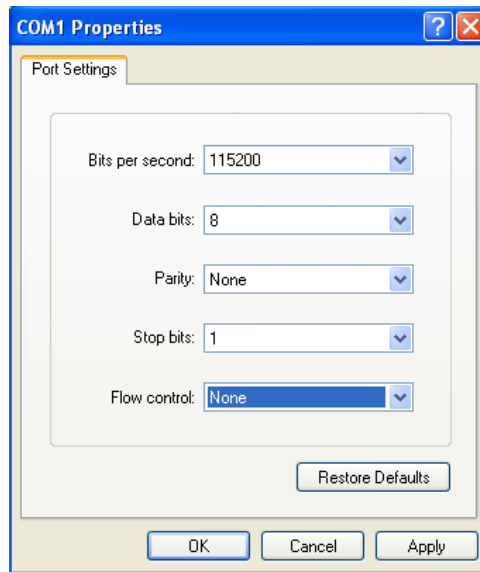

Fig 4.3

Step 2:

Then reboot the device and press any button in the pc keyboard again and again until the HIK # come out in the Hyper Terminal interface, show as Fig 4.4. Then input the “print” to check if the IP of the server and device is correct, also both of them should be in the same LAN. you can use the command

“set serverip” to modified the server ip

“set ipaddr” to modified the device ip

“set netmask” to modified the mask ip

Show as the Fig.4.5.

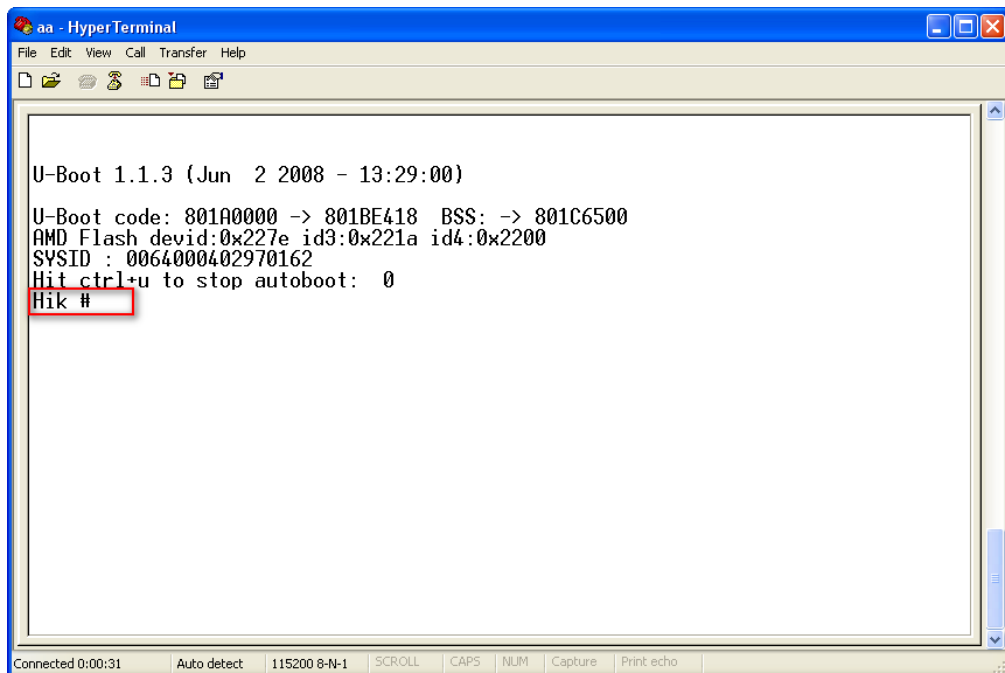

Fig 4.4

```

aa - HyperTerminal
File Edit View Call Transfer Help

U-Boot 1.1.3 (Jun  2 2008 - 13:29:00)
U-Boot code: 801A0000 -> 801BE418 BSS: -> 801C6500
AMD Flash devid:0x227e id3:0x221a id4:0x2200
SYSID : 0064000402970162
Hit ctrl+u to stop autoboot:  0
Hik # set serverip 192.0.0.1
Hik # set ipaddr 192.0.0.64
Hik # set netmask 255.255.255.0
Hik # save
Saving Environment to Flash...
<yxq_info> the config command is 0x1e0!
Not using the addr redund env!
Un-Protected 1 sectors
Erasing Flash...
Erase Operation Completed.
Erased 1 sectors
Writing to Flash...to addr 0x2020000 len 0x10000-done
Protected 1 sectors
Hik # _

Connected 0:02:52  Auto detect  115200 8-N-1  SCROLL  CAPS  NUM  Capture  Print echo

```

Fig 4.5

Step 3:

Input command “save” and press enter button. Show as Fig.4.5.

Step 4:

Input the command “update” and press enter button, then space button. After that the update will start. Show as Fig.4.6

```

aa - HyperTerminal
File Edit View Call Transfer Help

Hik # set netmask 255.255.255.0
Hik # save
Saving Environment to Flash...
<yxq_info> the config command is 0x1e0!
Not using the addr redund env!
Un-Protected 1 sectors
Erasing Flash...
Erase Operation Completed.
Erased 1 sectors
Writing to Flash...to addr 0x2020000 len 0x10000-done
Protected 1 sectors
Hik # update
Update flash.
*****
* ATTENTION!! PLEASE READ THIS NOTICE CAREFULLY! *
* don't reset machine,or anything that interrupt it *
* if this program fails,machine might be unusable, *
* and you will need to reflash again. *
* if you find this too risky,power off machine now. *
* or press the SPACE key now to start. *
*****

This program will update digicap.dav.
_

Connected 0:03:20  Auto detect  115200 8-N-1  SCROLL  CAPS  NUM  Capture  Print echo

```

Fig. 4.6

Step 5:

After the update finished, please input the command “reset” and press the enter button. The device will reset. Show as Fig.4.7.

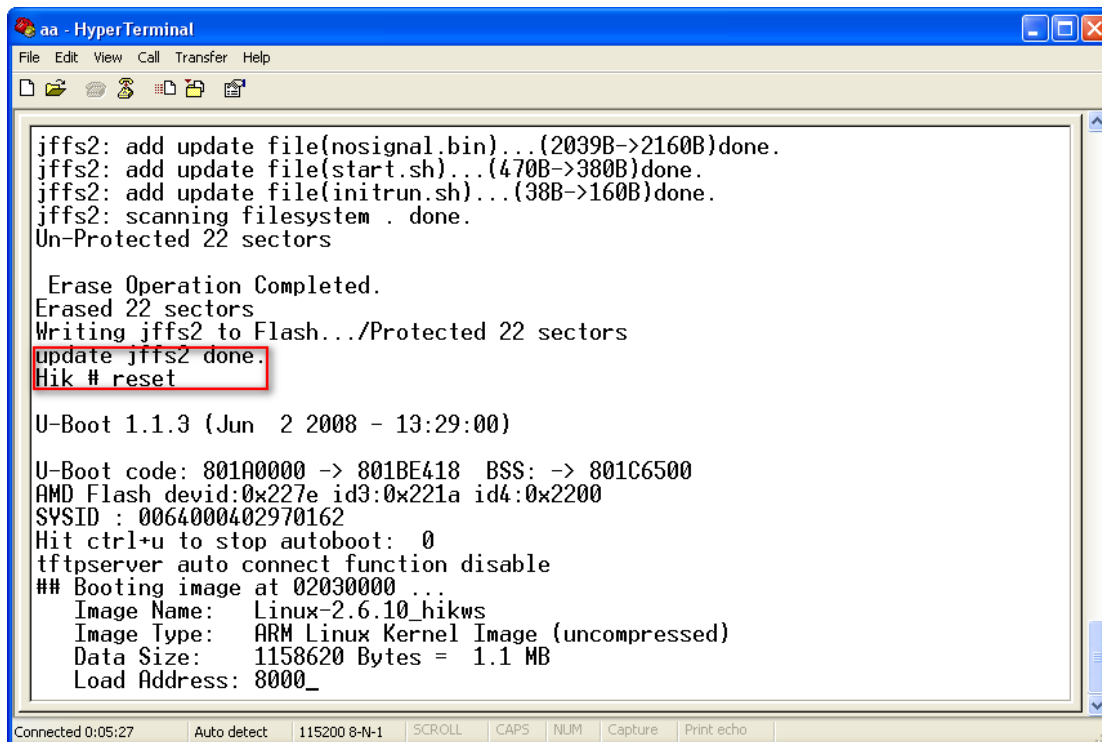
The image shows a HyperTerminal window titled "aa - HyperTerminal". The window contains the following text output from a device:

```
jffs2: add update file(nosignal.bin)...(2039B->2160B)done.
jffs2: add update file(start.sh)...(470B->380B)done.
jffs2: add update file(initrn.sh)...(38B->160B)done.
jffs2: scanning filesystem . done.
Un-Protected 22 sectors

Erase Operation Completed.
Erased 22 sectors
Writing jffs2 to Flash.../Protected 22 sectors
update jffs2 done.
Hik # reset

U-Boot 1.1.3 (Jun  2 2008 - 13:29:00)

U-Boot code: 801A0000 -> 801BE418 BSS: -> 801C6500
AMD Flash devid:0x227e id3:0x221a id4:0x2200
SYSID : 0064000402970162
Hit ctrl+u to stop autoboot: 0
tftpserver auto connect function disable
## Booting image at 02030000 ...
Image Name:   Linux-2.6.10_hikws
Image Type:   ARM Linux Kernel Image (uncompressed)
Data Size:   1158620 Bytes = 1.1 MB
Load Address: 8000_
```

The text "update jffs2 done." and "Hik # reset" are highlighted with a red rectangular box. At the bottom of the window, there is a status bar with the text "Connected 0:05:27", "Auto detect", "115200 8-N-1", "SCROLL", "CAPS", "NUM", "Capture", and "Print echo".

Fig 4.7

4.2 Use Client Software to upgrade firmware

In the system setup dialog of DVRDVS client software (refer to client software user manual), there is a button named “Other”:

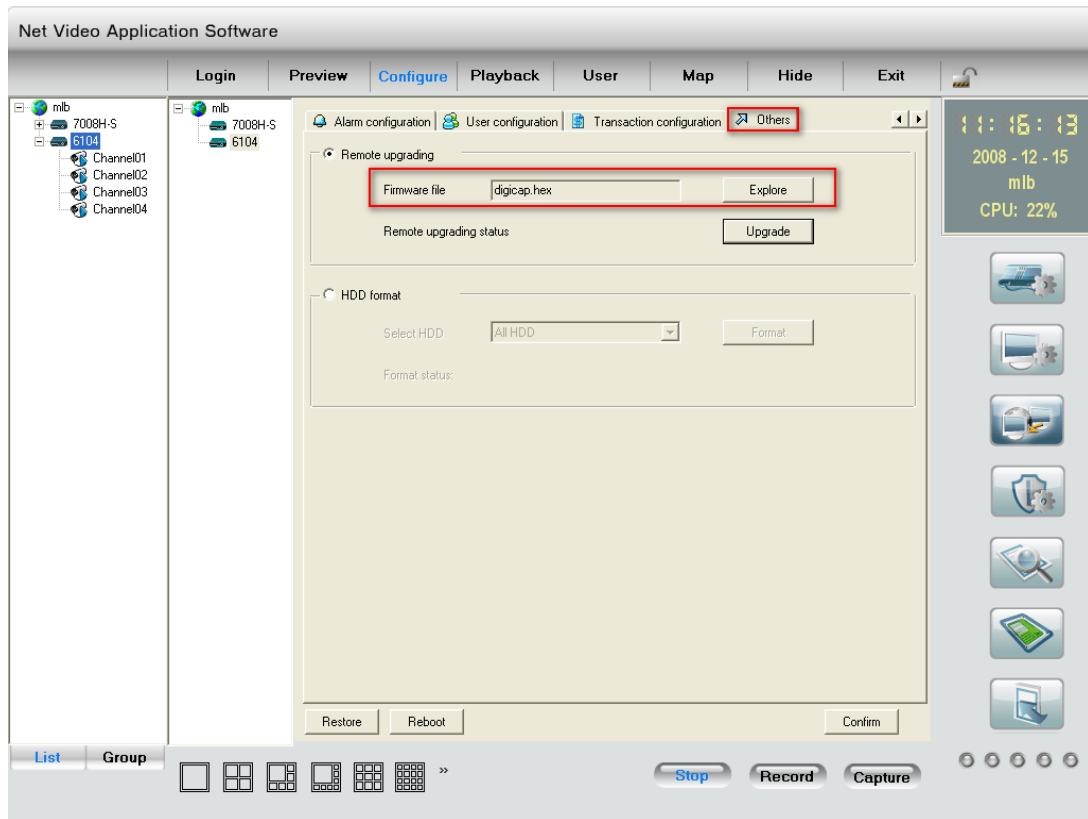

Fig.4.8 Remote upgrading

Click “Explore” button and select the firmware file.

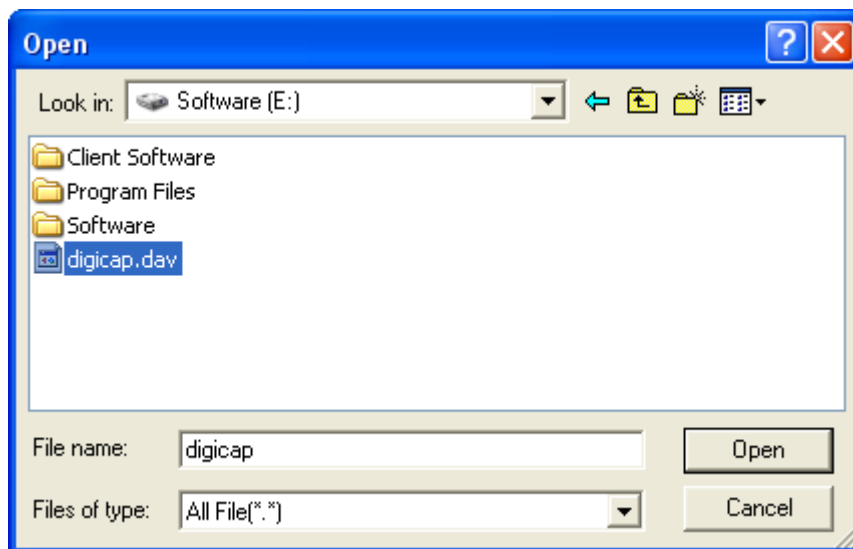

Fig.4.9

Then click “Upgrade” button, to complete the upgrading process of the video server firmware.

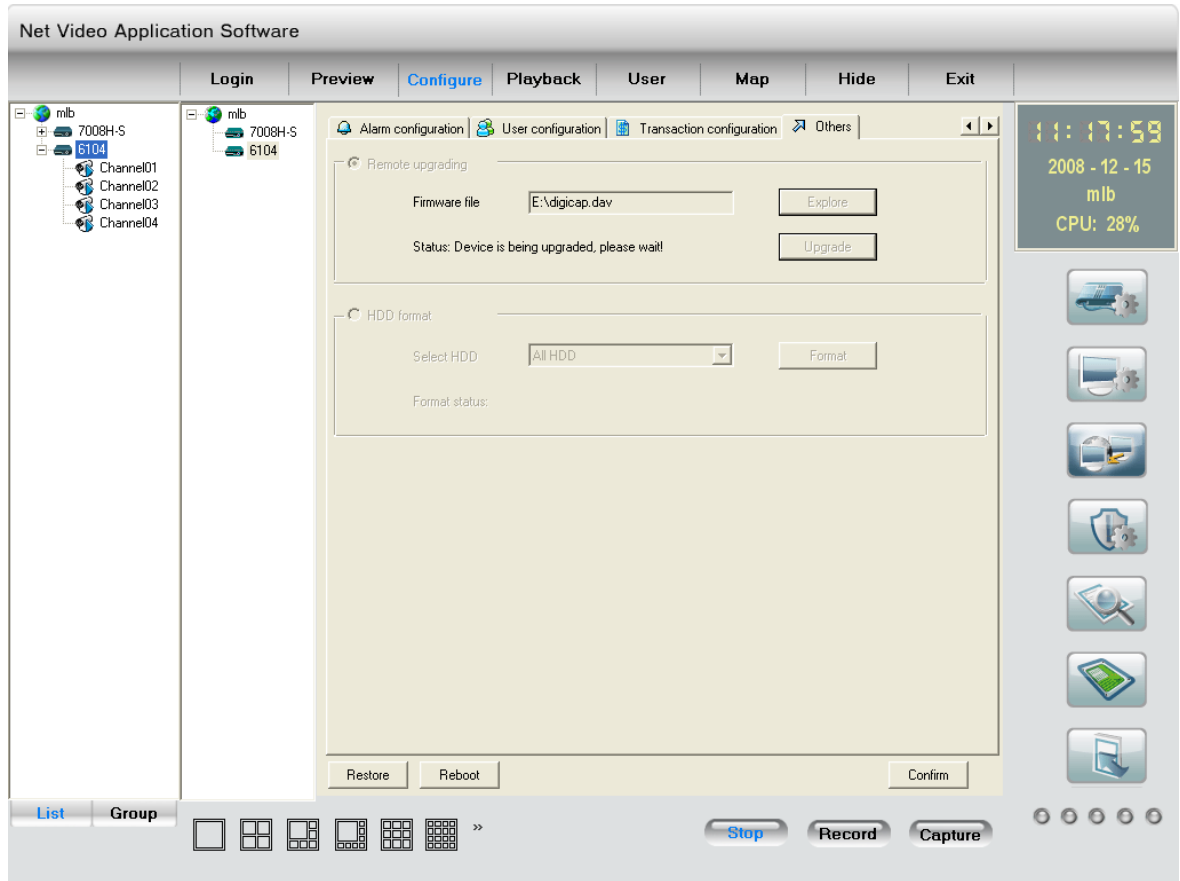

Fig.4.10

Chapter 5 PPPoE Dialup Operation

DS-6100-SATA video server supports remote access through network, through browser, through PPPoE or PPP dialup. Before using this function, please make sure that the software you used in your device support such functions or not.

5.1 Using PPPoE to establish connection

In the local LAN, use the client software remote setup the DVS parameters. The setup dialog is looked as following:

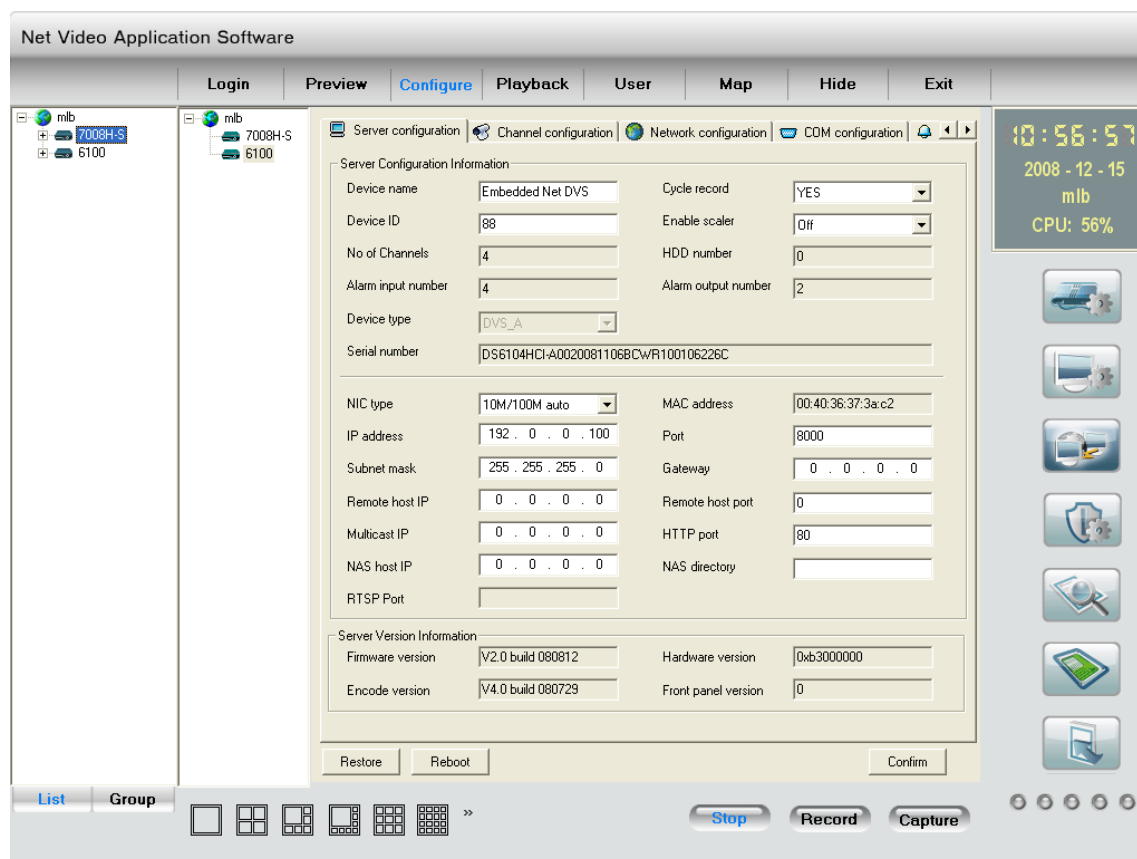

Fig.5.1

In the server parameters sub dialog, enable PPPoE function, input the correct PPPoE user name and PPPoE password. Click “Confirm” button and “Save Para.” button. The new server parameters will be saved into video server through network. Reboot the video server, the DVS will start to dialup the internet. After success, the video server will get a dynamic WAN IP address.

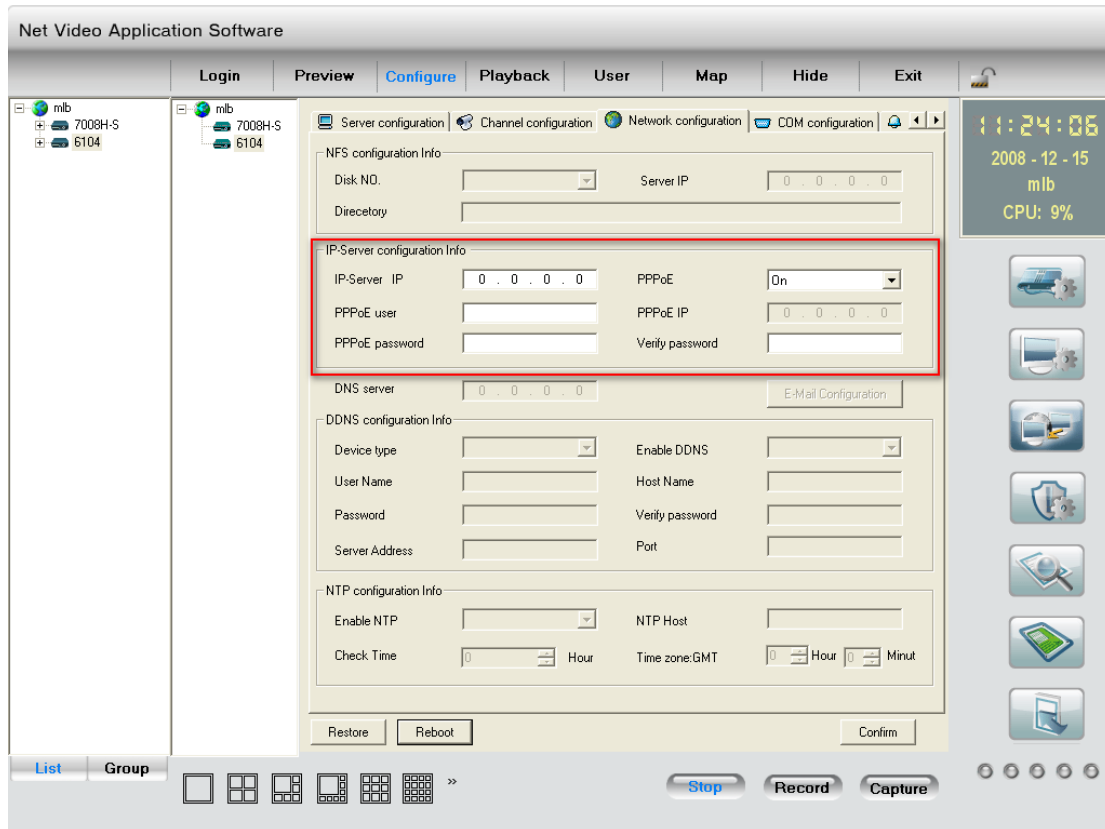

Fig.5.2

[Explanation] please make sure that ADSL Modem is installed. If it is the first time to set PPPoE parameters, it needs to reboot video server to establish the connection.

5.2 Client access DVS when using PPPoE

There are two methods:

One is to access using the current WAN IP address of the video server.

When the video server is successful establish the network connection by using PPPoE mode, it will get the WAN IP address. You can use Hyper Terminal to get the WAN IP address, and access this IP address through client software.

The other is to access through domain analysis server. By using this mode, you need a PC with a fixed WAN IP address in the Internet, and there is the domain analysis server software running in this PC (actually this PC is the analysis server). We provide such demo DNS software and SDK.

In the server parameters of video server, there is an item named DNS. Please input the PC fixed WAN IP address here. When the video server is successfully connection with the internet by using PPPoE, it will get a dynamic WAN IP address, and send the name and current IP address to the analysis server. If the client-end software wants to access the video server, it'd first to connect with the PC used as the analysis server, telling the analysis server which one video server he wants to access. The analysis server will search all the video servers have been registered, find out the server with the same name or same serial number, and tell the client-end the WAN IP address of the video server. After the client-end software get the current IP address, it can establish

the network connection with the video server to get the video images directly.

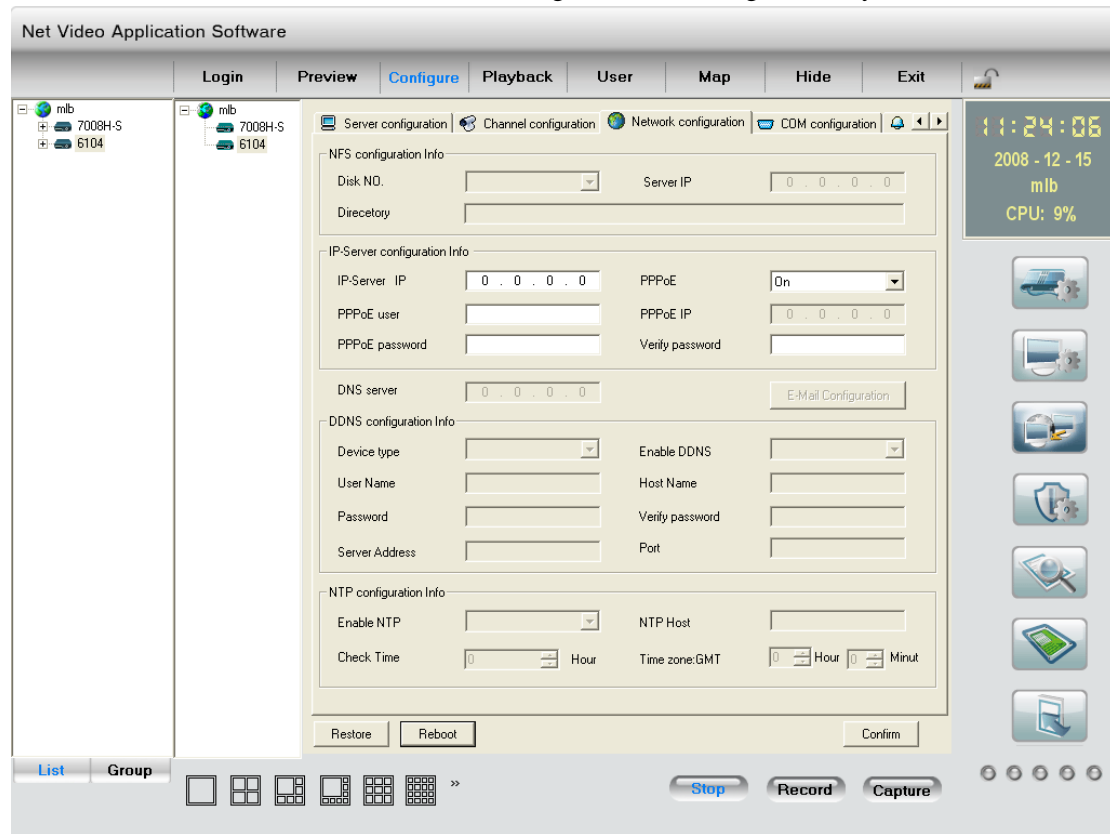

Fig.5.3

Here the fixed WAN IP address of PC is 220.184.114.48. We call it as DNS IP. In that the PC, one demo analysis server software named IP Server is run. It can get the video server information, including the dynamic WAN IP address of the video server.

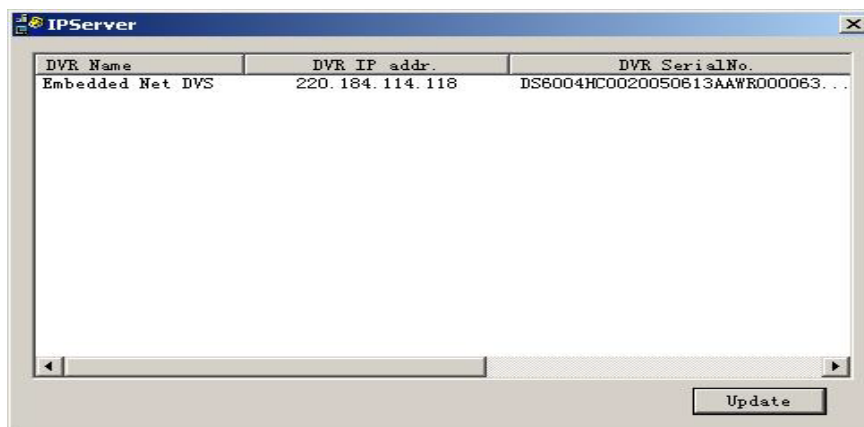

Fig.5.4

Chapter 6 Frequent Ask Questions

1. Failure to control PTZ

It is possible that the camera and equipment are not connected through RS485 port, or the wrong configuration of the decoder.

2. certain individual channel picture is un-normal

Please check whether the video cable is well connected with the camera and the Embedded DVS

3. Possible reasons which can cause the failure of upgrading

Failure of the network, IP address error in the TFTP host computer, TFTP service is not been booted by PC, the path to upgrade is not correct; no permission (usually happened when to upgrade through client-end.)

If the above information cannot meet your demand, please not hesitate to contact the provider.

Appendix A Specifications

Model	DS-6101HFI-SATA	DS-6104HCI-SATA
Video compression	H.264	
Preview resolution	4CIF (PAL: 704*576, NTSC: 704*480)	
Recording resolution	4CIF/DCIF/2CIF/CIF/QCIF	
Support dual stream	Yes	
Video input	1	4
Video input interface	BNC(1.0Vp-p, 75Ω), Support PAL, NTSC	
Frame rate(per channel)	4CIF real time	4-ch 4CIF at 2fps
		or 4-ch DCIF/2CIF at 4fps
		or 4-ch CIF real time
Stream types	Video/Video & Audio	
Bit rate	32Kbps ~ 2Mbps adaptive (max 8Mbps)	
Audio input	1	4
Audio input interface	BNC (2.0~2.4Vp-p, 1kΩ)	
Audio output	1 channel RCA(2.0~2.4Vp-p, 600Ω)	
Audio compression	OggVorbis, 16Kbps	
Voice talk	1 channel RCA (2.0~2.4Vp-p, 1kΩ)	
Communication interface	1 RJ45 10M/100M Adaptive Ethernet port, 1 RS232 interface and 1 RS485 interface	
SATA interface	1 interface for 1 SATA hard disk, the max capacity is 2000GB	
Alarm input	4	
Alarm output	2	
Power supply	220VAC, 47~63Hz	
Power consumption	≤40W (without HDD)	
Working temperature	-10℃~+55℃	
Working humidity	10%~90%	
Size	78mm(H)*350mm(W)*222mm(D)	
Weight	≤5Kg(without HDD)	

PAL: 176×144(QCIF), 352×288(CIF), 704×288(2CIF), 528×384(DCIF), 704×576(4CIF);

NTSC: 176×120(QCIF), 352×240(CIF), 704×240(2CIF), 528×320(DCIF), 704×480(4CIF).

Appendix B Good list

1. One piece of DS- 6100-SATA video server;
2. One CD contains client application and user manual;
3. One power cable;
4. One DTE cable;

Appendix C Customer Information Card

User's Name	Mr./Mrs.
Company Name	
Post Address	
Postcode	
Phone Number	
E-mail	
Model Number of Product	
Serial Number of Product	
Purchase Date	
Distributor	
Suggestions:	